

South East Asia & South Asia

# 2022 FISHING TACKLE CATALOGUE

**SHIMANO**

## CONTENTS

004-057	REEL
058-061	YUMEYA
062-104	ROD
105-122	LURE/LINE
123-125	APPAREL
126-130	GEAR
131	WARRANTY INFORMATION

The natural environment  
is once  
in a lifetime.

一度として同じ状況はない。

今日という日の出逢いに感謝し、その時を釣る。

それは釣り人にとって永遠の記憶となり、脳裏に刻まれる。





# HAGANE

THIS IS SHIMANO'S BELIEF

YOU INSTANTLY KNOW THE TRUE FEELING  
WHEN CRANKING A SHIMANO, THAT IS THE  
REAL VALUE OF 'HAGANE'

OUR GOAL,  
ETERNALLY SMOOTH REELING.



## HAGANE GEAR

HAGANE GEAR is produced using Shimano's cold forging technology, without any additional machining. This retains the integrity and strength of the material.



## HAGANE BODY

The highly rigid HAGANE BODY protects the gear's rotation performance from heavy load and shock.



"HAGANE" is a keyword to convey the image of our products, and we do not actually use iron materials such as steel.

# INFINITY EVOLUTION



## A solid innovation to manufacturing methodologies for a significant improvement in gear durability.

The latest Infinity Cross technology is based on reformations on designs of gear teeth and the manufacturing methodology used. The surface area of contact between the drive gear and pinion gear has since been increased to distribute the same weight across a wider area of contact. This reduces stress loads at the point of contact and risks of gear teeth damage, doubling the gear system's durability.

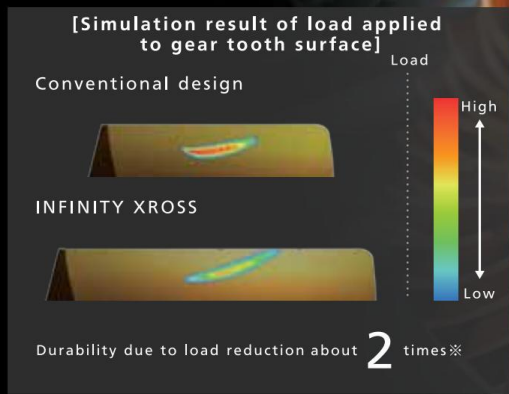

\* Based on our standard gear durability test



## Significant reduction in resistance during line outlay.

By tightening the gaps between internal parts of the reel, the clearance created by upward and downward movements of the spool during line outlays have been reduced, allowing for a neat and more densely packed spool of line. This results in a drop in outlay resistance when line leaves the spool during casts, giving anglers a whole new experience during casts.

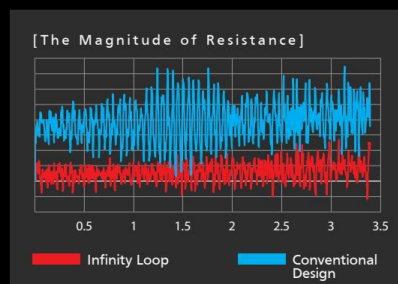



## Light and powerful winding enables anglers to lead the game

Significant reduction in resistance during line outlay.

The Infinity Drive structure is a more advanced version of the conventional X-SHIP structure that created exceptionally light winding. The main shaft, which had previously been supported by the pinion gear, is now supported by a new and unique low-friction bushing that significantly decreases frictional resistance. In addition, the main shaft has undergone a proprietary surface treatment and special processing to drastically reduce rotational torque, constructing a reel that can actively wind even under heavy loads.

\* Based on our comparison test

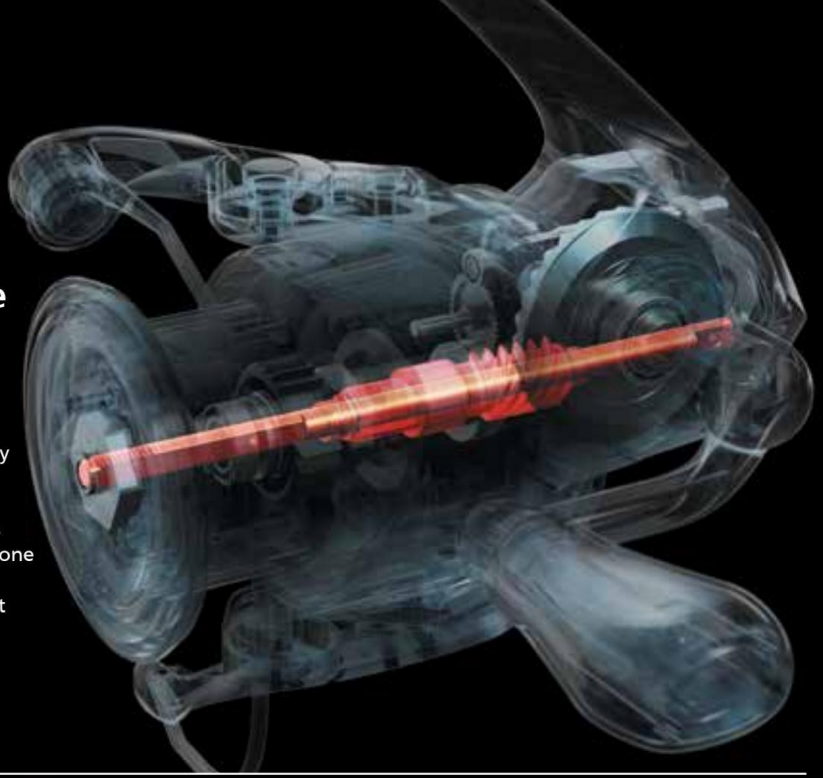

## Enhanced line management for more effective fishing

Anti-Twist Fin

An elastic fin is attached in the vicinity of the line roller. The fin prevents any additional line on the spool from slacking and also prevents them from getting caught under the spool during retrieves/ cranks.



## Impressively anti-friction performance results in a smooth yet reliable drag performance.

Dura-Cross

A newly designed drag washer with a completely new material. The new material is layered onto the existing one in an orthogonal shape to improve the overall strength. The smoothness is kept the same while the anti-friction performance has been increased by more than 10 times\* its preceding renditions.

\*Based on tests with previous models

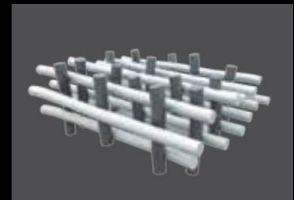

REEL

SPINNING

SPINNING SW

SPINNING SURF

BAITCAST REELS

BAITCAST SW

SW OVERHEAD

ELECTRIC REELS

YUMEYA

# MGL ROTOR

## REDUCES INERTIA AND INCREASES RIGIDITY!

### MAGNUMLITE ROTOR

The Magnumlite Rotor sets new standards in smooth rotation. Reduction in rotation inertia and increased rigidity, this rotor improves drag performance compared to previous designs.



#### MICROMODULE II

We reviewed the teeth design from the most advanced designs, coming up with ideal tooth shape using Shimano unique manufacturing technology. Sound is reduced and smoothness is improved.



#### X-SHIELD

By placing sealing gaskets in 12 critical locations throughout the rigid aluminium body, we are able to create a water resistant structure that can hold up against the toughest conditions.

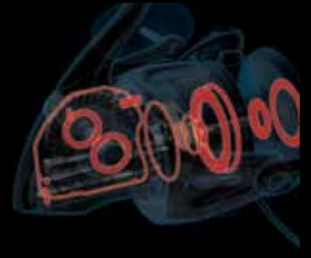

#### AR-C SPOOL

AR-C Spool lip design produces longer casting distances than a standard lip spool, while preventing backlashes and wind knots from forming.



#### X TOUGH DRAG

Incorporating large diameter drag washers at the base of the spool provides great stability. The Coil Wave Spring features steady elasticity at any compression level and little deformation under repeated compression resulting in precise drag adjustments.



#### RIGID SUPPORT DRAG

Rigid Support Drag eliminates spool movement and wobble, even at light drag settings. The result is an incredibly smooth drag even at extremely light settings.



#### PARALLEL BODY

The Parallel Body feature implicates that the spool is lined out parallel to the rod. This results in the reduction of line touching the rod and subsequently increases casting distance.



#### HEATSINK DRAG

Drag force retainment due to Heat Sink Drag: 50%\* improvement! Heat Sink Drag technology results in 30%\* lower spool temperature.

\* Based on internal test by Shimano



#### RIGID CAST TECHNOLOGY

Rigid Cast technology balances strength and lightness of the main shaft to withstand the impact of extreme casting force. This helps improve casting performance and especially accuracy by optimising the timing of line release.

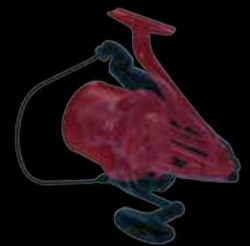

#### SILENT DRIVE

All driving parts are re-examined thoroughly, eliminating any minute gaps, looseness and shakes, improving the drive gear, worm shaft, worm shaft pins, worm shaft gear and so on. A new dimension of smoothness is achieved with the added comfort of quietness.

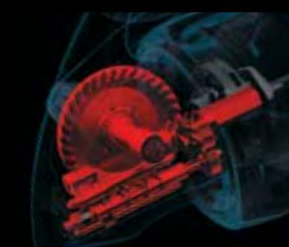

#### ONE-PIECE BAIL

One-Piece Bail allows the line to travel unimpeded to the line roller. Its seamless design reduces friction and the chance of tangles or cut to the bail arm.







# SMOOTHNESS AND WATERPROOFNESS, TRUSTWORTHY STRUCTURE

## X PROTECT

New Stella is equipped with X Protect. We achieved high waterproof performance by using water repellent coating and labyrinth structure to prevent water from entering the inner area of the reel.

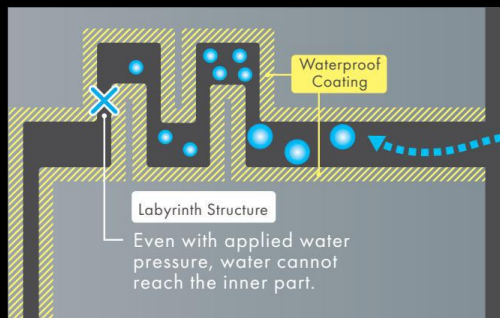

## LARGE SIZED SALTWATER REELS

To achieve a greater level of water resistance on larger sized saltwater reels, a seal to sever off the route of seawater into the reel is used. The grease used not only improves the water resistance structure but also maintains a smooth and light reeling experience for the angler. X protect can be found on the line roller and stopper bearings. \*Stopper bearings with X protect has IPX8-rated water resistance structure.

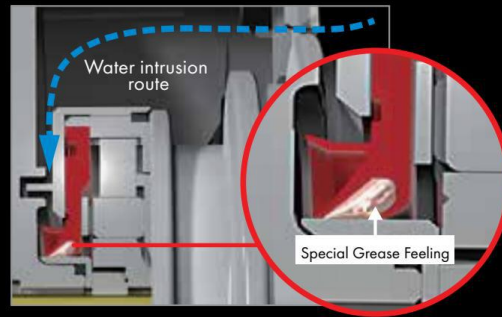

## LIST OF SPINNING REEL MODELS

C3000	S	HG	DH
MODEL	SPOOL TYPE	GEAR RATIO	HANDLE TYPE
C: Compact body	SSS: Special shallow pool SS: Super Shallow Pool S: Shallow pool M: Medium deep spool Unmarked: Deep spool	PG: Power gear Unmarked: Normal gear HG: High gear XG: Extra High Gear XXG: Double Extra High Gear	Unmarked: Single handle DH: Double handle

### SMALL AND MEDIUM-SIZED SPINNING REELS SIZE CHART AND APPLICATIONS

Model	Spool Type	Body Size	Applications
1000	1000	1000	Peacock Bass, Rockfish, Sebarau, Mangrove Jack
C2000	C2000		Bass, Eging, Peacock Bass, Rockfish, Sebarau
C2500	C2500	2500	Eging, Snakehead, Peacock Bass, Sebarau
2500	2500		Peacock Bass, Toman, Eging, Sebarau
C3000	C3000	4000	Sebarau, Toman, Shore Jigging, Light Jigging
3000	3000		
4000	4000		
C5000	C5000		

### LARGE SPINNING REELS SIZE CHART AND APPLICATIONS

Model	Spool Type	Body Size	Applications
4000	4000	5000	Light Jigging, Shore Jigging, Seabass
5000	5000		
6000	6000		
8000	8000	10000	Offshore (Jigging/ Casting), Rock Shore
10000	10000		
14000	14000		
18000	18000	20000	Offshore (Jigging/ Casting), Amberjack, GT, Tuna
20000	20000		

REEL

SPINNING

SPINNING SW

SPINNING SURF

BAITCAST REELS

BAITCAST SW

SW OVERHEAD

ELECTRIC REELS

YUMEYA

# STELLA



2500S

## INFINITY EVOLUTION

The latest Infinity Cross technology is based on reformations on designs of gear teeth and the manufacturing methodology used. The Infinity Loop helps in condensing line on the spool and reduces the resistance during outlay while the Infinity Drive provides significantly more rotational power even with large loads on the other end of the line. With the integration of these technologies on the top line of Shimano's spinning reels - STELLA has achieved newer heights with this latest rendition! Line troubles around the spool are also minimized with the anti-twist fin while the DuraCross allows for excellent drag performance. Rest assured that the reels in this lineup have been polished to the finest tier on every front, inside and out!



STELLA						NEW
Model Number	Line Capacity PE [no.-m]	Gear Ratio	Weight [g]	Max Drag [kg]	Bearings	
1000	0.8-240, 1-190	5.1	165	3.0	12/1	
1000SPG	0.3-140, 0.4-100, 0.6-80	4.4	165	3.0	12/1	
C2000S	0.6-150, 0.8-110, 1-80	5.1	170	3.0	12/1	
C2000SHG	0.6-150, 0.8-110, 1-80	6.0	170	3.0	12/1	
C2500S	0.6-200, 0.8-150, 1-120	5.1	175	3.0	12/1	
C2500SXG	0.6-200, 0.8-150, 1-120	6.3	175	3.0	12/1	
2500S	0.6-200, 0.8-150, 1-120	5.1	205	4.0	12/1	
2500SHG	0.6-200, 0.8-150, 1-120	5.8	205	4.0	12/1	
2500	1-320, 1.2-270, 1.5-220	5.1	210	9.0	12/1	
C3000SDH	0.6-200, 0.8-150, 1-120	5.1	220	9.0	14/1	
C3000SDHHG	0.6-200, 0.8-150, 1-120	5.8	220	9.0	14/1	
C3000MHG	1-190, 1.2-150, 1.5-120	5.8	210	9.0	12/1	
C3000XG	1-400, 1.5-270, 2-200	6.4	210	9.0	12/1	
3000MHG	1-190, 1.2-150, 1.5-120	5.7	235	9.0	12/1	
4000M	1.2-250, 1.5-200, 2-150	5.3	260	11.0	12/1	
4000MHG	1.2-250, 1.5-200, 2-150	5.7	260	11.0	12/1	
4000XG	1-490, 1.5-320, 2-240	6.2	260	11.0	12/1	
C5000XG	1.5-400, 2-300, 3-200	6.2	260	11.0	12/1	

\* There is no stopper switching mechanism.

# TWIN POWER



C3000XG

## HIGH RIGIDITY AND DURABILITY

The Twin Power has been one of the top in Shimano's lineup for the past 30 years. To breakthrough, we had to create a reel that is stronger than before. To achieve this, we decided to equip the new Twin Power with a metal rotor to maximize rigidity of the reel. Paired with the HAGANE Body, this lineup has unparalleled durability and rigidity made specially for fights with pelagic. When cranking the all new Twin Power, some will sense familiarity as the lineup offers reels with Stella-grade smoothness and reeling experience. In addition, the long stroke spool helps in achieving greater casting distances. A trusty and tough reel suitable for use in multiple fields and situations, the Twin Power has evolved to new heights, marking the start of a new chapter.



TWINPOWER					
Model Number	Line Capacity PE [no.-m]	Gear Ratio	Weight [g]	Max Drag [kg]	Bearings
1000	0.8-240, 1-190	5.1	175	3.0	9/1
C2000S	0.6-150, 0.8-110, 1-80	5.1	180	3.0	9/1
C2000SHG	0.6-150, 0.8-110, 1-80	6.1	180	3.0	9/1
2500	1-320, 1.2-270, 1.5-220	5.3	210	9.0	9/1
2500SHG	0.6-200, 0.8-150, 1-120	6.0	210	4.0	9/1
C3000	1-400, 1.5-270, 2-200	5.3	215	9.0	9/1
C3000XG	1-400, 1.5-270, 2-200	6.4	215	9.0	9/1
4000	1-490, 1.5-320, 2-240	5.3	255	11.0	9/1
4000PG	1-490, 1.5-320, 2-240	4.4	260	11.0	9/1
4000XG	1-490, 1.5-320, 2-240	6.2	260	11.0	9/1
C5000XG	1.5-400, 2-300, 3-200	6.2	260	11.0	9/1

\* There is no stopper switching mechanism.

# Vanquish

MGL  
MAGNUMLITE



C3000XG

Lightness, Strength and Casting Distance like never seen before.

Unwavering at the top of the Magnumlite Series. From the body to the rotor and even the handle, it was a pursuit of making every part of the reel lighter than before. The result was an overwhelming success with the new models being much lighter than all its predecessors. With this new found lightness, the operability and overall feel of the reel has been greatly improved.



VANQUISH					
Model Number	Line Capacity PE [no.-m]	Gear Ratio	Weight [g]	Max Drag [kg]	Bearings
100SSSPG	0.3-120, 0.4-90	4.6	145	3.0	11/1
C2000S	0.6-150, 0.8-110, 1-80	5.1	145	3.0	11/1
C2000SS	0.3-140, 0.4-100, 0.6-80	5.1	145	3.0	11/1
C2000SHG	0.6-150, 0.8-110, 1-80	6.1	145	3.0	11/1
C2500SHG	0.6-200, 0.8-150, 1-120	6.0	155	3.0	11/1
C2500SXG	0.6-200, 0.8-150, 1-12	6.4	155	3.0	11/1
2500S	0.6-200, 0.8-150, 1-120	5.3	165	4.0	11/1
2500SHG	0.6-200, 0.8-150, 1-120	6.0	165	4.0	11/1
C3000	1-400, 1.5-270, 2-200	5.3	170	9.0	11/1
C3000MHG	1-190, 1.2-150, 1.5-120	6.0	170	9.0	11/1
C3000SDH	0.6-200, 0.8-150, 1-120	5.3	175	9.0	13/1
C3000SDHGG	0.6-200, 0.8-150, 1-120	6.0	175	9.0	13/1
C3000XG	1-400, 1.5-270, 2-200	6.4	170	9.0	11/1
3000MHG	1-190, 1.2-150, 1.5-120	5.8	185	9.0	11/1
4000MHG	1.2-250, 1.5-200, 2-150	5.8	205	11.0	11/1
4000XG	1-490, 1.5-320, 2-240	6.2	200	11.0	11/1
C5000HG	1.5-400, 2-300, 3-200	5.8	220	11.0	11/1
C5000XG	1.5-400, 2-300, 3-200	6.2	220	11.0	11/1

\* There is no stopper switching mechanism.

# TWIN POWER XD

MGL  
MAGNUMLITE



C5000XG

The strongest in the MGL series. A lighter and tougher Twin Power XD.

The New Twin Power XD is lighter than ever before while still retaining its logic-defying durability. Refining the reel's fundamental specs, performance is greatly improved with Shimano's latest technologies – Micromodule Gear II, Long Stroke Spool and Silent Drive. The tough drive gear system backed by carbon cross washers is coupled with the barrier coated spooling system (used in Stella SW spooling system!). This makes the reel so much tougher and comfortable across all models in the line-up. Experience the toughness of what Shimano proudly calls MGL's strongest!



TWINPOWER XD					
Model Number	Line Capacity PE [no.-m]	Gear Ratio	Weight [g]	Max Drag [kg]	Bearings
C3000HG	1-400, 1.5-270, 2-200	6.0	200	9.0	10/1
C3000XG	1-400, 1.5-270, 2-200	6.4	200	9.0	10/1
4000PG	1-490, 1.5-320, 2-240	4.4	245	11.0	10/1
4000HG	1-490, 1.5-320, 2-240	5.8	245	11.0	10/1
4000XG	1-490, 1.5-320, 2-240	6.2	245	11.0	10/1
C5000XG	1.5-400, 2-300, 3-200	6.2	245	11.0	10/1

\* There is no stopper switching mechanism.

REEL

SPINNING

SPINNING SW

SPINNING SURF

BAITCAST REELS

BAITCAST SW

SW OVERHEAD

ELECTRIC REELS

YUMEYA

# CARDIFF C14+



1000SHG

A special tune developed for Ultra Light gamers.

Stabilised outgoing line with the Rigid Support Drag technology, a fine tuned area drag and exhilarating drag sounds. These form the drag system on the reel which is targeted towards the Ultra-Light Fishing lovers. All models are equipped with the NEW Magnumlite Rotor.



※ 1 : C3000MHG ※ 2 : 1000S, 1000SHG

CARDIFF C14+						
Model Number	Line Capacity PE [no.-m]	Gear Ratio	Weight [g]	Max Drag [kg]	Bearings	
1000S	0.6-140, 0.8-100, 1-70	5.0	170	3.0	9/1	
1000SHG	0.6-140, 0.8-100, 1-70	6.0	170	3.0	9/1	
C3000MHG	1-220, 1.2-150, 1.5-135	6.0	200	9.0	9/1	

## Strong & Sensitive

Strong yet sensitive aren't words typically defining an aesthetic show-stopper. But they do illustrate the newly-redesigned Sustain series of spinning reels built to conquer the toughest inshore or freshwater species. One of the strongest in the MagnumLite series of spinning reels, Shimano engineered the Sustain with a redesigned MagnumLite (MGL) Rotor for light start-up rotation and faster hooksets with increased sensitivity. The increased strength of an Aluminum HAGANE Body reduces reel flex when winding against hard-fighting game fish. Lighter than its predecessor, the Sustain now features Long Stroke Spool to provide anglers with improved casting distance. MicroModule II gearing combined with Shimano's HAGANE Gear and SilentDrive technologies offer anglers smooth reeling performance.



SUSTAIN <span style="float: right;">NEW</span>						
Model Number	Power Pro Capacity [lb-yds]	Gear Ratio	Weight [g]	Max Drag [kg]	Bearings	
2500	10-150, 15-145, 30-100	5.3	210	9.0	8/1	
2500HG	10-150, 15-145, 30-100	6.0	210	9.0	8/1	
C3000	10-200, 20-140, 40-105	5.3	210	9.0	8/1	
C3000HG	10-200, 20-140, 40-105	6.0	210	9.0	8/1	
C3000XG	10-200, 20-140, 40-105	6.4	210	9.0	8/1	
4000	15-230, 30-180, 50-120	5.3	260	11.0	8/1	
4000HG	15-230, 30-180, 50-120	5.8	260	11.0	8/1	
4000XG	15-230, 30-180, 50-120	6.2	265	11.0	8/1	
C5000XG	20-260, 30-235, 40-185	6.2	270	11.0	8/1	

## Super Fast!

The all new Vanford is designed to become the ultimate finesse fishing reel with a super-fast start up. Replacing the iconic Stradic Ci4+, this reel is equipped with a range of technology upgrades that sets the Vanford apart. Still drawing upon a lightweight Ci4+ body construction, the new MGL rotor makes the reel 48% lighter to turn when compared to a standard rotor design. X-Protect provides high-level water resistance.



VANFORD						
Model Number	Power Pro Capacity [lb-yd]	Gear Ratio	Weight [g]	Max Drag [kg]	Bearings	
500	5-135, 8-105, 10-65	5.6	140	2.5	6/1	
1000	10-95, 15-75, 20-65	5.1	150	3.0	7/1	
C2000S	3-125, 4-105, 5-90	5.1	150	3.0	7/1	
C2000HG	10-140, 15-115, 20-95	6.1	150	3.0	7/1	
C2000SHG	3-125, 4-105, 5-90	6.1	150	3.0	7/1	
2500	10-150, 15-145, 30-100	5.3	180	9.0	7/1	
2500HG	10-150, 15-145, 30-100	6.0	180	9.0	7/1	
2500SHG	5-140, 8-120, 10-85	6.0	175	4.0	7/1	
C3000	10-200, 20-140, 40-105	5.3	180	9.0	7/1	
C3000HG	10-200, 20-140, 40-105	6.0	180	9.0	7/1	
C3000XG	10-200, 20-140, 40-105	6.4	180	9.0	7/1	
4000	15-230, 30-180, 50-120	5.3	215	11.0	7/1	
4000XG	15-230, 30-180, 50-120	6.2	215	11.0	7/1	
C5000XG	20-260, 30-235, 40-185	6.2	220	11.0	7/1	

# SUSTAIN



4000HG

# VANFORD



2500SHG

# STRADIC

CORESOLID



C3000XG



## Continuous Evolution

Featuring Silent Drive and Micromodule Gear II, the Stradic's reeling performance now approaches flagship level. For the first time in Stradic's class, Shimano has implemented a Long Stroke Spool for improved casting distance. Durability has been further improved by raising gear strength and adopting X PROTECT water

STRADIC					
Model Number	Power Pro Capacity [lb-yd]	Gear Ratio	Weight [g]	Max Drag [kg]	Bearings
1000S	3-115, 4-95, 5-80	5.1	185	3.0	6/1
1000	10-95, 15-85, 20-65	5.0	185	3.0	6/1
1000HG	10-95, 15-85, 20-65	6.0	185	3.0	6/1
C2000S	3-125, 4-105, 5-90	5.1	185	3.0	6/1
C2000SHG	3-125, 4-105, 5-90	6.1	185	3.0	6/1
2500	10-150, 15-145, 30-100	5.0	220	9.0	6/1
2500S	5-140, 8-120, 10-85	5.3	220	4.0	6/1
2500HG	10-150, 15-145, 30-100	6.0	225	9.0	6/1
C3000	10-200, 20-140, 40-105	5.0	225	9.0	6/1
C3000HG	10-200, 20-140, 40-105	6.0	225	9.0	6/1
C3000XG	10-200, 20-140, 40-105	6.4	225	9.0	6/1
4000	15-280, 30-170, 50-150	4.8	280	11.0	6/1
4000XG	15,280, 30-170, 50-150	6.2	280	11.0	6/1
C5000XG	20-260,30-235,40-185	6.2	295	11.0	6/1

# ULTEGRA

CORESOLID



C3000



The new Ultegra is a feature-packed powerhouse, offering premium performance for all anglers.

The sleeping giant rests no longer. Ruggedly designed from cover to core with a hint of elegance in design, the marriage of Shimano's CI4+ composite body and cold-forged HAGANE Gear provides extreme durability and sensitivity with less weight. MicroModule Gear II and SilentDrive technologies improve gear mesh and minimize overall play in construction to provide increased reel performance.

ULTEGRA					
Model Number	Power Pro Capacity [lb-yd]	Gear Ratio	Weight [g]	Max Drag [kg]	Bearings
1000	10-95, 15-75, 20-65	5.1	180	3.0	5/1
C2000S	3-125, 4-105, 5-90	5.1	185	3.0	5/1
C2000HG	10-140, 15-115, 20-95	6.1	185	3.0	5/1
C2000SHG	3-125, 4-105, 5-90	6.1	225	3.0	5/1
2500	10-150, 15-145, 30-100	5.3	225	9.0	5/1
2500HG	10-150, 15-145, 30-100	6.0	220	9.0	5/1
2500SHG	5-140, 8-120, 10-85	6.0	225	4.0	5/1
C3000	10-200, 20-140, 40-105	5.3	225	9.0	5/1
C3000HG	10-200, 20-140, 40-105	6.0	225	9.0	5/1
C3000XG	10-200, 20-140, 40-105	6.4	225	9.0	5/1
4000	15-230, 30-180, 50-120	5.3	270	11.0	5/1
4000XG	15-230, 30-180, 50-120	6.2	270	11.0	5/1
C5000XG	20-260, 30-235, 40-185	6.2	285	11.0	5/1

# NASCI



C3000HG



The new Nasci series of spinning reels answers the call for anglers demanding smoothness and durability in multiple fishing applications.

The new Nasci series of spinning reels answers the call for anglers demanding smoothness and durability in multiple fishing applications. Suitable in both freshwater and inshore saltwater environments, Nasci spinning reels feature CoreProtect to increase durability and water resistance without creating any additional heavy rotational feeling. The Shimano cold-forged HAGANE Gear technology provides unparalleled gear durability compared to reels with diecast or machined gear construction. SilentDrive — the same technology found in Shimano's flagship lineup of reels — increases gear tolerances to a micron level to reduce unnecessary noise and vibration for increased reeling performance. Engineered to perform with quality and attention to detail, the newly redesigned series of Nasci spinning reels will perform when needed most.

NASCI					
Model Number	Power Pro Capacity [lb-yd]	Gear Ratio	Weight [g]	Max Drag [kg]	Bearings
500	5-135, 8-105, 10-65	5.6	170	3.0	4/1
1000	10-95, 15-75, 20-65	5.0	205	3.0	5/1
C2000S	3-125, 4-105, 5-90	5.0	210	3.0	5/1
C2000SHG	3-125, 4-105, 5-90	6.0	210	3.0	5/1
2500	10-150, 15-145, 30-100	5.0	240	9.0	5/1
2500HG	10-150, 15-145, 30-100	6.2	240	9.0	5/1
2500SHG	5-140, 8-120, 10-85	6.2	240	4.0	5/1
C3000	10-200, 20-140, 40-105	5.0	240	9.0	5/1
C3000HG	10-200, 20-140, 40-105	5.0	240	9.0	5/1
C3000DH	10-200, 20-140, 40-105	6.2	270	9.0	5/1
4000	15-230, 30-180, 50-120	4.7	285	11.0	5/1
4000XG	15-230, 30-180, 50-120	6.2	285	11.0	5/1
C5000XG	20-260, 30-235, 40-185	6.2	305	11.0	5/1

REEL  
SPINNING  
SPINNING SW  
SPINNING SURF  
BAITCAST REELS  
BAITCAST SW  
SW OVERHEAD  
ELECTRIC REELS  
YUMEYA

# SAHARA



C3000HG

With features outperforming its class, the SAHARA lineup is versatile and made for use in different situations!

The AR-C spool not only aids in reducing line troubles but also helps in further casting distances. The screw-in handle complemented with the reel's Silent Drive technology gives the angler a sturdy yet smooth reel for a comfortable cranking experience during fights with fish. This is crucial for lure fishing because if there is looseness or play when retrieving lures, you will not be able to accurately grasp the situation underwater. A C5000XG model with a rounded handle knob is included in this versatile lineup, from size 500 all the way to C5000.



※ 1 : EXCLUDING 500

SAHARA						NEW
Model Number	Power Pro Capacity [lb-yd]	Gear Ratio	Weight [g]	Max Drag [kg]	Bearings	
500	5-135, 8-105, 10-65	5.6	170	3.0	3/1	
1000	10-95, 15-75, 20-65	5.0	205	3.0	4/1	
C2000S	3-125, 4-105, 5-90	5.0	210	3.0	4/1	
C2000SHG	3-125, 4-105, 5-90	6.0	210	3.0	4/1	
2500	10-150, 15-145, 30-100	5.0	240	9.0	4/1	
2500SHG	5-140, 8-120, 10-85	6.2	240	4.0	4/1	
C3000	10-200, 20-140, 40-105	5.0	240	9.0	4/1	
C3000HG	10-200, 20-140, 40-105	6.2	240	9.0	4/1	
C3000DH	10-200, 20-140, 40-105	5.0	265	9.0	4/1	
4000	15-230, 30-180, 50-120	4.7	280	11.0	4/1	
4000XG	15-230, 30-180, 50-120	6.2	280	11.0	4/1	
C5000XG	20-260, 30-235, 40-185	6.2	305	11.0	4/1	

# SEDONA



6000

At the heart of the Sedona FI line of spinning reels is Shimano's state-of-the-art technology, the HAGANE Gear.

Incorporating HAGANE cold-forging technology into the Sedona FI gives it a step up from other reels in its class and provides long-lasting smoothness and durability for assured resilience even after countless battles with your target species. The Sedona FI series includes models for everything from light freshwater to heavier offshore species thanks to improved drag power and increased gear ratios.



※ 1 : Excluding 500

SEDONA					
Model Number	Power Pro Capacity [lb-yd]	Gear Ratio	Weight [g]	Max Drag [kg]	Bearings
500	5-135, 8-105, 10-65	5.6	175	3.0	3/1
1000	15-85, 20-65	5.0	215	3.0	3/1
2500	10-150, 15-145, 30-100	5.0	245	4.0	3/1
2500HG	10-150, 15-145, 30-100	6.2	245	4.0	3/1
C3000	10-200, 40-140, 40-105	5.0	250	9.0	3/1
C3000HG	10-200, 40-140, 40-105	6.2	250	9.0	3/1
4000	15-280, 30-170, 50-150	4.7	295	11.0	3/1
4000XG	15-280, 30-170, 50-150	6.2	295	11.0	3/1
C5000XG	20-220, 30-200, 40-160	6.2	300	11.0	3/1
6000	30-290, 50-195, 65-140	4.6	425	11.0	3/1
8000	40-340, 50-265, 65-215	4.9	600	11.0	3/1

# NEXAVE



2500

Reliable Shimano quality. Highly durable entry model.

The new Nexave FI is the updated version of the well-known Nexave FE. This new reel is a front drag spinning reel which can be used for all kinds of freshwater fishing, from fishing light to moderate lures for trout, perch, pike and zander up to match and feeder fishing. Due to the 3 shielded stainless steel ball bearings the reel runs smooth and as can be expected from a real Shimano reel, the drag is perfectly adjustable and will help you fight big fish without any problems. Nexave is also an affordable reel for anglers who have just started fishing and want to experience the quality of Shimano reels.



NEXAVE						NEW
Model Number	Power Pro Capacity [lb-yd]	Gear Ratio	Weight [g]	Max Drag [kg]	Bearings	
1000	10-95, 15-75, 20-65	5.0	220	3.0	3/1	
C2000S	3-125, 4-105, 5-90	5.0	225	3.0	3/1	
2500	10-150, 15-145, 30-100	5.0	250	4.0	3/1	
2500HG	10-150, 15-145, 30-100	6.2	250	4.0	3/1	
2500S	5-140, 8-120, 10-85	5.0	265	4.0	3/1	
C3000	10-200, 20-140, 40-105	5.0	255	9.0	3/1	
C3000HG	10-200, 20-140, 40-105	6.2	255	9.0	3/1	
4000	15-230, 30-180, 50-120	5.2	305	11.0	3/1	
4000HG	15-230, 30-180, 50-120	5.8	305	11.0	3/1	
C5000HG	20-260, 30-235, 40-185	5.8	305	11.0	3/1	

# CATANA



2500

Offering exceptional value for money the Catana is a freshwater and in-shore saltwater spinning reel that can be used for all kinds of freshwater fishing.

If you are looking for a freshwater spinning reel at a very affordable price, the Catana FE is one option you should not ignore. Ideal for a wide range of fishing, from lightweight and medium sized lures, to match and feeder fishing, the understated appearance looks fantastic and the performance is remarkable for a reel of this price. Pair the Catana with any low and mid-priced Shimano rod and you have a great combination that you will be proud to own and use.



CATANA <span style="float: right;">NEW</span>					
Model Number	Power Pro Capacity [lb-yd]	Gear Ratio	Weight [g]	Max Drag [kg]	Bearings
1000	10-95, 15-75, 20-65	5.0	230	3.0	3/1
2500	10-150, 15-145, 30-100	5.0	260	4.0	3/1
2500HG	10-150, 15-145, 30-100	6.2	260	4.0	3/1
C3000	10-200, 20-140, 40-105	5.0	260	8.5	3/1
C3000HG	10-200, 20-140, 40-105	6.2	260	8.5	3/1
4000	15-230, 30-180, 50-120	5.2	320	8.5	3/1
4000HG	15-230, 30-180, 50-120	5.8	320	8.5	3/1

# SIENNA



2500

Sienna is a well-balanced, well-built, high-performance reel at an amazingly affordable price.

This reel incorporates the Propulsion Line Management system for longer casts and reduced wind knots, and Super Stopper II for instant anti-reverse with no back play. Sienna is perfectly suited for everything from freshwater to inshore fishing.



SIENNA					
Model Number	Power Pro Capacity [lb-yd]	Gear Ratio	Weight [g]	Max Drag [kg]	Bearings
500	5-135, 8-105, 10-65	5.6	180	2.0	3/1
1000	10-95, 15-85, 20-65	5.0	185	3.0	3/1
2000	10-140, 15-115, 20-95	5.0	250	4.0	3/1
2500	10-150, 15-145, 30-100	5.0	250	4.0	3/1
2500HG	10-150, 15-145, 30-100	6.2	250	4.0	3/1
C3000	10-200, 20-140, 40-105	5.0	250	8.5	3/1
4000	15-230, 30-180, 50-120	5.2	320	8.5	3/1

# FX



2000

Safe, comfortable and trouble-free. No doubt an introductory machine.

Now with a roller clutch, propulsion spool and an increased bearing count, you'll get more performance features for less with the FX series.



FX					
Model Number	Power Pro Capacity [lb-yd]	Gear Ratio	Weight [g]	Max Drag [kg]	Bearings
1000	10-95, 15-85, 20-65	5.0	205	3.0	2/1
2000	10-140, 15-115, 20-95	5.0	250	4.0	2/1
2500	10-150, 15-145, 30-100	5.0	250	4.0	2/1
2500HG	10-150, 15-145, 30-100	5.0	250	4.0	2/1
C3000	10-200, 20-140, 40-105	5.0	250	8.5	2/1
4000	15-230, 30-180, 50-120	5.2	320	8.5	2/1

# STELLA SW



14000XG

## Absolute Power.

Shimano Stella SW Spinning Reels are the latest edition to the legacy of Stella Spinning Reels that have led the fishing world in durability, power and operability. Shimano builds on that tradition with cutting edge technologies bringing further unmatched strength, reliability and ease of use to serious saltwater anglers. Featuring Shimano's signature HAGANE Body, Stella SW boasts a highly rigid metal construction. At the heart of the reel, Shimano certified HAGANE Gears are cold forged for lasting durability and smoothness. For even better drag performance, Shimano's new Heat Sink Drag transfers heat away from the spool, reducing spool surface temperature by up to 100 degrees Fahrenheit.

Stella SW's IPX8 waterproof body along with X-Protect and X-Shield's water resistant construction in the line roller and roller bearing, guard your investment against the harsh elements of a saltwater environment so you can fish with confidence.



STELLA SW						NEW
Model Number	Line Capacity PE [no.-m]	Gear Ratio	Weight [g]	Max Drag [kg]	Bearings	
4000HG	1-490, 1.5-320, 2-240	5.7	355	11.0	12/1	
4000XG	1-490, 1.5-320, 2-240	6.2	355	11.0	12/1	
5000HG	2-350, 3-240, 4-170	5.7	420	13.0	13/1	
5000XG	2-350, 3-240, 4-170	6.2	420	13.0	13/1	
6000PG	2-440, 3-300, 4-210	4.6	425	13.0	13/1	
6000HG	2-440, 3-300, 4-210	5.7	425	13.0	13/1	
6000XG	2-440, 3-300, 4-210	6.2	425	13.0	13/1	
8000PG	3-410, 4-300, 5-250	4.9	625	25.0	13/1	
8000HG	3-410, 4-300, 5-250	5.6	625	25.0	13/1	
10000PG	4-400, 5-300, 6-250	4.9	670	25.0	13/1	
10000HG	4-400, 5-300, 6-250	5.6	670	25.0	13/1	
14000PG	6-300, 8-200, 10-165	4.9	675	25.0	13/1	
14000XG	6-300, 8-200, 10-165	6.2	675	25.0	13/1	
18000HG	5-500, 6-400, 8-300	5.7	875	28.0	13/1	
20000PG	5-600, 6-500, 8-350	4.4	885	28.0	13/1	
30000	8-600, 10-475, 12-375	4.4	975	25.0	13/1	

# TWIN POWER SW



14000XG

## Challenge the impossible.

The inclusion of Infinity Drive reduces handle rotation torque by a maximum of 30% when compared to the previous series. Heat Sink Drag features in the 10000 and 14000 sizes to reduce the amount of heat transferred to the drag washers and line during the fight. The X-Protect seal and labyrinth structure repels water intrusion, with the line roller and clutch assembly, the mechanism is more than ten times more durable according to Shimano internal tests. The new striking silver and blue cosmetics have been paired up with a polished metal handle and power knob to finish the reel off superbly. Engineered to the highest standard for the world's hardest fighting saltwater species.



※1 : 10000PG, 10000HG, 14000PG, 14000XG only ※2 : Excluding 4000XG

TWIN POWER SW					
Model Number	Line Capacity PE [no.-m]	Gear Ratio	Weight [g]	Max Drag [kg]	Bearings
4000XG	1-490, 1.5-320, 2-240	6.2	350	11.0	9/1
5000HG	2-350, 3-240, 4-170	5.7	415	13.0	10/1
5000XG	2-350, 3-240, 4-170	6.2	415	13.0	10/1
6000PG	2-440, 3-300, 4-210	4.6	420	13.0	10/1
6000HG	2-440, 3-300, 4-210	5.7	420	13.0	10/1
6000XG	2-440, 3-300, 4-210	6.2	420	13.0	10/1
8000PG	3-410, 4-300U, 5-250	4.9	615	25.0	10/1
8000HG	3-410, 4-300, 5-250	5.6	615	25.0	10/1
10000PG	4-400, 5-300, 6-250	4.9	655	25.0	10/1
10000HG	4-400, 5-300, 6-250	5.6	655	25.0	10/1
14000PG	6-300, 8-200, 10-165	4.9	660	25.0	10/1
14000XG	6-300, 8-200, 10-165	6.2	660	25.0	10/1



# STRADIC SW



5000XG

Specs designed to cater for exciting SW game.

Light cranking feel yet strong build and power, fight with fish on your terms with the Infinity Drive technology! X protect shuts out water from entering the inner chambers of the reel, making the reel more durable than ever before. A truly strong and durable fighter for the next-level off shore game!



※1 : Excluding 4000HG, 4000XG ※2 : 4000HG, 4000XG only

STRADIC SW						
Model Number	Line Capacity PE [no.-m]	Gear Ratio	Weight [g]	Max Drag [kg]	Bearings	
4000XG	1-490, 1.5-320, 2-240	6.2	350	11.0	9/1	
5000HG	2-350, 3-240, 4-170	5.7	415	13.0	10/1	
5000XG	2-350, 3-240, 4-170	6.2	415	13.0	10/1	
6000PG	2-440, 3-300, 4-210	4.6	420	13.0	10/1	
6000HG	2-440, 3-300, 4-210	5.7	420	13.0	10/1	
6000XG	2-440, 3-300, 4-210	6.2	420	13.0	10/1	
8000PG	3-410, 4-300, 5-250	4.9	615	25.0	10/1	
8000HG	3-410, 4-300, 5-250	5.6	615	25.0	10/1	
10000PG	4-400, 5-300, 6-250	4.9	655	25.0	10/1	
10000HG	4-400, 5-300, 6-250	5.6	655	25.0	10/1	
14000PG	6-300, 8-200, 10-165	4.9	660	25.0	10/1	
14000XG	6-300, 8-200, 10-165	6.2	660	25.0	10/1	

# SARAGOSA SW



8000HG

Unmatched Durability.

The Saragosa SW has built an incredible reputation and the new released model takes it to the next level. Packed with upgrades to deliver great cranking power and unmatched durability, no other reel compares at this price point. The Saragosa SWA series features 8 models with the 14000XG and 18000HG being new additions for 2020. The new range incorporates top tier Shimano technologies such as X-Protect, X-Ship, Hagane Body and Hagane gear into its lightweight compact body. The newly designed compact body has been engineered to reduce the weight across the entire series, improving the reels handling and balance. Drawing upon the Stella SWC, Infinity Drive is included and provides improved pinion gear support which translates to greater and smoother cranking power. Built for big fish in extreme conditions, the Saragosa SWA will continue to push the boundaries.



SARAGOSA SW						
Model Number	PowerPro Capacity [lb-yd]	Gear Ratio	Weight [g]	Max Drag [kg]	Bearings	
5000XG	20-245, 30-225, 40-175	6.2	450	10.0	5/1	
6000HG	30-295, 50-195, 65-140	5.7	455	10.0	5/1	
8000HG	40-340, 50-265, 65-215	5.6	675	16.0	5/1	
10000PG	50-360, 65-290, 80-215	4.9	690	15.0	5/1	
14000XG	50-400, 65-315, 80-240	6.2	700	15.0	5/1	
18000HG	50-600, 65-440, 80-360	5.7	915	22.0	6/1	
20000PG	65-490, 80-400, 100-340	4.4	935	22.0	6/1	
25000	65-630, 80-520, 100-440	4.4	960	20.0	6/1	

# SPHEROS SW



4000XG



6000HG

## Power and Toughness. Massive fish? No problem!

The latest addition to the Spheros SW range comes with power and toughness which will not lose fights against larger fish. The core of this compact SW reel is the cold forged HAGANE gear and its HAGANE body, providing gear strength and smoothness demanded by anglers. With little play in the handle along with highly durable drag washers made of carbon, anglers can feel at ease when fighting against big fish at sea.



※ 1 : Body Only

SPHEROS SW					
Model Number	Line Capacity PE [no.-m]	Gear Ratio	Weight [g]	Max Drag [kg]	Bearings
3000XG	1-400, 1.5-270, 2-200	6.2	255	9.0	3/1
4000HG	1-490, 1.5-320, 2-240	5.8	280	11.0	3/1
4000XG	1-490, 1.5-320, 2-240	6.2	280	11.0	3/1

The Spheros SW is Shimano's entry level saltwater spinning reel and contains many features found on high end models such as X-ship, X-Shield and X-Protect.



SPHEROS SW					
Model Number	Line Capacity PE [no.-m]	Gear Ratio	Weight [g]	Max Drag [kg]	Bearings
5000HG	2-350, 3-240, 4-170	5.7	445	10.0	4/1
6000PG	2-440, 3-300, 4-210	4.6	450	10.0	4/1
6000HG	2-440, 3-300, 4-210	5.7	450	10.0	4/1
8000PG	3-410, 4-300, 5-250	4.9	670	13.0	4/1
8000HG	3-410, 4-300, 5-250	5.6	665	13.0	4/1
10000PG	4-400, 5-300, 6-250	4.9	675	12.0	4/1
14000XG	6-300, 8-200, 10-165	6.2	680	12.0	4/1
20000PG	5-600, 6-500, 8-350	4.4	930	18.0	4/1

# SOCORRO SW



## True durability to tackle nearly anything in the saltwater best describes the Shimano Socorro SW spinning reels.

Equipped with long-lasting HAGANE gearing, the Socorro reels give anglers the strength for both inshore and offshore action, and with X-Ship Technology, they offer the ultimate in smoothness and power.

Fish with confidence. Socorro SW reels are ready.



SOCORRO SW					
Model Number	PowerPro Capacity [lb.-yd]	Gear Ratio	Weight [g]	Max Drag [kg]	Bearings
5000SW	20-245, 30-225, 40-175	4.6	440	10.0	4/1
6000SW	30/290, 50/195, 65/140	4.6	445	10.0	4/1
8000SW	40/340, 50/265, 65/215	4.9	640	12.0	4/1
10000SW	50/360, 65/290, 80/215	4.9	670	12.0	4/1

# Sephia XR

MEL  
MAGNUMLITE



C3000S

Evolution never stops - the Sephia XR is specialized for eging techniques.

The durability to withstand repeatedly aggressive jerk motions. The lightness you feel when eging makes it easy and untiring. The elimination of unnecessary noise in the reel. The Sephia XR displays these elements beautifully. A lightweight and high-strength body molded from Shimano's original material C14+ reinforced with carbon fiber. The Micromodule Gear II provides you with buttery smoothness without compromising any durability on the gear system. Silent Drive suppresses minute vibrations and rattling to refine the smoothness Shimano reels are renowned for. The long stroke spool helps increase casting distances while the Rigid Support Drag helps with the spurts of jet-like speeds squids swim at. Experience this specialized eging reel for yourself!



SEPHIA XR						NEW
Model Number	Line Capacity PE [no.-m]	Gear Ratio	Weight [g]	Max Drag [kg]	Bearings	
C3000S	0.6-200, 0.8-150, 1-120	5.3	175	9.0	9/1	
C3000SHG	0.6-200, 0.8-150, 1-120	6.0	175	9.0	9/1	
C3000SDH	0.6-200, 0.8-150, 1-120	5.3	185	9.0	9/1	
C3000SDHGG	0.6-200, 0.8-150, 1-120	6.0	185	9.0	9/1	

# Sephia SS

MEL  
MAGNUMLITE



C3000S

Sephia SS allows for a smooth cranking experience which is made possible with the HAGANE gears.

It is also equipped with Magnumlite (MGL) rotor allowing for a low moment of inertia as well as Core Protect technology to protect the reel from Saltwater.

Integrated bail with no joints - Beautiful, trouble free and gentle on the line!

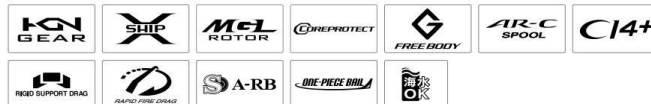

SEPHIA SS					
Model Number	Line Capacity PE [no.-m]	Gear Ratio	Weight [g]	Max Drag [kg]	Bearings
C3000S	0.6-200, 0.8-150, 1-110	5.0	205	9.0	7/1
C3000SHG	0.6-200, 0.8-150, 1-110	6.0	205	9.0	7/1
C3000SDH	0.6-200, 0.8-150, 1-110	5.0	220	9.0	7/1
C3000SDHGG	0.6-200, 0.8-150, 1-110	6.0	220	9.0	7/1

# Sephia BB

CORESOLID



C3000S

Fishing without overlooking the functions of high end models!

The Sephia BB surpasses the limitations of an entry level reel. Other than being able to withstand the hard and quick jerks required during eging, this reel is equipped with HAGANE gears which guarantee durability of the reel and comfort during retrieving.

Features most commonly found on more expensive models such as Core Protect, Rapid Fire Drag and One Piece Bail are all embodied in this reel.



SEPHIA BB					
Model Number	Line Capacity PE [no.-m]	Gear Ratio	Weight [g]	Max Drag [kg]	Bearings
C3000S	0.6-200, 0.8-150, 1-110	5.0	235	9.0	5/1
C3000SHG	0.6-200, 0.8-150, 1-110	6.0	235	9.0	5/1
C3000SDH	0.6-200, 0.8-150, 1-110	5.0	250	9.0	5/1
C3000SDHGG	0.6-200, 0.8-150, 1-110	6.0	250	9.0	5/1

REEL

SPINNING

SPINNING SW

SPINNING SURF

BAITCAST REELS

BAITCAST SW

SW OVERHEAD

ELECTRIC REELS

YUMEYA

# BULL'S EYE



9100

# Activecast



00

# POWER AERO SPIN POWER

## TWIN DRAG



Thick

These reels come from the renowned Power Aero range of reels known for their highly rigid aluminium body that results in little energy loss due to flexing of reel body.

Gears are made by Shimano well known cold forged techniques to ensure that its high quality and last much longer than traditional stamped gears. ARC spool ensures that the line flows out smoothly off the spool when casting for maximum distance.

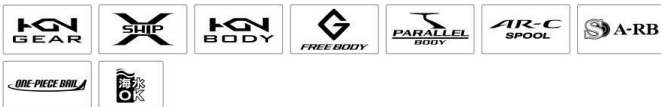

### POWER AERO SPIN POWER TWIN DRAG

Model Number	Line Capacity PE [no.-m]	Gear Ratio	Weight [g]	Max Drag [kg]	Bearings
Standard [Size : 3] Free Spool [Size :5]	1.5-250, 2-200, 3-130 3-225, 4-175, 5-140	3.5	560	19.0	7/1
Thick [Size : 5] Free Spool [Size :8]	3-225, 4-175, 5-140 5-225, 6-185, 8-140	3.5	560	19.0	7/1
Thick+ [Size : 8] Free Spool [Size :10]	5-225, 6-185, 8-140 6-235, 8-175, 10-140	3.5	565	19.0	7/1

Built specifically as a long casting surf and rock fishing reel, this reel was intentionally beefed up in all aspects to make it rugged, reliable and a pleasure to fish with.

Packed with features such as SARB+1 Roller Clutch, a deep CF spool, one piece bail, direct maintenance port and anti-line foiling guard, you know that you can trust this reel to deliver the performance you need.

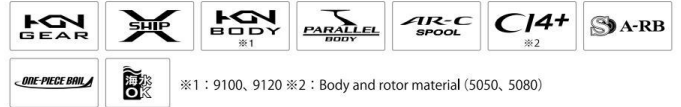

※1 : 9100, 9120 ※2 : Body and rotor material (5050, 5080)

### BULL'S EYE

Model Number	Line Capacity PE [no.-m]	Gear Ratio	Weight [g]	Max Drag [kg]	Bearings
5050	3-225, 4-175, 5-140	4.3	445	12.0	5/1
5080	5-225, 6-185, 8-140	4.3	445	12.0	5/1
9100	6-235, 8-175, 10-140	3.5	540	20.0	5/1
9120	8-200, 10-160, 12-130	3.5	540	20.0	5/1

The Activecast Surf reel is the perfect choice with an affordable price tag for the beginner surf angler.

This reel is suitable for distance casting with a respectable retrieve rate of 3.8:1



### ACTIVECAST

Model Number	Line Capacity PE [no.-m]	Gear Ratio	Weight [g]	Max Drag [kg]	Bearings
1050	3-255, 4-175, 5-140	3.8	650	15.0	4/1
1060	4-225, 5-185, 6-140	3.8	650	15.0	4/1
1080	5-225, 6-185, 8-140	3.8	650	15.0	4/1
1100	6-235, 8-175, 10-130	3.8	650	15.0	4/1
1120	8-200, 10-160, 12-130	3.8	650	15.0	4/1

# POWER AERO PROSURF

## TWIN DRAG



Big pit surfcast reels are the top choices for anglers looking for long cast off the shore. This latest generation weighs in at 600g, a 75g reduction from the previous generation.



### POWER AERO SPIN PROSURF TWIN DRAG

Model Number	Line Capacity PE [no.-m]	Gear Ratio	Weight [g]	Max Drag [kg]	Bearings
Standard [Size : 3] Free Spool [Size :5]	1.5-250, 2-200, 3-130 3-225, 4-175, 5-140	3/5	600	19.0	5/1
Thick [Size : 5] Free Spool [Size :8]	3-225, 4-175, 5-140 5-225, 6-185, 8-140	3.5	600	19.0	5/1
Thick+ [Size : 8] Free Spool [Size :10]	5-225, 6-185, 8-140 6-235, 8-175, 10-140	3.5	600	19.0	5/1

**MEDIUM BAITRUNNER C14+**  
**LC 5500 XTB**  
**BIG BAITRUNNER C14+**  
**LC 14000 XTB**



14000XTB

The big and medium Baitrunner Long Cast series is back and they are fitted with some of Shimano's latest technologies.

Featuring a long cast AR-C spool design and Aero Wrap II, this combination ensures maximum casting performance from the shoreline. X-Ship ensures the smooth function of the internals and HAGANE Gear provides enduring performance.

Fitted with 4/1 Shielded AR-B bearings and available in a 5500 and 14000 size with a drag output of 15kg and 20kg respectively.



MEDIUM/ BIG BAITRUNNER C14+					
Model Number	Power Pro Capacity [lb/yd]	Gear Ratio	Weight [g]	Max Drag [kg]	Bearings
5500XTB	10-425,12-315,16-230	5.3	510	15.0	4/1
14000XTB	12-600,16-440,20-330	4.6	640	20.0	4/1

**BAITRUNNER D**



8000D

The Baitrunner D series incorporate enough power to take on the biggest of fish. Its proprietary Bait Runner function is both reliable & tough under all situations.

Featuring an XT-7 body and rotor, one piece bail, cold forged Aluminium spool and gear, waterproof drag, shielded A-RB, maintenance port and single Bio-mechanical handle.



BAITRUNNER D					
Model Number	Power Pro Capacity [lb-yd]	Gear Ratio	Weight [g]	Max Drag [kg]	Bearings
4000D	15-270, 20-190, 40-145	4.8	380	7.0	3/1
6000D	30-245, 50-210, 65-130	4.8	560	9.0	3/1
8000D	40-295, 50-290, 65-180	4.8	610	9.0	3/1
12000D	50-505,65-310, 80-230	4.4	840	12.0	3/1

**BAITRUNNER OC**



8000OC

OC stands for oceanic.

This is the Baitrunner reel at its rawest form. Rugged features like Cold Forged Aluminium Spool, Oversized Power Roller and the legendary Shimano Baitrunner System, this is a reel that is made to overcome a huge range of fishing environments at an affordable price.



BAITRUNNER OC					
Model Number	Power Pro Capacity [lb-yd]	Gear Ratio	Weight [g]	Max Drag [kg]	Bearings
4000OC	15-270, 20-190, 40-145	4.8	380	7.0	3/1
6000OC	30-245, 50-210, 65-130	4.8	545	9.0	3/1
8000OC	40-295, 50-290, 65-180	4.8	590	9.0	3/1
12000OC	50-505,65-310, 80-230	4.4	825	12.0	3/1

# AERO TECHNIUM MGS XSD/XTD

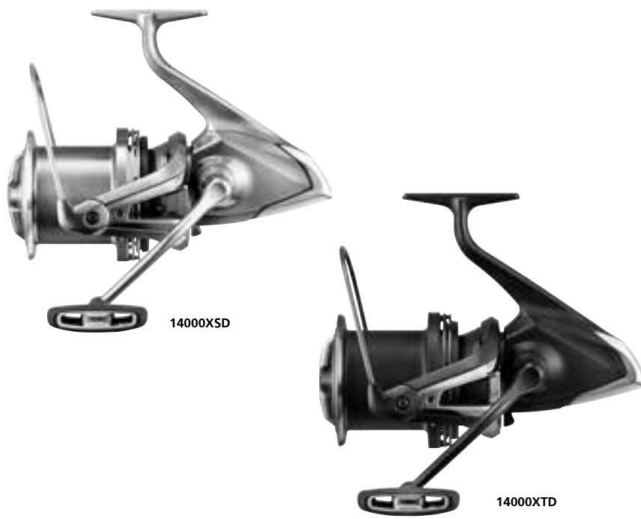

The Aero Technium MgS is widely regarded as the ultimate Big Pit reel.

It is a unique reel of its kind, made up from Shimano newest, ground breaking technology when it comes to aid casting distance. The list of features of this reel is remarkable: every element of Shimano technology available has been used. A Hagane body, Magnesium frame makes it incredibly light yet unbelievably tough. Hagane (cold forged) Gear for maximum strength, Infinity drive and Silent drive for increased winding power, smoothness and durability and a single piece bail arm in titanium to always guide line to the roller and optimum bail arm strength. The most notable feature is a 45mm stoke spool with Super Slow 10 line lay system that lays 107 wraps of line per oscillation to obtain a perfect linear launch, reaching greater distance, more precisely and Rigid cast to be able to handle and better control all of that power exerted during a cast. In one sentence: The best distance reel ever built.



AERO TECHNIUM MGS XSD/ XTD						NEW
Model Number	Nylon Line Capacity [lb-m]	Gear Ratio	Weight [g]	Max Drag [kg]	Bearings	
14000XSD	12-600,16-440,20-330	4.3	510.0	20.0	9/1	
14000XTD	12-600,16-440,20-330	4.3	510.0	20.0	9/1	

# ULTEGRA CI4+ XSC/XTC



The use of CI4+ delivers a substantial weight saving on the compact Ultegra body making reel speed easier to generate when distance casting.

To further increase casting performance the Ultegra uses Super Slow Oscillation line lay and an AR-C spool fitted with Instant Drag for simple, ultra fast adjustment. Cold Forged gears and X-Ship produce powerful winding performance and 5 Stainless A-RB bearings plus a Shimano Roller bearing deliver supreme smoothness.



ULTEGRA CI4+ XSC- XTC						
Model Number	Nylon Line Capacity [lb-m]	Gear Ratio	Weight [g]	Max Drag [kg]	Bearings	
5500XSC	10-425, 12-315, 16-230	5.3	450	15.0	5-1	
14000XSC	50-600, 65-390, 80-315	4.3	545	20.0	5-1	
5500XTC	10-425, 12-315, 16-230	5.3	455	15.0	5-1	
14000XTC	50-600, 65-390, 80-315	4.3	560	20.0	5-1	

# ULTEGRA XSE/XTE



The reel is protected according to Shimano's latest innovation X-Protect which will guarantee to protect the reel's inner parts against intrusion of water and dirt.

The Parallel Body will help the angler to achieve long and accurate cast without unnecessary fatigue throughout the day.

The Ultegra has a very compact body design which contributes to the feel of a compact and lightweight big pit reel.



ULTEGRA XSE/ XTE						NEW
Model Number	Nylon Line Capacity [lb-m]	Gear Ratio	Weight [g]	Max Drag [kg]	Bearings	
14000XSE	12-600,16-440,20-330	4.3	585.0	20.0	4/1	
14000XTE	12-600,16-440,20-330	4.3	585.0	20.0	4/1	

## SpeedMaster 14000 XSC/XTC



14000XSC

14000XTC

SpeedMaster 14000XTC/XSC is a high-performance workhorse reel built for budget-minded surf anglers.

Feature packed with stunning looks, SpeedMaster is equipped with X-Ship technology for improved gear durability and Hi-Speed Drag to put the brakes on big fish. Super Slow Oscillation ensures optimal line lay and maximum casting distance.



SPEEDMASTER 14000 XSC/ XTC					
Model Number	Nylon Line Capacity [lb/m]	Gear Ratio	Weight [g]	Max Drag [kg]	Bearings
14000XSC	12-600,16-440,20-330	4.3	645	20.0	4/1
14000XTC	12-600,16-440,20-330	4.3	645	20.0	4/1

## AERLEX 10000 XSB/XTB



10000XSB

10000XTB

The Aerlex is a tough reel fitted with Instant Drag designed for heavy duty work.

The new cosmetic design and the superb Aero Wrap II line lay with 2 speed Oscillation, combined with the ARC spool produce the excellent casting performance required by both carp and surf anglers. A high torque 4,6:1 retrieve ratio gives the Aerlex the power to deal with heavy loads over rough ground.



SPEEDMASTER 14000 XSC/ XTC					
Model Number	Nylon Line Capacity [lb/m]	Gear Ratio	Weight [g]	Max Drag [kg]	Bearings
14000XTB	12-600,16-440,20-330	4.3	645	20.0	4/1
14000XSB	12-600,16-440,20-330	4.3	645	20.0	4/1

## BeastMaster 10000XB



10000XB

The Beastmaster XB is the renewed version of the Beastmaster XTA/XSA big pit reel.

The 10000 size aluminum spool is more than enough for both anglers who want to fish far out and surf anglers who want to make long casts. The instant drag is smooth and reliable. The reel is painted matte black with grey details: this color is chosen so the reel matches (color wise) with almost every rod in the market and this black colour is appreciated by anglers as well.



SPEEDMASTER 14000 XSC/ XTC					
Model Number	Nylon Line Capacity [lb/m]	Gear Ratio	Weight [g]	Max Drag [kg]	Bearings
10000XB	40-460,50-360,65-280	4.6	705	15.0	1/1

# SPINNING REEL

## MAINTENANCE TIPS



Tighten drag knob and rinse under low pressure tap water in upright position.

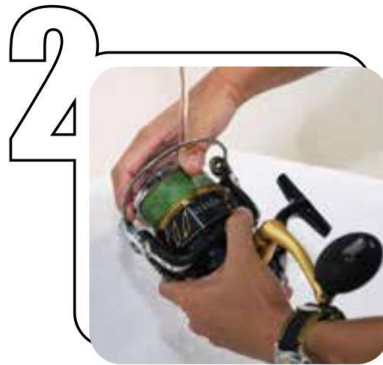

Rotate spool and rinse for 15-20 seconds.

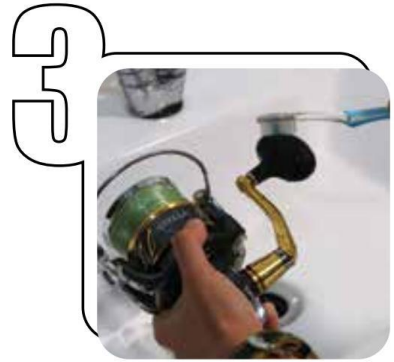

Use a toothbrush to brush handle area, line roller area and drag knob.



Spin reel in fast rotation to channel excess water out.

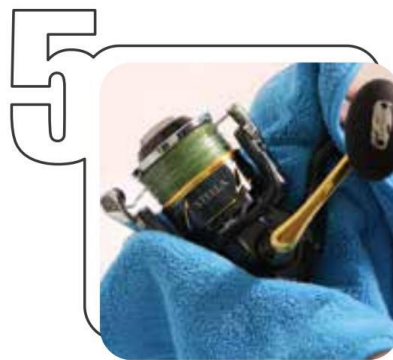

Use a dry cloth to wipe down reel exterior.



Use an air duster to spray difficult access area/joints to clear off excess water.



Remove drag knob and wipe off excessive water on spool and rotor area.

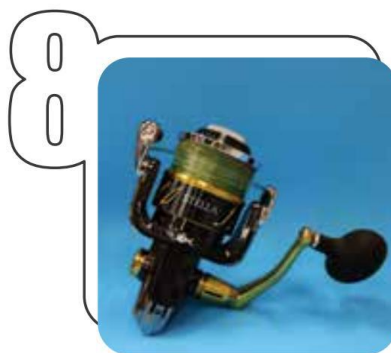

Screw back drag knob and leave it in a cool dry place.

### DOS

- ✓ Remove line after deep sea fishing to wash down spool or if intending to keep for long time storage.
- ✓ Avoid placing your reel on boat side rod holders when boat is traveling to prevent splashes of sea water.
- ✓ Put 1-2 drops of oil on main shaft/ line roller/ handle knob bearings/ drive gear bearings and screws after 2-3 times usage.
- ✓ Send for servicing every six months if the reel is being used frequently.

### DON'TS

- ✗ Rinsing your reel when drag knob is loose.
- ✗ Remove handle when washing.
- ✗ Using high pressure water to wash down your reel.
- ✗ Wash your reel in an upside down position.
- ✗ Soak reel in a bucket of fresh water.
- ✗ Place your reel under direct sunlight after washing.

### Note:

This is a general guide for reel maintenance. For detailed reel maintenance, please refer to the product instruction manual.





## DC BRAKE

**THE DIGITAL CONTROL SYSTEM IS A WATERPROOF, SELF-ENERGIZING SYSTEM WHICH IS COMPUTER CHIP CONTROLLED.**

It recharges with each cast and needs no battery or power source. During the initial moments of the cast, the energy generated by the rotation of the spool is stored in the Digital Control circuit board and powers the Digital Braking System on subsequent casts. During the cast, the Digital Braking system calculates and provides the optimal braking force.

This revolutionary system makes accurate and long distance casting possible, while at the same time minimising tangles, knots and overruns. It anticipates hard casting conditions, like fishing in windy weather or casting very light baits. The DC system produces excellent casting performance for both beginner and tournament anglers.

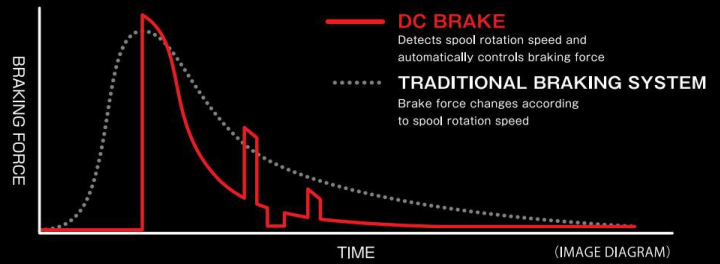

## SVS INFINITY

**SVS INFINITY PROVIDES EASY-TO-MANAGE, CONSISTENT SPOOL CONTROL AND BRAKE FORCE.**

With brake weights that use 'inner friction' against the raceway during the cast, SVS Infinity controls spool speed for precision casting, especially when using lighter lures. The external adjustment knob provides quick, precise adjustments for either the conditions or when you switch lure size.



REEL

SPINNING

SPINNING SW

SPINNING SURF

BAITCAST REELS

BAITCAST SW

SW OVERHEAD

ELECTRIC REELS

YUMEYA



## FTB FINESSE TUNE BRAKE

### FTB IS A BRAKE SYSTEM DEVELOPED ESPECIALLY FOR FINESSE BAITCASTING REELS.

The brake unit is usually located on the side of the spool, but the FTB system is outside the spool reducing weight. By turning the knob on the outside of the reel, magnets are moved deeper or shallower into the spool. Deeper means more braking power, shallower means less braking power. This adjusts itself to the rotational speed of the spool during the cast creating the right amount of braking power.

The FTB system biggest advantage is the ultra light spool. The light weight spool enables long and accurate casts to be made with very light lures. The braking system, with the magnets, is extremely sensitive and can be set very precisely for optimal braking power in every situation.



## MAGNUMLITE SPOOL III

### FOCUSED ON REDUCING THE MOMENT OF INERTIA, THE MAGNUMLITE SPOOL III WITH ULTRA THIN WALLS IS BORN

From the first generation MGL Spool to the second generation MGL spool to the recently reinvented Magnumlite Spool III. The thickness of walls of the spool is minimized without compromising the spool's durability, resulting in a successful reduction in moment of inertia.



Comparison between cross sections of Second-Generation MGL Spool and MGL Spool III. The thickness has been successfully reduced without compromising the durability



## CORESOLID BODY

### A METAL MOLDED BODY THAT COMBINES HIGH RIGIDITY AND COMPACT SIZE

Normally, level wind protector and side plate are made separately from the frame. These are now integrally molded with metal. It boasts high rigidity and achieves a compact body size that makes it easier for paring. A strong body that does not raise a sound even to a strong load achieves a stable winding feeling because it is hard for deflection to occur when fighting with big fish or forcing a fish out of the cover. It is a new body structure with high reliability that can handle power fights with confidence.





**INFINITY DRIVE  
 DRAMATICALLY REDUCED  
 ROTATIONAL RESISTANCE  
 CHALLENGE THE  
 IMPOSSIBLE BY CHANGING  
 THE WAY OF THINKING,  
 INFINITY DRIVE.**

Shimano developed a new mechanism to realize a more powerful and light winding. Of the two grease bearings supporting the pinion gear, the bearing on the spool side has a large rotational resistance. Thus we renewed the structure to be supported from the inside of the pinion gear with the spool shaft. In addition, we reviewed each individual part for improvement to eliminate up to about 60% of the rotational resistance, and also achieve high support rigidity. Without lowering the gear strength, the rotation resistance was greatly reduced.

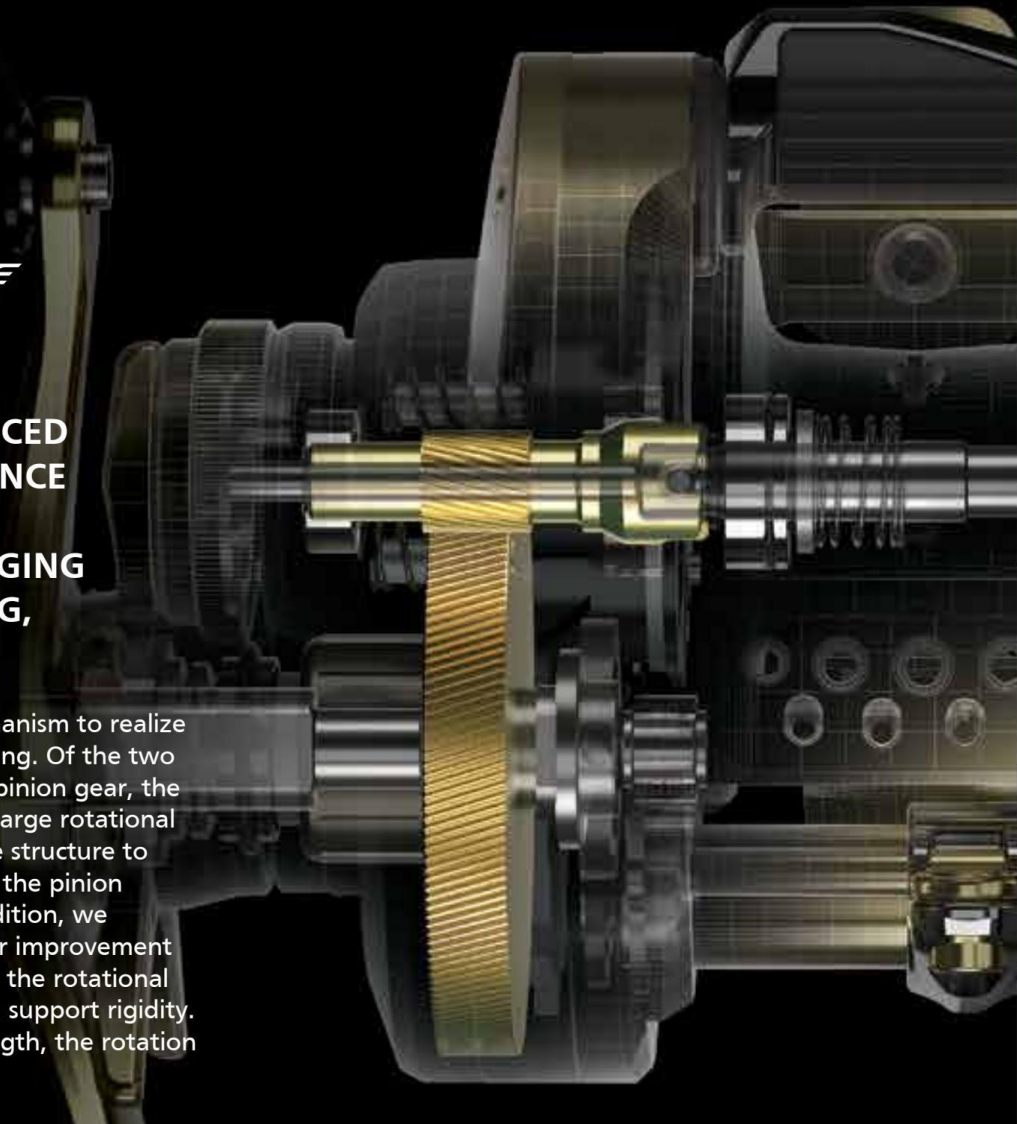

**FALL LEVER  
 CONTROL THE FALL SPEED  
 WITH EASE AND COMFORT  
 WITH THE LATEST LEVER  
 DESIGN!**

What used to be difficult to control [fall speed] has become easy and quick to accurately adjust with the latest lever design. Falling fast in the middle columns or slowing down the fall speed near the bottom, more strategies can be devised for your fishing needs. The lever is also designed to be highly operable as the shape helps control of the fall speed to be smooth and tireless.



REEL

SPINNING

SPINNING SW

SPINNING SURF

BAITCAST REELS

BAITCAST SW

SW OVERHEAD

ELECTRIC REELS

YUMEYA

**4X8DC**



Having added 8 dial settings to the 4 modes of FL (Fluoro), P (PE), NM (Nylon), X (Extreme Long Cast), making more precise brake adjustments a possibility.

**I-DC5**



A broad selection of 3 internal modes and 5 external dial settings. Using 4 polarized magnet rings, a braking system designed to prevent backlashes has been developed to fruition.

**4X8DC MD TUNE**



In addition to F (Fluoro), P (PE) and NM (Nylon) modes, the fourth mode XB, is specialized for dealing with heavy class lures such as metal jigs and big baits. With the 8 dial settings available, it is possible to achieve just the right amount of brake power needed for large shaped lures which are heavily affected by wind resistance.

**I-DC4**



The I-DC4 braking system uses an intelligent Digital Control braking system with an easy to use, 4 setting, externally adjustable brake dial. This will allow anglers to fish a wide variety of lures, in any conditions, with minimal adjustment to the reel.

**4X8DC EXSENCE TUNE**



The latest braking system for targeting seabass with good long distance casts using PE lines. 8 dial settings have been installed to complement the 4 modes comprising of XP (PE line in the direction of wind), P (PE), N (Nylon) and F (Fluoro).

**I-DC4 EXSENCE TUNE**



A brake system suitable for a wide range of weight type sea bass lures by simply adjusting the dial. Dials 1 to 3 are specifically for PE lines while F is for fluoro. The brakes are simple to adjust and can be easily handled by anyone!

**SVS**



From a state of complete stop to a full cast, the rotation of the spool is smooth and easy to control with this centrifugal braking system. Toggle between BRAKE ON or BRAKE OFF with just a flick of the brake collars located in the reel.

**S COMPACT BODY**



By making the palming side of the reel smaller than the handle side, palming is made much more comfortable that is almost gives the impression that the reel is actually one size smaller.

**S3D SPOOL**



Shimano Stable Spool Design (S3D) features a thin and balanced aluminium wall, resulting in significantly reduced spool vibration and creates an incredibly smooth feeling during casting and retrieving.

**LEVEL WIND LINKAGE**



By making the palming side of the reel smaller than the handle side, palming is made much more comfortable that is almost gives the impression that the reel is actually one size smaller.

**SILENT TUNE**

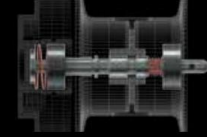

The vibration of the spool is reduced significantly by applying a constant and small amount of pressure on the spool. Smoother spool rotations are more easily kickstarted during casts.

**X-PROTECT**



By combining our water repellent coating and our specially designed water channeling, labyrinth construction, X-PROTECT provides high level water resistance without sacrificing light rear and rotor rotation.

**MGL SPOOL**



The lightweight MGL Spool features reduced spool inertia, for improved casting distance and accuracy with lighter lures. A lighter spool means that it becomes easier to cast lighter lures on thinner lines. The addition of a MGL Spool offers increased versatility across a wider range of lure sizes.

**MICROMODULE GEAR**



MICROMODULE GEAR has two advantages: increased smoothness and better sensitivity. This results accurate performance with improved power transmission.

**LIST OF BAITCAST REEL MODELS**

	ALDEBARAN BFS	ALDEBARAN MGL	METANIUM	BANTAM	ANTARES DC MD
REPRESENTATIVE MODEL					
Product palming dimensions V x Ho x H (mm)	72 x 29 x 37	73 x 28 x 37	69 x 28 x 41	69 x 28 x 41	81 x 33 x 43
Handle knob dimensions L x W x H (mm)	35 x 23 x 14	35 x 23 x 13	39 x 24 x 15	Normal gear +HG 39 x 23 x 16 XG 41 x 26 x 18	42 x 28 x 19

**Palming Dimensions**

Vertical (V)  
Horizontal (Ho)  
Height (H)

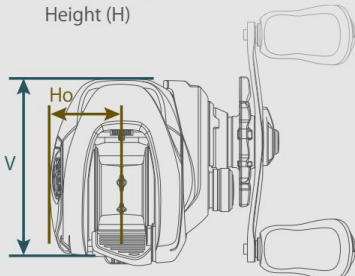

**Handle Knob Dimensions**

Length (L)  
Width (W)  
Height (H)

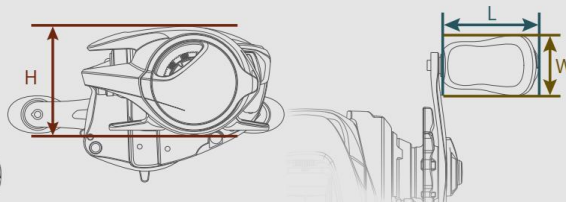

**Gear Ratio**

PG : Power Gear  
HG : High Gear  
MG : Medium Gear  
XG : Extra High Gear

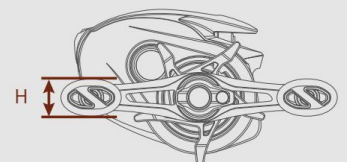

# ANTARES DC



HG RIGHT

An enchanting trajectory of lures flown through the air by our flagship low profile baitcast reel - the Antares.

A condensation of Shimano's latest technologies is the Antares DC, giving you the casting distance you need by incorporating the MGL Spool III onto a DC system (first of its kind!). Coupled with the finetune 4x8 DC brake system, a multiplier effect can be seen when it comes to casting far distances. The S3D spool and Silent Tune eliminates unnecessary vibrations. The Micromodule Gear II, X-Ship and extra bearing on the handle creates a buttery smooth cranking machine in your hands.

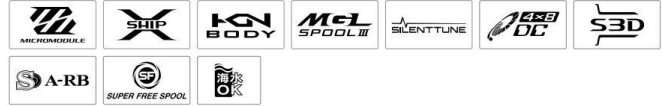

## ANTARES DC

Model Number	Nylon Line Capacity [lb-m]	Gear Ratio	Weight [g]	Max Drag [kg]	Bearings
DC [R]	12-130, 14-110, 16-100, 20-80	5.6	220	5.0	11/1
DC [L]	12-130, 14-110, 16-100, 20-80	5.6	220	5.0	11/1
DC HG [R]	12-130, 14-110, 16-100, 20-80	7.4	220	5.0	11/1
DC HG [L]	12-130, 14-110, 16-100, 20-80	7.4	220	5.0	11/1
DC XG [R]	12-130, 14-110, 16-100, 20-80	7.8	225	5.0	11/1
DC XG [L]	12-130, 14-110, 16-100, 20-80	7.8	225	5.0	11/1

# CALCUTTA CONQUEST DC



100 RIGHT

With the Calcutta Conquest DC, fine adjustments in the brake power of the reel are made possible through the I-DC5 braking system, resulting in a significant improvement in anti-backlash performance.

The countermeasures against effects of strong wind on lures are improved with the new W (Wind) mode. With a low inertia to easily kick-start the rotation of the spool, the Magnumlite Spool offers improved castability of the reel, allowing for long and comfortable casts even at low trajectories. Long cast distances are also easily achievable even when using lures which are heavily affected by wind effects. The rigidity of the cold forged body paired with micromodule gear feature gives a low-noise and comfortable cranking experience.

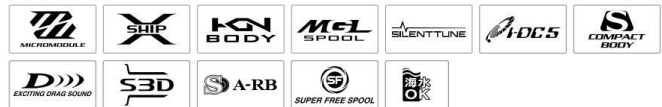

## CALCUTTA CONQUEST DC

Model Number	Nylon Line Capacity [lb-m]	Gear Ratio	Weight [g]	Max Drag [kg]	Bearings
100 [R]	12-100, 14-90, 16-80	5.6	240	4.0	12/1
101 [L]	12-100, 14-90, 16-80	5.6	240	4.0	12/1
100HG [R]	12-100, 14-90, 16-80	6.8	240	4.0	12/1
101HG [L]	12-100, 14-90, 16-80	6.8	240	4.0	12/1
200 [R]	14-145, 16-120, 20-100	4.8	260	6.0	12/1
201 [L]	14-145, 16-120, 20-100	4.8	260	6.0	12/1
200HG [R]	14-145, 16-120, 20-100	6.2	265	6.0	12/1
201HG [L]	14-145, 16-120, 20-100	6.2	265	6.0	12/1

# Metanium DC



XG RIGHT

Metanium DC offers anglers the lightweight and versatile performance of Metanium, now with Shimano's flagship DC braking technology.

Metanium DC comes equipped with our new DC brake system called "I-DC5" "I-DC5" has 2 sets of dial adjustment. With the inside dial, you can select the type of line used. (1. Nylon, 2. Fluorocarbon & 3. PE Line) The outside dial adjustment is based on the lure type. 1. Big Lures (18-30g), 2. Medium Lures (10-20g), 3. Small Lures (8-12g) & 4. Finesse Lures (5-8g) There is also the "AUTO" function, letting the on board DC decide optimal brake setting.



## METANIUM DC

Model Number	Nylon Line Capacity [lb-m]	Gear Ratio	Weight [g]	Max Drag [kg]	Bearings
DC [L]	12-120, 14-100, 16-85, 20-70	6.2	190	5.0	9/1
DC [R]	12-120, 14-100, 16-85, 20-70	6.2	190	5.0	9/1
DC HG [L]	12-120, 14-100, 16-85, 20-70	7.4	190	5.0	9/1
DC HG [R]	12-120, 14-100, 16-85, 20-70	7.4	190	5.0	9/1
DC XG [L]	12-120, 14-100, 16-85, 20-70	8.5	195	5.0	9/1
DC XG [R]	12-120, 14-100, 16-85, 20-70	8.5	195	5.0	9/1

## EXSENCE DC SS



XG RIGHT

Bring yourself closer to the realm of Bait Style in the bass game. The Exsence was developed to do just that!

The special settings within the I-DC4 Exsence Tune are easily adjustable and simple to understand. With modes 1 to 3 tuned specifically for PE lines and mode 4 for Fluoro lines, this brake system allows for long casting distances for a variety of weights and lures of different weights. Advanced technologies such as HAGANE body, Micromodule Gear and X-SHIP will help you achieve greater casting distances!



### EXSENCE DC SS

Model Number	Line Capacity PE [No.-m]	Gear Ratio	Weight [g]	Max Drag [kg]	Bearings
HG [R]	1-365, 1.5-255, 2-180	7.4	220	5.0	6/1
HG [L]	1-365, 1.5-255, 2-180	7.4	220	5.0	6/1
XG [R]	1-365, 1.5-255, 2-180	8.5	225	5.0	6/1
XG [L]	1-365, 1.5-255, 2-180	8.5	225	5.0	6/1

## Scorpion DC



150XG RIGHT

A "free style" reel made for versatility!

Casting long distances? The MGL Spool upgrade has got you covered. Deeper spools mean greater line capacity for various adjustments depending on what you are fishing for. The Micromodule Gear suppresses noise while providing impressionable cranking power. The I-DC5 brake system provides minute changes in brake power which can be adjusted swiftly and tirelessly. The 3 different gear ratios from normal to extra high gears allow for fishing anywhere from bass species to rock fishing!!



### SCORPION DC

Model Number	Nylon Line Capacity [lb-m]	Gear Ratio	Weight [g]	Max Drag [kg]	Bearings
150 [R]	12-130, 14-110, 16-100	6.2	215	5.5	7/1
151 [L]	12-130, 14-110, 16-100	6.2	215	5.5	7/1
150HG [R]	12-130, 14-110, 16-100	7.4	215	5.5	7/1
151HG [L]	12-130, 14-110, 16-100	7.4	215	5.5	7/1
150XG [R]	12-130, 14-110, 16-100	8.5	225	5.5	7/1
151XG [L]	12-130, 14-110, 16-100	8.5	225	5.5	7/1

## SLX DC XT



70XG RIGHT

A technical-versatile reel allowing for quick re-casts and accurate brake adjustments.

In a class of its own, the SLX series is given a spool of low moment of inertia along with a DC system to outperform its preceding models. The MGL Spool III allows for a decent casting distance even with a very light loading on the rod which is perfect for situations such as narrow overhead casts along a low trajectory! The Digital Control (DC) brake system in this lineup is the Calcutta Conquest DC's I-DC5 brake unit, minimizing risks of backlashes and optimizing casting distances. With 3 different gear ratios, this lineup is perfect from lure games to big baits, making it a versatile option for anglers out there!



### SLX DC XT

Model Number	PowerPro Capacity [lb-yd]	Gear Ratio	Weight [g]	Max Drag [kg]	Bearings
70 [R]	20-115,30-105,40-80	6.2	195.0	5.5	7/1
71 [L]	20-115,30-105,40-80	6.2	195.0	5.5	7/1
70HG [R]	20-115,30-105,40-80	7.4	195.0	5.5	7/1
71HG [L]	20-115,30-105,40-80	7.4	195.0	5.5	7/1
70XG [R]	20-115,30-105,40-80	8.1	195.0	5.5	7/1
71XG [L]	20-115,30-105,40-80	8.1	195.0	5.5	7/1

NEW

# SLX DC



70HG RIGHT

Built on the same compact, rigid and versatile platform as the popular SLX baitcasting reel, the addition of Shimano's unique DC Braking technology has won the SLX DC the title of "Best Freshwater Reel" at the ICAST 2019.

SLX DC shows no compromise when it comes to delivering excellent casting performance which is achievable by any angler. The SLX DC offers four adjustable settings that enables anglers to fish a wide variety of lures of different shapes and sizes, in all weather conditions. It also feature Hagane Body which helps to ensure that the reel is extremely rigid and durable, meaning that all movement results in smooth, yet strong cranking power.



SLX DC						
Model Number	PowerPro Capacity [lb-yd]	Gear Ratio	Weight [g]	Max Drag [kg]	Bearings	
70 [R]	20-115, 30-105, 40-80	6.3	210	5.5	6/1	
71 [L]	20-115, 30-105, 40-80	6.3	210	5.5	6/1	
70HG [R]	20-115, 30-105, 40-80	7.2	210	5.5	6/1	
71HG [L]	20-115, 30-105, 40-80	7.2	210	5.5	6/1	
70XG [R]	20-115, 30-105, 40-80	8.2	210	5.0	6/1	
71XG [L]	20-115, 30-105, 40-80	8.2	210	5.0	6/1	
150 [R]	20-150, 30-135, 40-105	6.3	215	5.5	4/1	
150HG [R]	20-150, 30-135, 40-105	7.2	215	5.0	4/1	
150XG [R]	20-150, 30-135, 40-105	8.2	215	5.0	4/1	
151 [L]	20-150, 30-135, 40-105	6.3	215	5.5	4/1	
151HG [L]	20-150, 30-135, 40-105	7.2	215	5.0	4/1	
151XG [L]	20-150, 30-135, 40-105	8.2	215	5.0	4/1	

# CALCUTTA CONQUEST BFS



HG LEFT

Ever felt undergunned when you fish BFS and hook on a big fish? Fret not! Introducing our first round body bait casting reel for Bait Finesse Fishing!

The Calcutta Conquest BFS HG is Shimano's very first round profile BFS reel. It is equipped with Micro Module Gear, X-Ship, HAGANE body and Finesse Tune Brake (FTB) system. The use of Micro Module Gear and HAGANE Body gives the BFS HG a luxurious retrieval experience. All this smoothness is paired with increased power in cranking. The reel weight is reduced through the adoption of our FTB system which uses a specially designed spool featuring weight-saving holes and magnetic braking.



CALCUTTA CONQUEST BFS						
Model Number	Nylon Line Capacity [lb-m]	Gear Ratio	Weight [g]	Max Drag [kg]	Bearings	
BFS HG [R]	8-45	6.8	200	4.0	12/1	
BFS HG [L]	8-45	6.8	200	4.0	12/1	

# ALDEBARAN BFS



XG LEFT

Think slithering light lures on water surfaces. The pinnacle of all bait finesse models, perfect for low trajectory casts!

The Aldebaran BFS is the first baitcast finesse reel to have the MGL spool III incorporated into its design. The low moment of inertia of the spool allows for more precise casts even with a low loading on the rod. The Finesse Tune Brake (FTB) system uses magnets as its operating principle to minimize backlash yet allows for casting distances to be stretched to their maximum automatically. This brake unit is not installed on the spool itself, allowing for a low moment of inertia. The power of the brake unit is adjusted using the dial which controls the surface area of overlap between the magnets and the spool. At its lowest setting, the latest FTB system integrates a small ring to allow for any magnetic force to be absorbed, giving almost zero resistance to the spool for a long cast. On top of the reel's light weight of 130g, the lineup comes with the MicroModule Gear II for smoothness and Exciting Drag Sound to light up the fire in all anglers!



ALDEBARAN BFS						
Model Number	Nylon Line Capacity [lb-m]	Gear Ratio	Weight [g]	Max Drag [kg]	Bearings	
HG [R]	6-45, 8-45	7.8	130	3.5	10/1	
HG [L]	6-45, 8-45	7.8	130	3.5	10/1	
XG [R]	6-45, 8-45	8.9	130	3.5	10/1	
XG [L]	6-45, 8-45	8.9	130	3.5	10/1	

**NEW**

REEL

SPINNING

SPINNING SW

SPINNING SURF

BAITCAST REELS

BAITCAST SW

SW OVERHEAD

ELECTRIC REELS

YUMEYA

## Scorpion BFS



LEFT

## SLX BFS



LEFT

## ALDEBARAN MGL



30HG RIGHT

### Introducing Scorpion reel with bait finesse specifications.

The Scorpion name is increasing in popularity among many anglers and has expanded its range to include bait finesse specifications. FTB (Finesse Tune Brake) allows you to cast a lure comfortably either by overhead casting or pitching. This reel is suitable for SW use. It can be used for saltwater bait finesse games, a rising trend in the surrounding waters. With Exciting Drag Sound, you will enjoy the thrill of the game.



#### SCORPION BFS

Model Number	Nylon Line Capacity [lb-m]	Gear Ratio	Weight [g]	Max Drag [kg]	Bearings
BFS [R]	8-45	6.3	165	3.5	7/1
BFS [L]	8-45	6.3	165	3.5	7/1
BFS XG [R]	8-45	8.2	165	3.5	7/1
BFS XG [L]	8-45	8.2	165	3.5	7/1

### A low cost performance entry reel to the bait finesse realm.

The long awaited for bait finesse model enters the impressionable SLX series of baitcasting reels. The SLX BFS uses the Finesse Tune Brake (FTB) system which helps cast even the lightest of lures with finesse and purpose.

Equipped with the X-Ship bearings and exciting drag sound, the SLX BFS is a high quality reel made with a very intent purpose (ultra light game) for you to enjoy.



#### SLX BFS

Model Number	Nylon Line Capacity [lb-m]	Gear Ratio	Weight [g]	Max Drag [kg]	Bearings
RIGHT	8-45	6.3	170	3.5	5/1
LEFT	8-45	6.3	170	3.5	5/1
XG [R]	8-45	8.2	170	3.5	5/1
XG [L]	8-45	8.2	170	3.5	5/1

### Aldebaran MGL has magnumlite shallow spool which brings lightweight lure fishing to the next level.

This special spool is mounted on Aldebaran dedicated for lightweight lures. Drilled holes on the side of the spool greatly reduces weight and inertia, reducing the braking force required for control. In addition to being able to handle even lighter lures, we also improved the performance of long range casting. Even with the slightest weight will cause instant maximum acceleration the moment you cast.



#### ALDEBARAN MGL

Model Number	Nylon Line Capacity [lb-m]	Gear Ratio	Weight [g]	Max Drag [kg]	Bearings
30 [R]	8-100, 10-90, 12-65	6.5	135	4.5	9/1
31 [L]	8-100, 10-90, 12-65	6.5	135	4.5	9/1
30HG [R]	8-100, 10-90, 12-65	7.4	135	4.5	9/1
31HG [L]	8-100, 10-90, 12-65	7.4	135	4.5	9/1



# Scorpion MGL



150XG RIGHT

Featuring the MGL spool, this reel is able to cast even light lures with great distance and ease.

Casts with low trajectories are comfortably achieved with the Scorpion. Other than a Hagane Body and Micromodule gears, the new SVS Infinity brake system allows for easy setting for the amount of brake anglers need.

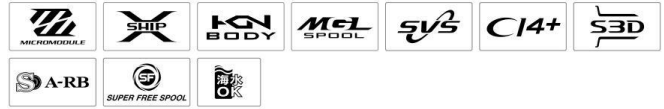

SCORPION MGL						
Model Number	Nylon Line Capacity [lb-m]	Gear Ratio	Weight [g]	Max Drag [kg]	Bearings	
150 (R)	12-130, 14-110, 16-100	6.2	210	5.5	7-1	
151 (L)	12-130, 14-110, 16-100	6.2	210	5.5	7-1	
150HG (R)	12-130, 14-110, 16-100	7.4	210	5.5	7-1	
151HG (L)	12-130, 14-110, 16-100	7.4	210	5.5	7-1	
150XG (R)	12-130, 14-110, 16-100	8.5	215	5.5	7-1	
151XG (L)	12-130, 14-110, 16-100	8.5	215	5.5	7-1	

# CURADO MGL



70HG [R]

**Dependability and Performance.**

Small in hand but large in durability, dependability and performance, the Curado MGL 70 K is a new addition to Shimano's coveted line of Curado low-profile reels. The reel's lightweight MGL Spool requires less start-up energy due to decreased inertia and results in longer casts with reduced effort.

The new Curado MGL 70 K is a great reel choice for anglers pitching and flipping in tight cover when increased line capacity is not required. But anglers shouldn't be concerned about its compact size when fighting fish in close quarters or heavy cover, it is equipped with a Cross Carbon Drag to provide the needed stopping power against large fish. And just like the rest of the Curado family of reels, the versatile Curado MGL 70 K features MicroModule Gear for enhanced smoothness as well as a HAGANE Body for increased rigidity and durability for years of fishing performance.



CURADO MGL						
Model Number	PowerPro Line Capacity [lb-yds]	Gear Ratio	Weight [g]	Max Drag [kg]	Bearings	
70HG [R]	20-115, 30-105, 40-80	7.4	195	5.5	8/1	
71HG [L]	20-115, 30-105, 40-80	7.4	195	5.5	8/1	
70XG [R]	20-115, 30-105, 40-80	8.1	195	5.5	8/1	
71XG [L]	20-115, 30-105, 40-80	8.1	195	5.5	8/1	

# SLX MGL



70 RIGHT

A responsive MGL Spool in a HAGANE body has given birth to the SLX MGL reel with incredibly high castability and outstanding rigidity. The highly performing SLX is clad with specs from high end models.



SLX MGL						
Model Number	Nylon Line Capacity [lb-m]	Gear Ratio	Weight [g]	Max Drag [kg]	Bearings	
70 [R]	12-100, 14-90, 16-80	6.3	190	5.5	4/1	
71 [L]	12-100, 14-90, 16-80	6.3	190	5.5	4/1	
70HG [R]	12-100, 14-90, 16-80	7.2	195	5.5	4/1	
71HG [L]	12-100, 14-90, 16-80	7.2	195	5.5	4/1	
70XG [R]	12-100, 14-90, 16-80	8.2	195	5.5	4/1	
71XG [L]	12-100, 14-90, 16-80	8.2	195	5.5	4/1	

# ANTARES



RIGHT

Silent Spool and S3D Spool, these are the two features on the Antares which eliminates as much as possible the vibration which come with a rotating spool.

Displaying one of the finest responses in a reel with the latest MGL Spool III, technical casts such as pitching and skipping are executed perfectly.



ANTARES					
Model Number	Nylon Line Capacity [lb-m]	Gear Ratio	Weight [g]	Max Drag [kg]	Bearings
RIGHT	12-100, 14-90, 16-80, 20-65	6.2	220	5.0	10/1
LEFT	12-100, 14-90, 16-80, 20-65	6.2	220	5.0	10/1
HG RIGHT	12-100, 14-90, 16-80, 20-65	7.4	220	5.0	10/1
HG LEFT	12-100, 14-90, 16-80, 20-65	7.4	220	5.0	10/1

# Metanium



HG RIGHT

A core solid body combined with a low moment of inertia Magnumlite Spool III.

Strong yet light, bring this reel on you to a myriad of fishing scenes and still be confident that you have a trusty and versatile partner on hand. Being a lightweight and highly operable reel, the revamped Metanium is an all rounder with its Magnesium core solid body. Cast lighter lures to greater distances with the Magnumlite Spool III on every reel in the lineup. Easy to use and with improved adaptability, the lineup brings technicality into the game including light rigs. The toughness does not only lie in the body of the reel, but the drive gear is also powerful enough to win you those tough fights on the water.

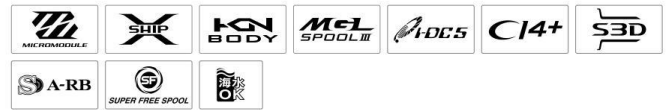

METANIUM					
Model Number	Nylon Line Capacity [lb-m]	Gear Ratio	Weight [g]	Max Drag [kg]	Bearings
RIGHT	12-100, 14-90, 16-80, 20-65	6.2	175	5.0	10/1
LEFT	12-100, 14-90, 16-80, 20-65	6.2	175	5.0	10/1
HG RIGHT	12-100, 14-90, 16-80, 20-65	7.1	175	5.0	10/1
HG LEFT	12-100, 14-90, 16-80, 20-65	7.1	175	5.0	10/1
XG RIGHT	12-100, 14-90, 16-80, 20-65	8.1	175	5.0	10/1
XG LEFT	12-100, 14-90, 16-80, 20-65	8.1	175	5.0	10/1

# Metanium SHALLOW EDITION



XG RIGHT

Perfect for anglers focused on the technicalities of fishing. A light yet prominent shallow spool model.

An unusual spin has been given to Shimano's all rounder flagship model - Metanium. The shallow edition of the Metanium focuses on the technicalities of fishing. Being 10g lighter than the current Metanium, anglers can expect a better operability with this shallow edition when it comes to spot fishing such as texas rigs or rubber lures. In addition to long casting distances, the reel is perfect for situations where multiple short-range casts are executed across a short window of time. If the preceding Metanium models provide a wide range of baitcasting options, this reel is the opposite and allows the true enthusiasts an option to pursue their obsession in the ultra-light game!

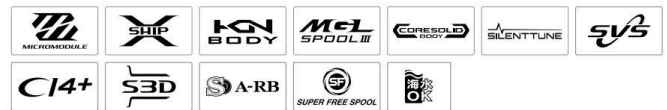

METANIUM SHALLOW EDITION						NEW
Model Number	Nylon Line Capacity [lb-m]	Gear Ratio	Weight [g]	Max Drag [kg]	Bearings	
RIGHT	8-100, 10-90, 12-65	6.2	165	5.0	10/1	
LEFT	8-100, 10-90, 12-65	6.2	165	5.0	10/1	
HG RIGHT	8-100, 10-90, 12-65	7.1	165	5.0	10/1	
HG LEFT	8-100, 10-90, 12-65	7.1	165	5.0	10/1	
XG RIGHT	8-100, 10-90, 12-65	8.1	165	5.0	10/1	
XG LEFT	8-100, 10-90, 12-65	8.1	165	5.0	10/1	

# Bantam



HG RIGHT

A more carefree option which still packs a lot of power.

The latest rendition of Bantam has been given the size 150 MGL III spool, allowing for quick casts with minimal loading yet still achieve the casting distances you need. The freedom in casting techniques and ease of re-casts almost makes the new Bantam feel like the 2019 Antares reel. On top of the compact and highly durable body derived from the Core Solid Body technology, it is the first time the Infinity Drive technology has been integrated in a low profile baitcast model. The technology reduces rotational resistance which translates directly to more cranking/retrieving power for you as the angler. The versatile Bantam reel has just been given a huge upgrade in power, making this lineup one of the strongest versatile lineups in its league.



BANTAM						NEW
Model Number	Nylon Line Capacity [lb-m]	Gear Ratio	Weight [g]	Max Drag [kg]	Bearings	
RIGHT	8-100,10-90,12-65	6.2	165	5.0	8/1	
LEFT	8-100,10-90,12-65	6.2	165	5.0	8/1	
HG RIGHT	8-100,10-90,12-65	7.1	165	5.0	8/1	
HG LEFT	8-100,10-90,12-65	7.1	165	5.0	8/1	
XG RIGHT	8-100,10-90,12-65	8.1	165	5.0	8/1	
XG LEFT	8-100,10-90,12-65	8.1	165	5.0	8/1	

# Scorpion



70HG RIGHT

With extended line capacity and improved durability, it's hard to resist the Scorpion.

Featuring X-Ship and sturdy aluminium frame, the Scorpion is made to tackle any fishing conditions. The SVS brake system is designed to be lightweight, contributing to low inertia startup during casting. Also available in sizes 70 novv.



SCORPION					
Model Number	Nylon Line Capacity [lb-m]	Gear Ratio	Weight [g]	Max Drag [kg]	Bearings
70 [R]	12-100, 14-90, 16-80	6.3	190	4.5	7-1
70HG [R]	12-100, 14-90, 16-80	7.2	190	4.5	7-1
70XG [R]	12-100, 14-90, 16-80	8.2	190	4.5	7-1
71 [L]	12-100, 14-90, 16-80	6.3	190	4.5	7-1
71HG [L]	12-100, 14-90, 16-80	7.2	190	4.5	7-1
71XG [L]	12-100, 14-90, 16-80	8.2	190	4.5	7-1

# CURADO K



300HG RIGHT

Reliability and Durability.

The K series of Curado baitcast reels re-define saltwater durability. To withstand the saltwater environment, they feature a specially plated pinion gear, combined with a breakwater wall and drainage port to provide superior protection from water intrusion and corrosion. The durable Hagane Body houses Shimano's innovative MicroModule gearing, it has X-Ship for smooth rotation, and the SVS Infinity Braking System for enhanced casting performance.

Now available in size 200PG, 201PG, 300HG, and 301HG!



CURADO K					
Model Number	PowerPro Line Capacity [lb-yd]	Gear Ratio	Weight [g]	Max Drag [kg]	Bearings
200 [R]	8-180, 10-155, 14-110	6.2	215	5.0	6/1
201 [L]	8-180, 10-155, 14-110	7.4	215	5.0	6/1
200HG [R]	8-180, 10-155, 14-110	8.5	220	5.0	6/1
201HG [L]	8-180, 10-155, 14-110	6.2	215	5.0	6/1
200XG [R]	8-180, 10-155, 14-110	7.4	215	5.0	6/1
201XG [L]	8-180, 10-155, 14-110	8.5	220	5.0	6/1
200PG [R]	30-190,50-120,65-80	5.0	220	5.5	6/1
201PG [L]	30-190,50-120,65-80	5.0	220	5.5	6/1
300 [R]	40-195, 50-190, 65-125	4.7	295	8.0	5/1
301 [L]	40-195, 50-190, 65-125	4.7	295	8.0	5/1
300HG [R]	40-195, 50-190, 65-125	6.6	295	10.0	5/1
301HG [L]	40-195, 50-190, 65-125	6.6	295	10.0	5/1

REEL

SPINNING

SPINNING SW

SPINNING SURF

BAITCAST REELS

BAITCAST SW

SW OVERHEAD

ELECTRIC REELS

YUMEYA

# SLX XT



150HG

# SLX



150HG

# CAIUS



150HG

# BASS ONE XT



150 RIGHT

The SLX XT offers enhanced casting performance with SVS Infinity braking system for anglers targeting Peacock Bass and Barramundi..

The aluminium Hagane body ensures that the reel is extremely rigid and durable. The main upgrade for the SLX XT comes in the form of the New SVS Infinity breaking system. Anglers will have much greater control using the external dial to adjust the braking system with ease, which allows them cast a wider range of lure styles and weights in varying fishing conditions.



SLX XT					
Model Number	Power Pro Capacity [lb-m]	Gear Ratio	Weight [g]	Max Drag [kg]	Bearings
150 [R]	20-150,30-135,40-105	6.3	205	5.5	4/1
150HG [R]	20-150,30-135,40-105	7.2	205	5.0	4/1
150XG [R]	20-150,30-135,40-105	8.2	205	5.0	4/1
151 [L]	20-150,30-135,40-105	6.3	205	5.5	4/1
151HG [L]	20-150,30-135,40-105	7.2	205	5.0	4/1
151XG [L]	20-150,30-135,40-105	8.2	205	5.0	4/1

The Shimano SLX is the replacement model for the Caenan.

With a significant smaller body (22%), the SLX has a very ergonomic shape and is perfect for palming the reel in your hand, making it very comfortable to fish with whole day long. This Mid-Entry price level reel is a perfect all-round reel which can be used for all kinds of fishing and would be great for an angler first baitcasting reel experience.



SLX					
Model Number	Power Pro Capacity [lb-m]	Gear Ratio	Weight [g]	Max Drag [kg]	Bearings
150 [R]	20-150,30-135,40-105	6.3	195	5.5	3/1
150HG [R]	20-150,30-135,40-105	7.2	195	5.0	3/1
150XG [R]	20-150,30-135,40-105	8.2	195	5.0	3/1
151 [L]	20-150,30-135,40-105	6.3	195	5.5	3/1
151HG [L]	20-150,30-135,40-105	7.2	195	5.0	3/1
151XG [L]	20-150,30-135,40-105	8.2	195	5.0	3/1

The Caius is a compact, versatile, and durable baitcasting reel, designed with lightweight lure casting in mind.

The Super Free Spool improves casting performance and the improved 6-pin VBS (Variable Braking System) keeps backlash to a minimum with all weights and sizes of lures.



CAIUS					
Model Number	Power Pro Capacity [lb-m]	Gear Ratio	Weight [g]	Max Drag [kg]	Bearings
150HG [R]	20-150,30-135,40-105	7.2	195	5.0	3/1
151HG [L]	20-150,30-135,40-105	7.2	195	5.0	3/1

Entry model doesn't have to be basic; our entry baitcast reel just got updated!

We've incorporated the SVS brake system with the BassOne XT giving anglers control over brake settings to the minute level. Line capacity has also been reduced in line with current fishing trends, 200 model is now 150 model. A value for money model highly recommended to any angler!



BASS ONE XT					
Model Number	Nylon Line Capacity [lb-m]	Gear Ratio	Weight [g]	Max Drag [kg]	Bearings
150XT [R]	12-130, 14-110, 16-100	7.2	210	5.0	4/1
151XT [L]	12-130, 14-110, 16-100	7.2	210	5.0	4/1

# ANTARES DC MD



XG RIGHT

Specifications for great speed and strength made with a tough game in mind.

Utilizing the latest XB brake, cast large lures without stress. Specially catering for a strong fight, including big bait fishing, each part is exclusively tuned to take on large fish. The XB brake can be set at 8 different levels, making it possible to cast lures with high air resistance without stress. With a gear ratio of 7.8 and a maximum drag of 6.0kg, this reel is fit to challenge large fishes.



ANTARES DC MD					
Model Number	Line Capacity PE [No.-m]	Gear Ratio	Weight [g]	Max Drag [kg]	Bearings
MD XG [R]	3-130, 4-100, 5-80	7.8	235	6.0	10/1
MD XG [L]	3-130, 4-100, 5-80	7.8	235	6.0	10/1

# Scorpion MD



300XG RIGHT

A combination of both power and precision results in an ultra long lasting reel.

Fit for those who have set eyes on fighting against river monsters with a line stock of up to 160m of 20 lb nylon line on the spool. The spool has been lightened and narrowed to give more stability during line outlay. The SVS brake system has been upgraded from using 6 pins to the current 8 pins on the brake wheel to provide you with even finer adjustments in brake power for optimal casting distances and anti-backlash purposes.



SCORPION MD					
Model Number	Nylon Line Capacity [lb-m]	Gear Ratio	Weight [g]	Max Drag [kg]	Bearings
300XG [R]	16-210, 20-160, 25-135	7.9	320	8.0	7/1
301XG [L]	16-210, 20-160, 25-135	7.9	320	8.0	7/1
300XGLH [R]	16-210, 20-160, 25-135	7.9	315	8.0	7/1
301XGLH [L]	16-210, 20-160, 25-135	7.9	315	8.0	7/1

# CALCUTTA CONQUEST



100HG RIGHT

Overbearing power with Shimano's flagship round profile baitcast reel.

The Calcutta Conquest's highly rigid metal body gives a solid cranking feel. It is the first time the highly regarded Infinity Drive (previously only on SW reels) has been included in a baitcast model.

Upgrade includes more powerful hoisting capabilities with lighter and smoother cranking feel. Palming is also made more comfortable by applying low profiling on the body..



CALCUTTA CONQUEST						NEW
Model Number	Nylon Line Capacity [lb-m]	Gear Ratio	Weight [g]	Max Drag [kg]	Bearings	
100 [R]	12-100, 14-90, 16-80, 20-65	5.6	220	4.5	13/1	
101 [L]	12-100, 14-90, 16-80, 20-65	5.6	220	4.5	13/1	
100HG [R]	12-100, 14-90, 16-80, 20-65	7.4	220	4.0	13/1	
101HG [L]	12-100, 14-90, 16-80, 20-65	7.4	220	4.0	13/1	
200 [R]	12-165, 14-145, 16-120, 20-100	4.8	235	6.0	13/1	
201 [L]	12-165, 14-145, 16-120, 20-100	4.8	235	6.0	13/1	
200HG [R]	12-165, 14-145, 16-120, 20-100	6.5	240	6.0	13/1	
201HG [L]	12-165, 14-145, 16-120, 20-100	6.5	240	6.0	13/1	
200XG [R]	12-165, 14-145, 16-120, 20-100	7.5	235	6.0	13/1	
201XG [L]	12-165, 14-145, 16-120, 20-100	7.5	235	6.0	13/1	
300 [R]	16/210, 20/160, 25/135	6.2	330	6.2	12/1	
301 [L]	16/210, 20/160, 25/135	6.2	330	6.2	12/1	
400 [R]	16/300, 20/235, 25/200	6.2	340	6.2	12/1	
401 [L]	16/300, 20/235, 25/200	6.2	340	6.2	12/1	

## GENPU XT



200PG RIGHT

Genpu XT is specifically developed for a wide variety of light offshore vertical techniques.

The 200PG/201PG model features a 60mm power handle equipped with a C14+ extra-large handle knob, which ensures a solid grip and comfortable reeling from the deep. Although it is a very compact and easy to palm reel, it has a line capacity of 200m of PE2, which allows to fish at considerable depths.



GENPU XT						
Model Number	Line Capacity PE [no.-m]	Gear Ratio	Weight [g]	Max Drag [kg]	Bearings	
150 [R]	1.5-200, 2-150, 3-100	6.3	195	4.5	3/1	
151 [L]	1.5-200, 2-150, 3-100	6.3	195	4.5	3/1	
200PG [R]	1.5-260, 2-200, 3-130	5.5	195	5.0	3/1	
201PG [L]	1.5-260, 2-200, 3-130	5.5	195	5.0	3/1	

## GRAPPLER

### 150HG/151HG



150HG RIGHT

A light jigging reel with a fall lever to expand your fishing horizons.

The Grappler has what it needs to perform mesmerizing fall actions - the Fall Lever & the Level Wind Synchronization. With the standard 78 cm retrieve per crank, mix in different pitch while jigging according to your needs. Whether it is bottom fishing, jigging or in-shore fishing, this reel covers a broad spectrum of the fishing game. .



GRAPPLER 150HG/ 151HG						
Model Number	Line Capacity PE [no.-m]	Gear Ratio	Weight [g]	Max Drag [kg]	Bearings	
150HG [R]	0.8-400, 1-330, 1.5-200	7.8	205	4.0	5/1	
151HG [L]	0.8-400, 1-330, 1.5-200	7.8	205	4.0	5/1	

## GRAPPLER



300HG RIGHT

This series has just been improved with the use of advanced technologies by Shimano.

In addition to the HAGANE body, the Grappler has a X-ship structure and Micromodule gears calling for a more stable and smooth cranking experience even under high loads. Moreover, the 70mm round knob is made of the C14+ material, making it strong yet light. With a line capacity of 250m of PE 3.0 line and a gear ratio of 6.2, this reel is not limited to light jigging and jigging. Slow jigging has also been made possible with the Grappler.



GRAPPLER 150HG/ 151HG						
Model Number	Line Capacity PE [no.-m]	Gear Ratio	Weight [g]	Max Drag [kg]	Bearings	
300HG [R]	2-380, 3-250, 4-190	6.2	325	7.0	5/1	
301HG [L]	2-380, 3-250, 4-190	6.2	325	7.0	5/1	

# BAYGAME



300PG RIGHT

The rigidity stems from the reels' HAGANE bodies. The smooth reeling experience, from the X-ship structure and Micromodule Gear feature, allowing for accurate distinction between a real bite and a miss.

With the advanced centrifugal brakes, feel each cast as the SVS infinity brake system brings your lures soaring through the sky. Using a PE2.0 line rating, the spool is capped at 380m of the line and a handle length of 70mm, the latest additions to the Baygame are powerful models with a maximum drag of 8kg. Superb for deep sea fishing and targeting larger species!



※ 1 : 300PG · 301PG  
※ 2 : 150 · 151 · 150DH · 151DH

BAYGAME					
Model Number	Line Capacity PE [no.-m]	Gear Ratio	Weight [g]	Max Drag [kg]	Bearings
150 [R]	1.5-200, 2-150, 3-100	6.9	220	5.0	4/1
151 [L]	1.5-200, 2-150, 3-100	6.9	220	5.0	4/1
150DH [R]	1.5-200, 2-150, 3-100	6.9	220	5.0	4/1
151DH [L]	1.5-200, 2-150, 3-100	6.9	220	5.0	4/1
300PG [R]	2-380, 3-250, 4-190	4.8	325	8.0	5/1
301PG [L]	2-380, 3-250, 4-190	4.8	325	8.0	5/1

# TRANX



300PG RIGHT

The Tranx is designed as a 'working machine for big fish'.

Whether you are throwing large minnows at mackerels or big rubber frogs into heavy cover for snakehead, this reel can do it all! This is our penultimate large size baitcaster designed for fishing the toughest environment. The Tranx encompasses all our best baitcast technology including Hagane body with Aluminium side plate, X-ship gears.



TRANX <span style="float: right;">NEW</span>					
Model Number	Power Pro Capacity [lb.-m]	Gear Ratio	Weight [g]	Max Drag [kg]	Bearings
150 [R]	20-150,30-135,40-105	6.3	190	5.0	2/1
150HG [R]	20-150,30-135,40-105	7.2	190	5.0	2/1
150XG [R]	20-150,30-135,40-105	8.2	190	5.0	2/1
151HG [L]	20-150,30-135,40-105	7.2	190	5.0	2/1
200A [R]	30-190, 50-120, 65-80	6.2	240	13.0	3/1
200AHG [R]	30-190, 50-120, 65-80	7.2	240	13.0	3/1
200AXG [R]	30-190, 50-120, 65-80	8.5	240	13.0	3/1
201AHG [L]	30-190, 50-120, 65-80	7.2	240	12.0	3/1
300A [R]	12-230, 14-180, 17-150	5.8	330	10.0	5/1
301A [L]	12-230, 14-180, 17-150	5.8	330	10.0	5/1
300AHG [R]	12-230, 14-180, 17-150	7.6	330	8.0	5/1
301AHG [L]	12-230, 14-180, 17-150	7.6	330	8.0	5/1
400A [R]	12-330, 14-260, 20-160	5.8	340	10.0	5/1
401A [L]	12-330, 14-260, 20-160	5.8	340	10.0	5/1
400AHG [R]	12-330, 14-260, 20-160	7.6	340	8.0	5/1
401AHG [L]	12-330, 14-260, 20-160	7.6	340	8.0	5/1

# OCEA CONQUEST CT



300HG RIGHT

The Ocea Conquest CT is the addition of a digital counter and a fall lever onto the Ocea Conquest.

Know exactly the depth of the target zone with the digital counter. Control perfectly the fall action of jigs with the fall lever. Applying the knowledge of science, this reel is definitely one of the top few options for committed anglers looking for the best partner.



OCEA CONQUEST CT					
Model Number	Line Capacity PE [no.-m]	Gear Ratio	Weight [g]	Max Drag [kg]	Bearings
200HG [R]	1-440, 2-200	6.2	340	5.0	10/1
201HG [L]	1-440, 2-200	6.2	340	5.0	10/1
200PG [R]	1-440, 2-200	4.8	330	6.0	12/1
201PG [L]	1-440, 2-200	4.8	330	6.0	12/1
300HG [R]	2-380, 3-240, 4-170	6.2	390	7.0	10/1
301HG [L]	2-380, 3-240, 4-170	6.2	390	7.0	10/1
300PG [R]	2-380, 3-240, 4-170	4.8	390	8.0	10/1
301PG [L]	2-380, 3-240, 4-170	4.8	390	8.0	10/1

# OCEA CONQUEST LIMITED



200HG RIGHT

In addition to the strong, smooth and highly operable offshore reel which is the OCEA Conquest is the latest OCEA Conquest Limited, now with a fall lever.

Regardless of light game or assertive fishing styles, this reel covers it all. With the fall lever made available, anglers now have access to an even wider variety of jig actions at their fingertips. Adding to the aesthetically appealing dark blue body is the cold forged Aluminium handle which is lighter and more durable!



OCEA CONQUEST LIMITED					
Model Number	Line Capacity PE [no.-m]	Gear Ratio	Weight [g]	Max Drag [kg]	Bearings
200HG [R]	1-440, 2-200	6.2	300	5.0	10/1
201HG [L]	1-440, 2-200	6.2	300	5.0	10/1
200PG [R]	1-440, 2-200	4.8	290	6.0	12/1
201PG [L]	1-440, 2-200	4.8	290	6.0	12/1

# OCEA CONQUEST



300PG RIGHT

This reel produces revolutionary new cranking smoothness for the angler.

Equipped with Micromodule gears, the cranking is butter smooth. Finer gearing also means more minute movement can be detected for the perfect lure presentation. S Compact Body for the reel reduces body size and improves the ergonomics of the reel.



OCEA CONQUEST					
Model Number	Line Capacity PE [no.-m]	Gear Ratio	Weight [g]	Max Drag [kg]	Bearings
200PG [R]	1-440, 2-200	4.8	275	6.0	12/1
201PG [L]	1-440, 2-200	4.8	275	6.0	12/1
200HG [R]	1-440, 2-200	6.2	285	5.0	10/1
201HG [L]	1-440, 2-200	6.2	285	5.0	10/1
300PG [R]	2-380, 3-240, 4-170	4.8	340	8.0	10/1
301PG [L]	2-380, 3-240, 4-170	4.8	340	8.0	10/1
300HG [R]	2-380, 3-240, 4-170	6.2	345	7.0	10/1
301HG [L]	2-380, 3-240, 4-170	6.2	345	7.0	10/1



# OCEA JIGGER F CUSTOM



2000NRHG RIGHT

# OCEA JIGGER



1500HG RIGHT

# OCEA JIGGER 4000/4000HG



4000HG RIGHT

Finally, the fall lever has found its way onto the Ocea Jigger! With the latest shape of the fall lever, anglers can now control the lever with higher precision.

Fall action of jigs can be controlled more easily without having to monitor the fall speed, allowing anglers to focus on detecting bites underwater. The handle knob has also been re-designed to be lighter and give a better grip to anglers so as to facilitate mid-deep games. We recommend sizes 1000 and 1500 for mid-deep games and sizes 2000 and 3000 for large games.



## OCEA JIGGER F CUSTOM

Model Number	Line Capacity PE [no.-m]	Gear Ratio	Weight [g]	Max Drag [kg]	Bearings
1000HG [R]	2-300, 2.5-230, 3-200	6.4	430	7.0	8/1
1001HG [L]	2-300, 2.5-230, 3-200	6.4	430	7.0	8/1
1500HG [R]	2-300, 2.5-400, 3-320	6.4	430	7.0	8/1
1501HG [L]	2-300, 2.5-400, 3-320	6.4	430	7.0	8/1
2000NRHG [R]	3-400, 4-300, 5-220	6.2	605	10.0	8/1
2001NRHG [L]	3-400, 4-300, 5-220	6.2	605	10.0	8/1
3000HG [R]	3-670, 4-480, 5-400, 6-330	6.2	630	10.0	8/1

The combination of the Hagane Body and S-Compact Body results in an immensely strong yet lightweight jiggering reel that's easy to hold in just one hand (improved palming performance).

The Infinity Drive and Micromodule Gear II gives the reel buttery smoothness while at the same time, increases its retrieving power. Shimano has decided to help anglers use this reel to its full potential by introducing the XG model where a single crank can get you 132cm of retrieveable line. This means faster and more aggressive styles of fishing can be applied!



## OCEA JIGGER

**NEW**

Model Number	Line Capacity PE [no.-m]	Gear Ratio	Weight [g]	Max Drag [kg]	Bearings
1000HG [R]	2/300, 2.5/230, 3/200	6.4	405	7.0	8/1
1001HG [L]	2/300, 2.5/230, 3/200	6.4	405	7.0	8/1
1500PG [R]	2/500, 2.5/400, 3/320	5.1	405	7.5	8/1
1501PG [L]	2/500, 2.5/400, 3/320	5.1	405	7.5	8/1
1500HG [R]	2/500, 2.5/400, 3/320	6.4	405	7.0	8/1
1501HG [L]	2/500, 2.5/400, 3/320	6.4	405	7.0	8/1
1500XG [R]	2/500, 2.5/400, 3/320	7.3	410	6.0	8/1
1501XG [L]	2/500, 2.5/400, 3/320	7.3	410	6.0	8/1
2000NRPG [R]	3/400, 4/300, 5/220	5.1	595	10.0	8/1
2001NRPG [L]	3/400, 4/300, 5/220	5.1	595	10.0	8/1
2000NRMG [R]	3-400, 4-300, 5-220	5.7	580	10.0	8/1
2001NRMG [L]	3-400, 4-300, 5-220	5.7	580	10.0	8/1
2000NRHG [R]	3/400, 4/300, 5/220	6.2	595	10.0	8/1
2001NRHG [L]	3/400, 4/300, 5/220	6.2	595	10.0	8/1
2000NRXG [R]	3-400, 4-300, 5-220	7.0	580	10.0	8/1
2000NRXG [L]	3-400, 4-300, 5-220	7.0	580	10.0	8/1

An overhead reel for jiggering, bring the latest addition to the OCEA JIGGER series - the size 4000, on your deep sea and off-island expeditions.

In addition to being able to hold up to 1200m long of a PE 3.0 rated line, the outer diameter of the palming side of the reel has been made smaller and this makes the reel much more comfortable to hold. The 4000 size retains the solid construction and winding/cranking performance of the JIGGER series. The drag force can be more precisely adjusted with the large star drag on the reel.



## OCEA JIGGER 4000/ 4000HG

Model Number	Line Capacity PE [no.-m]	Gear Ratio	Weight [g]	Max Drag [kg]	Bearings
4000 [R]	3-1200, 4-900, 5-700, 6-580	4.4	785	18	6/1
4000HG [R]	3-1200, 4-900, 5-700, 6-580	5.1	790	18	6/1

# TORIUM



1500HG RIGHT

The TORIUM models are entry models focused more on cost performance.

The reels in this line adopts the rigid HAGANE body and is very comfortable in the hands with the S-COMPACT body. Feel at ease while jigging with the spool lock and handle return structure on the reels. Consisting of 3 reels, this lineup covers a wide range of situations and will make your fishing trips worth their while.



TORIUM					
Model Number	Line Capacity PE [no.m]	Gear Ratio	Weight [g]	Max Drag [kg]	Bearings
1500HG	2-500, 2.5-400, 3-320	6.3	435	7.0	3/1
2000HG	3-400, 4-300, 5-220	6.2	555	11.0	3/1
2000PG	3-400, 4-300, 5-220	4.6	550	15.0	3/1

# TORIUM



30HGA



14HGA

Packed with features like Super Stopper, Cross Carbon Drag, A-RB(Anti-Rust Bearings) and High Efficiency Gearing (HEG),the Torium has it where it counts.



TORIUM					
Model Number	PowerPro Line Capacity [lb/yl]	Gear Ratio	Weight [g]	Max Drag [kg]	Bearings
14HGA [R]	14-300, 16-270, 20-200	6.3	425	15.0	3/1
16HGA [R]	50-530, 65-330, 80-250	6.2	535	11.0	3/1
20HGA [R]	50-710, 65-375, 80-310	6.2	545	11.0	3/1
30HGA [R]	50-1015, 65-515, 80-415	6.2	560	11.0	3/1
16HGA [L]	50-530, 65-330, 80-250	6.2	535	11.0	3/1
20HGA [L]	50-710, 65-375, 80-310	6.2	545	11.0	3/1
30HGA [L]	50-1015, 65-515, 80-415	6.2	560	11.0	3/1

# TEKOTA



800PG

The Tekota is a small sized SW boat fishing and/or light trolling reel. It describes itself best as 'a workhorse'. The reel has a level wind system which is easy for the angler to get the line spooled well on the spool.



TEKOTA						NEW
Model Number	PowerPro Line Capacity [lb/yl]	Gear Ratio	Weight [g]	Max Drag [kg]	Bearings	
300HGLC [R]	30-290, 40-230, 50-190	6.6	340	9.0	3/1	
301HGLC [L]	30-290, 40-230, 50-190	6.6	340	9.0	3/1	
400HGLC [R]	40-320, 50-270, 65-195	6.6	385	9.0	3/1	
401HGLC [L]	40-320, 50-270, 65-195	6.6	385	9.0	3/1	
500HG [R]	40-390, 50-330, 65-240	6.3	440	11.0	3/1	
501HG [L]	40-390, 50-330, 65-240	6.3	440	11.0	3/1	
600HG [R]	40-540, 50-460, 65-330	6.3	465	11.0	3/1	
601HG [L]	40-540, 50-460, 65-330	6.3	465	11.0	3/1	
500HGLC [R]	40-390, 50-330, 65-240	6.3	465	11.0	3/1	
501HGLC [L]	40-390, 50-330, 65-240	6.3	465	11.0	3/1	
600HGLC [R]	40-540, 50-460, 65-330	6.3	485	11.0	3/1	
601HGLC [L]	40-540, 50-460, 65-330	6.3	485	11.0	3/1	
800PG [R]	50-1250, 65-920, 80-750	3.9	840	16.0	4/1	
800PGLC [R]	50-1250, 65-920, 80-750	3.9	870	16.0	4/1	

# SpeedMaster LD II



20 II

With a high maximum drag power and a smooth, ultra-wide range of drag adjustability is the SpeedMaster II.

Its rigid HAGANE Body prevents misalignment of moving parts under the heaviest loads. Plus, a spare drag cam is included for optimal use with mono-filament lines. .



SPEEDMASTER LD II					
Model Number	PowerPro Line Capacity [lb-yd]	Gear Ratio	Weight [g]	Max Drag [kg]	Bearings
12 II	50-700	5.7/3.1	740	18.0	4/0
16 II	50-845	5.7/3.1	760	18.0	4/0
20 II	66-725	5.2/2.3	980	20.0	4/0
25 II	65-900	5.2/2.3	1025	20.0	4/0

# TALICA



20 II

Based upon a narrow body principle which equals less weight, smaller dimensions and easier handling than equivalent lever drag multipliers, Talica is truly a high-speed dream machine.



TALICA					
Model Number	PowerPro Line Capacity [lb-yd]	Gear Ratio	Weight [g]	Max Drag [kg]	Bearings
8 II	40-395, 50-390, 65-235	6.2/4.1	970	7.0	6/0
10 II	40-540, 50-534, 65-335	6.2/4.1	1060	9.0	6/0
12 II	50-700, 65-400, 80-355	6.2/4.1	1410	9.0	6/0
16 II	50-845, 65-485, 80-430	6.2/4.1	1485	12.0	6/0
20 II	65-725, 80-575, 100-435	5.2/2.3	920	20.0	6/0
25 II	65-1000, 80-730, 100-470	5.2/2.3	950	20.0	6/0
50 II	80-1120, 100-945, 150-825	6.2/4.1	1570	27.0	6/0
8	40-395, 50-390, 65-235	6.2	451	7.0	6/0
10	40-540, 50-534, 65-335	6.2	465	9.0	6/0
12	50-700, 65-400, 80-355	5.7	669	9.0	6/0
16	50-845, 65-485, 80-430	5.7	669	12.0	6/0

# TIAGRA

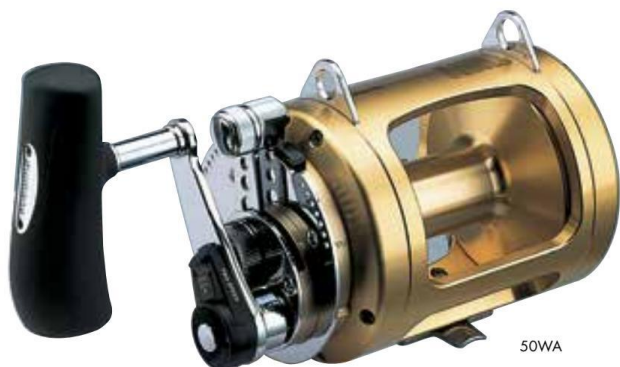

50WA

The big game reel that became a worldwide market leader has too many features to explain in a catalogue! It's the solid construction, in combination with easy to use features, that is loved by the most demanding big game fishermen.



TIAGRA					
Model Number	PowerPro Line Capacity [lb-yd]	Gear Ratio	Weight [g]	Max Drag [kg]	Bearings
12	40-795, 50-790, 65-460	3.9/1.7	970	15.0	6/0
16	50-1210, 65-680, 80-520	3.9/1.7	1060	13.0	6/0
20A	50-1225, 65-720, 80-525	3.9/1.7	1410	16.0	4/0
30A	50-1805, 65-1065, 80-770	3.9/1.7	1485	15.0	4/0
50A	65-1435, 80-1180, 100-865	3.9/1.7	1575	15.0	4/0
50WA	80-1575, 100-1235, 150-1180	3.1/1.3	2445	20.0	4/0
80WA	100-2445, 150-2365, 200-1920	2.5/1.3	3265	20.0	4/0
130A	150-3315, 200-2770, 250-1955	2.1/1.15	4935	40.0	6/0

# DIGITAL CONTROL FOR BAITCAST REELS

Avoid backlash with **Digital Control** in baitcast reels when fishing with medium-heavy (above 16g) lures!

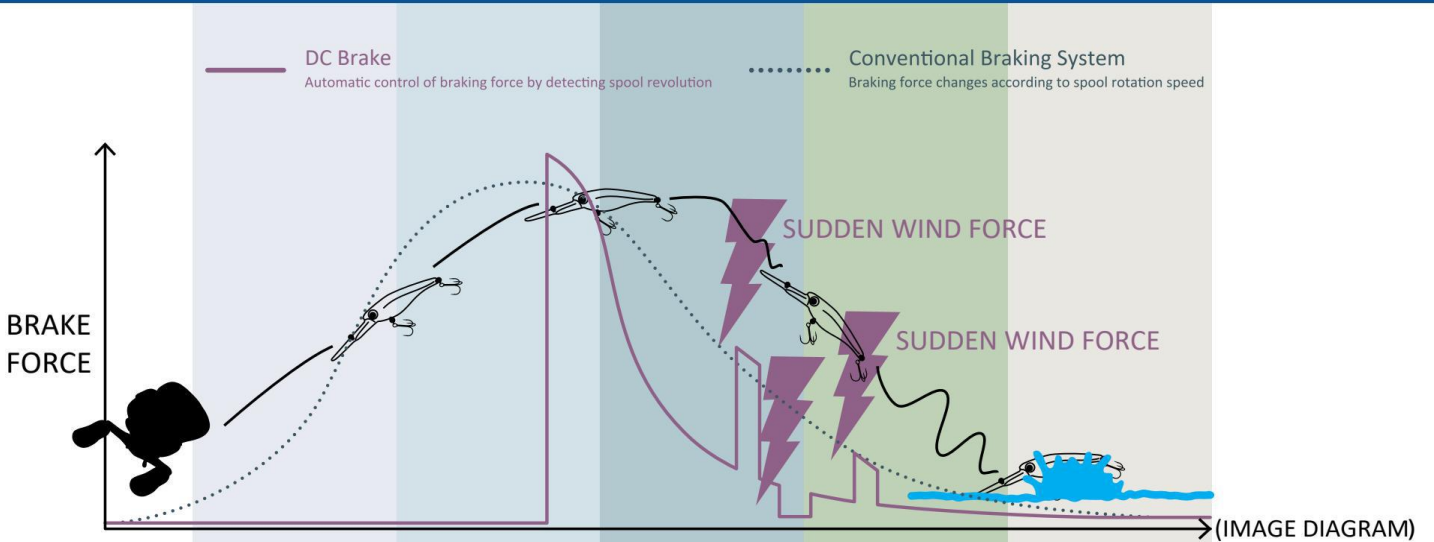

ACTION	CASTING THE LURE	SPOOL ACCELERATION	ENERGY LOSS IN LURE	LURE SLOWS DOWN	LANDING IN WATER
	<p><b>KEY POINT: MINIMUM BRAKING</b></p> <p>During this time, spool needs acceleration without any brake force for further casting distance.</p> <p><b>Digital Control:</b> Minimum brake force for maximum acceleration.</p> <p><b>Centrifugal/Magnetic:</b> Brake force increases as spool acceleration increases.</p>		<p><b>HIGH CHANCE OF BACKLASH!</b></p> <p>Very high chance for backlash due to sudden changes in wind.</p> <p><b>Digital Control:</b> Intermittent braking to compensate for wind force effect.</p> <p><b>Centrifugal/Magnetic:</b> Brake force does not change with wind, high chance for backlash.</p>		<p><b>SAFE LANDING</b></p> <p>Lure accurately lands in target spot, thumb to stop backlash.</p>

DC system applies the optimum braking for medium-heavy (above 16g) lure fishing by letting the current flow through the coil only when the brake is required from the beginning of casting to the lure landing in water.



# BAITCAST/ OVERHEAD

## MAINTENANCE TIPS



Tighten cast control cap and star drag before washing



Rinse reel under low pressure water



Rotate spool and rinse for 15-20 seconds

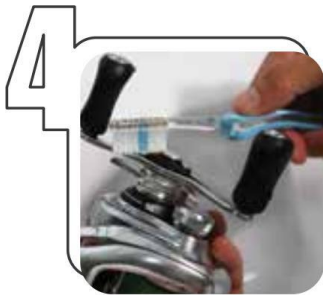

Use a toothbrush to brush handle and star drag area

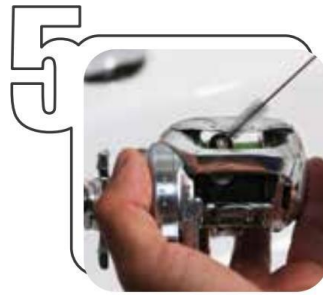

Use a tube brush to brush reel seat and line guide to ensure salt removal



Spin the reel in fast rotation to channel excess water out



Use a dry cloth to wipe the exterior of the reel.



Remove the side cover and wipe off excessive water droplets.



Loosen star drag and leave it in dry and cool place.

### DOS

- ✓ Remove line after deep sea fishing to wash down spool or if intending to keep for long time storage.
- ✓ Avoid placing your reel on boat side rod holders when boat is traveling to prevent splashes of sea water.
- ✓ Put 1-2 drops of oil on main shaft/ line roller/ handle knob bearings/ drive gear bearings and screws after 2-3 times usage.
- ✓ Send for servicing every six months if the reel is being used frequently.

### DON'TS

- ✗ Loosen cast control and star drag before washing as water might penetrate into the body
- ✗ Rinse overhead/ baitcast reel on high pressure water.
- ✗ Dipping/ soaking your reel in fresh water
- ✗ Place directly under sunlight after washing.
- ✗ Wash your reel in upside down position.

### Note:

This is a general guide for reel maintenance. For detailed reel maintenance, please refer to the product instruction manual.

# GIGAMAX MOTOR

AMAZING PERFORMANCE,  
EVEN A RISE IN TEMPERATURE  
CANNOT SLOW IT DOWN!



## GIGAMAX

GIGAMAX MOTOR is a brush-less DC Motor. Shimano is the only company that adopts this brush-less motor in electric reels for our BeastMaster series. Inside the motor, there is a special strong magnet that can maintain its performance level even at high temperatures. The motor is specially tuned to meet the reel's specific performance target.

# MUTEKI MOTOR +

IMMEDIATE  
RESPONSE AT  
ITS CORE

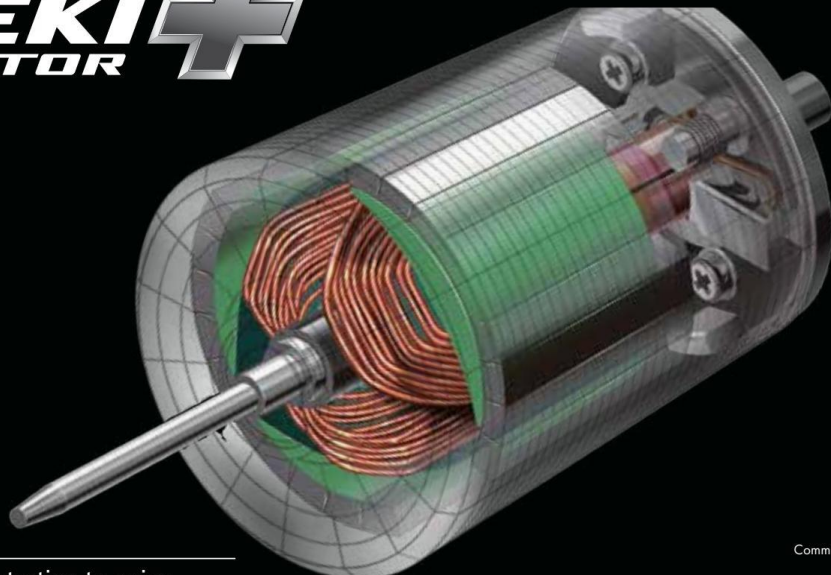

## MUTEKI MOTOR

Increasing number of anglers are starting to enjoy light style boat fishing. Understanding this trend, we designed our electric reels to be more compact. While the body size of the reel is smaller, the power and toughness of the reel has improved. By adopting high quality electronic magnets in our MUTEKI MOTOR +, we improve performance of the motor at high temperatures. The torque of the motor is consistent throughout the operation. MUTEKI MOTOR + can be found in the Forcemaster 800 to 3000 size.

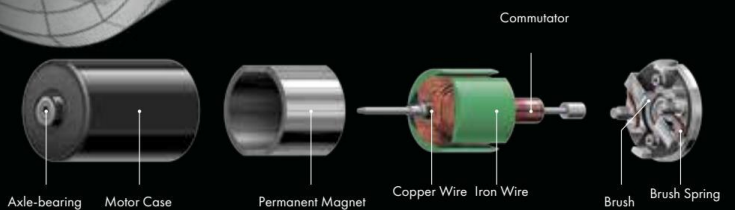



# EVOLVED OPERABILITY TOUCH DRIVE

**ONE-TOUCH  
TO THE TARGET SPEED**



**ONE-HAND  
OPERABILITY**

## WITH ONE TOUCH SPEED CONTROL

A seesaw button configuration installed on the reel allows for quick and precise changes in reeling speed. The speed is adjustable at every stop through a simple press on the buttons. Press the [UP] button to increase the speed by one stop and the [DOWN] button to decrease the speed by one stop.

## ONE-HANDED OPERABILITY

You can control it at will with just the thumb of the hand holding the rod.

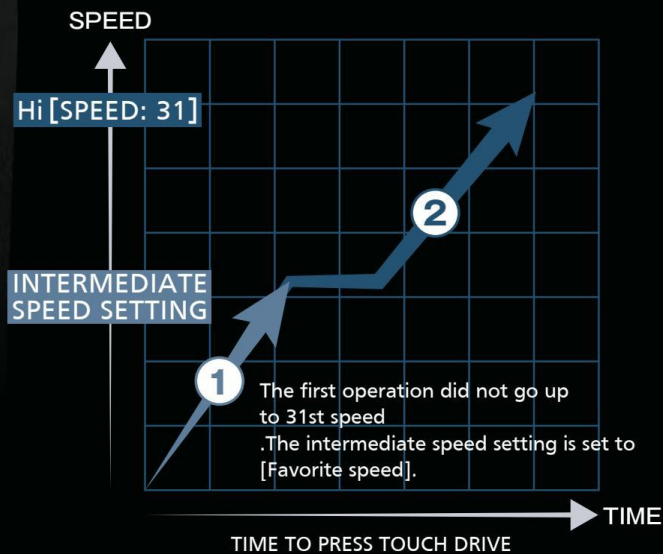

- REEL
- SPINNING
- SPINNING SW
- SPINNING SURF
- BAITCAST REELS
- BAITCAST SW
- SW OVERHEAD
- ELECTRIC REELS
- YUMEYA



# ELECTRIC JIGGING

This EJ system BeastMaster EJ Series. In Manual Mode, the motor is engaged only when the [PICK UP] button is pressed. Anglers can also perform numerous combos of jigging styles with different pitches and rod-jerking motions. On the other hand, have absolute control over the pitch and jigging speed when in Auto Mode. SPEED (motor speed), MOVE (duration of motor being engaged), STOP (duration of motor being disengaged) are the new settings the EJ Auto Mode offers to its controller. Set how fast and how long you want the motor to run for and control seamlessly the amount of time you want the motor to stop. The versatility and convenience of this system allows anglers to perform jigging actions using only one arm!



## ELECTRIC JIGGING MODEL COMPABILITY

### ① HIGHLY DURABLE

FOR TOUGH JIGGING

#### GIGA-MAX MOTOR + REINFORCED GEAR SYSTEM

\*BRUSHLESS STRUCTURE

GIGA-MAX MOTOR with a brushless structure that has no parts in contact with the motor shaft, which is also used in racing cars and Shinkansen. The synergistic effect of the motor with this dramatically improved durability and the reinforced gear system eliminates the negative image of conventional electric jigging. Trouble caused by poor durability is a thing of the past.

### ② GOOD JIG OPERABILITY

LINE SLACK FOR A WIDER COMBINATION OF JIGGING COMBINATIONS

#### LOW INERTIA BRUSHLESS STRUCTURE MOTOR

Momentary pool stop in jerk, which was not possible with conventional electric reels. This is achieved by a brushless motor. Since the inertial force is small, it is possible to stop the motor immediately after the electric power is turned off. You can produce a variety of slides and falls that take advantage of line slack.

Contents of the motor with brushless structure (permanent magnet)



Contents of motor with brush (coil)



### ③ THERE IS A DEDICATED PROGRAM (EJ MODE).

REPRODUCE JIG ACTIONS IN VARIOUS SITUATIONS **3 EJ MODES**

There is a dedicated program (manual jerk mode, auto jerk mode, advanced mode) so that you can enjoy electric jigging more deeply. It is possible to develop an electric jigging game according to various situations, and in the advanced mode installed in the Beast Master 3000EJ, it is now possible to control the strength of the instantaneous force to operate the jig. In advanced mode, you can enjoy a jigging game that is closer to the feeling of a hand-wound reel.

## EJ Mode

### Manual Jerk Mode

A mode in which electric winding is possible while the PICKUP button is pressed. By combining rod action that matches the winding time and timing, it is possible to produce various effects such as regular one-pitch jerk, combination jerk, and long fall.



Line length  
Winding speed of technical lever and Touch Drive  
PICK UP winding speed

### Auto Jerk Mode

SPEED (winding speed), MOVE (winding time). A mode in which you can freely set the STOP (stop time) as you like.

### Advanced Mode

SPEED (winding speed), MOVE (winding time), ACC. (Jerk strength) A mode that can be set freely as you like.

#### One Pitch Jerk

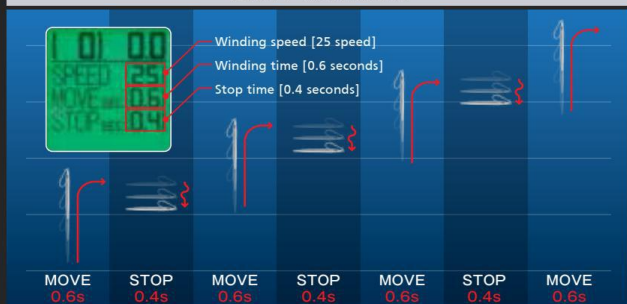

#### Increased Freedom of Jig Action!

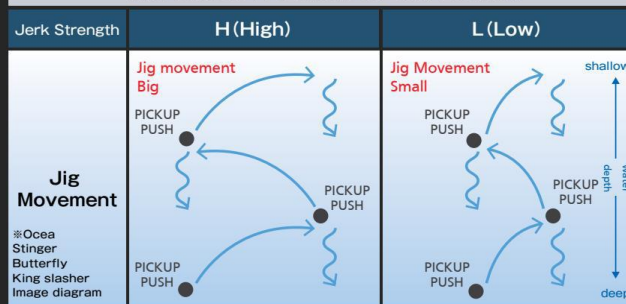



## MUTEKI MOTOR +

Highly responsive during operations, the MUTEKI MOTOR+ is a brush motor which displays high levels of torque and power by using a special magnet made from a rare earth.



## FIRE MACH SYSTEM

In order to provide a smooth switch to reverse rotations, numerous S-ARB (ball bearings) are used to support the main axis of the motor. Similar to the effects of Super Free Spool on smaller sized electric reels, it only requires a small force to slow the spool down from a high rotating speed.



## SPEED CLUTCH

Toggle the clutch between ON and OFF with just a simple press on the clutch lever. The lever can also be toggled while thumbing the spool. This helps to prevent troublesome backlash experiences on the reel. Have full confidence that the jig is in the target column as the clutch lever can still be toggled while the spool is being pressed down.



## S COMPACT BODY

In addition to making electric reels more compact, the cable connector port is moved to the same side of the handle. This structure helps in providing extra comfort when holding the setup in the palms.



## RAKU RAKU MODE/ CONSTANT SPEED MODE

In Raku Raku mode, the reel automatically adjusts the line tension according to the load on the other end. In speed mode, the reel maintains the same reeling speed regardless of the change in load on the other end of the line. This mode is suitable for times when power is desired.



## THERMO ADJUST DRAG

A control function to suppress abnormal heat generation in the drag section to maintain stable drag performance. There are instances when the drag slips immediately after the motor is turned on and this gives off additional unnecessary heat. When the drag slips, rotation speed of motor is automatically lowered to prevent this additional heat from being generated.



## E-EXCITING DRAG SOUND

Digitalizing the exciting drag sound, this feature instills excitement in the angler when fighting fish.



## PRACTICAL POWER

Shimano uses a standard method to measure the actual lifting power of all our electric reels. This metric measures the largest load the electric reel is able to lift up from a water depth of 100 meters. This is important as the test includes factors such as the water pressure and the underwater sea currents. This allows you as an angler to trust in your reel even if the fish on the other end of the line is larger than you expected! Although it is very hard to put a number on how powerful an electric reel is, our developers at Shimano have come up with a complex equation to work out the numbers based on the methodology mentioned above, to provide anglers with the most accurate information we possibly can.

## THE CONVENIENCE OF ELECTRIC JIGGING

### Motor & clutch interlocking function

If the clutch is turned off while the motor is electrically hoisting, the motor will automatically turn off and the motor noise during the fall will disappear. Also, when the clutch is turned on, the electric winding will start again.

### Ultra fine shift control

Of the 31 speed shifts, the 15th speed (intermediate speed) is about half the speed of the conventional speed, making it possible to make finer adjustments.

### Electric constant speed winding control

Normally, the speed changes depending on the bobbin diameter, but it is not affected by the bobbin winding amount and enables perfect constant speed winding by electric power.

\* It works only when the ultra-fine shift control is ON.

### Handle speed display

It is a function to display the speed when winding with the handle on the digital counter. Since it is linked with the 31-step dial that drives the motor, the winding speed by manual winding can be accurately reproduced electrically.

\* It works only when the ultra-fine shift control is ON.



## REEL SIZE COMPARISON

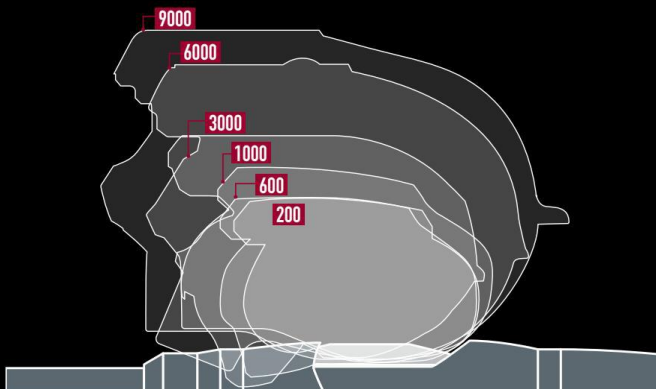

## LINEUP BY MOTOR POWER & SERIES

SERIES	SIZE	SMALL (~600)	MEDIUM (1000~3000)	BIG (4000~)
	SERIES			
BeastMaster				
ForceMaster				
PLAYS				

REEL

SPINNING

SPINNING SW

SPINNING SURF

BAITCAST REELS

BAITCAST SW

SW OVERHEAD

ELECTRIC REELS

YUMEYA

## BeastMaster MD 3000



The torque from the NEW GIGA-MAX motor has been upped 40%! The overwhelming motor power and speed makes the reel a true Monster Drive (MD).

Shimano has successfully incorporated both the power of the BeastMaster 3000XP and the speed of the BeastMaster 3000XS in the latest BeastMaster MD3000, giving it a maximum drag force of 25kg. With the HAGANE body and the upgraded gear system, this electric reel has reached new heights. In addition to the liquid crystal screen making for better visibility during both day and night, the S Compact Body makes palming the reel a more comfortable experience and the large mechanical knob allows for falling action plays underwater.

\*Comes with English and Chinese menu.



BEASTMASTER MD 3000							
Model Number	Line Capacity PE [no.-m]	Gear Ratio	Weight [g]	Max Drag [kg]	Practical Power (kg)	Speed [m/min]	Bearings
3000MD	6-300	4.6	1090	25.0	14	215	15/1

## BeastMaster EJ 3000



It's closer to the feeling of hand-wound jigging, the strongest electric jigging compatible model in Shimano history.

Shimano's strongest electric jigging to date. Shimano believes in the realm of e-jigging, that there are some fish that can only be caught with this technique. No more compromises in power or speed, the BeastMaster EJ series provides both in amplitudes and now the long-awaited size 3000 makes it to the scene. With the NEW EJ mode (advance mode), you can now control even the strength of each jerking motion. This new mode was developed to make e-jigging feel as close to traditional jigging so as to retain the excitement! This reel comes with a reinforced gear system twice\* as durable and a GIGA-MAX MOTOR that is able to achieve an additional 15%\* maximum hoisting speed. Bluefin tuna, Yellowfin, Amberjacks and even squids are all within the range of this machine!

\* 1: 16 Beast Master 3000XP comparison

\*Comes with English and Chinese menu.



BEASTMASTER EJ 3000								NEW
Model Number	Line Capacity PE [no.-m]	Gear Ratio	Weight [g]	Max Drag [kg]	Practical Power (kg)	Speed [m/min]	Bearings	
3000EJ	4-450, 5-350, 6-300, 8-200	3.9	810	20.0	13	195	10/1	

## BeastMaster EJ 2000



Following Spinning and Baitcasting models comes a third option in the jigging field. With the addition of the BeastMaster 2000EJ, Shimano provides all jigging options to anglers especially E-jigging.

EJ mode helps anglers achieve jerking speeds which can never be achieved by the human hands and allows for control in slide and fall actions of jigs. By stopping the spool at the same time the cranking stops, the brushless GIGA-MAX motor allows anglers to control the line slack freely during jigging motions. The GIGA-MAX motor on the BeastMaster 2000EJ is twice as durable as the 18 BeastMaster 2000 with the strengthened gear system in the reel.

\*Comes with English and Chinese menu.



BEASTMASTER EJ 2000							
Model Number	Line Capacity PE [no.-m]	Gear Ratio	Weight [g]	Max Drag [kg]	Practical Power (kg)	Speed [m/min]	Bearings
2000EJ	3-500, 4-400, 5-300	5.1	690	15.0	9.5	215	14/1

## BeastMaster EJ 1000



## BeastMaster 2000



## BeastMaster 3000XP/3000XS



Providing anglers with the highest levels of comfort with both the NEW TouchDrive and SpeedClutch features. A light and subtle yet powerful beast made for e-jigging with the all new EJ mode.

Presenting to all anglers the availability of the EJ mode on the smallest size in the BeastMaster electric reel series - 1000. The reel exhibits high motor speeds and power while keeping a compact and hold-easy body because of the GIGA-MAX motor. With a maximum drag of 15kg and a strength-inclined gear system, this small electric reel is able to conquer even the larger fish species and the durability to execute perfectly trip after trip. Making its first appearance in the BeastMaster series, the NEW TouchDrive enables for swift and accurate control on the motor speed. Though the BeastMaster 1000EJ has an arsenal of features made for e-jigging, this reel is suitable for a variety of Salt Water games thanks to its operability and compact size.

\* Comes with English and Chinese menu.



BEASTMASTER EJ 1000							
Model Number	Line Capacity PE [no.-m]	Gear Ratio	Weight [g]	Max Drag [kg]	Practical Power (kg)	Speed [m/min]	Bearings
1000EJ	3-400, 4-300, 5-230	5.3	700	15.0	9.5	215	14/1

The Beastmaster 2000 is equipped with the GIGA-MAX MOTOR boasting high level power and durability.

The motor and clutch interlocking function and the ultra-fine shift control, this is a high performance model that adds power to the cool and compact reel. Bringing handheld electric games to the next level, any fish at mid depth becomes a target. Power hidden in a compact a lightweight body.

\* Comes with English menu.



BEASTMASTER 2000							
Model Number	Line Capacity PE [no.-m]	Gear Ratio	Weight [g]	Max Drag [kg]	Practical Power (kg)	Speed [m/min]	Bearings
2000	3-500, 4-400, 5-300	5.1	690	15.0	9.5	215	11/1

Shimano is always pushing for more innovation in electric reels.

Previously, 3000 size used to be standard size before but nowadays anglers are eager for big motor power in this size. We improved GIGA-MAX motor and transfer the additional power to Power side or Speed side. 3000XP is Power model. 3000XS is Speed model. Even the retrieve power of Speed model is stronger than previous model. Depending on the target fish, you can choose either the Power model or Speed model. In addition to that, the number of drag stack increased from 3 set to 4 set and achieved 20Kg drag power! We also equipped "Fire Mach System" which contribute smooth spool revolution and "Heat Free System II" which release heat to out side so as to maintain reel performance over prolonged fight.



BEASTMASTER 3000XP/ 3000XS							
Model Number	Line Capacity PE [no.-m]	Gear Ratio	Weight [g]	Max Drag [kg]	Practical Power (kg)	Speed [m/min]	Bearings
3000XP	4-400, 5-350, 6-300, 8-200	3.9	845	20.0	13	170	9/1
3000XS	4-400, 5-350, 6-300, 8-200	3.9	845	20.0	10	215	9/1

# BeastMaster 6000/9000

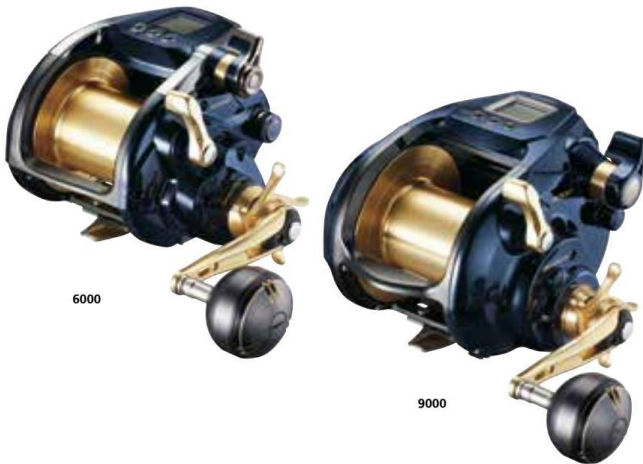

6000

9000

# ForceMaster 200/201/201DH



200 RIGHT

# ForceMaster 600/600DH/601/601DH



600 RIGHT

The three most important aspects to an electric reel - durability, power and the reel's ability to channel excessive heat to the surroundings.

These three criteria have been further evolved on the BeastMaster 6000 and BeastMaster 9000, giving birth to an indestructible machine on the water.

\*Comes with English and Chinese menu.



BEASTMASTER 6000/ 9000							
Model Number	Line Capacity PE [no.-m]	Gear Ratio	Weight [g]	Max Drag [kg]	Practical Power (kg)	Speed [m/min]	Bearings
6000	6-750, 8-600, 10-500, 12-350	3.1	1370	30.0	22	140	16/0
9000	6-1100, 8-900, 10-650, 12-550	3.1	1485	25.0	20	165	14/0

## Light game with a compact electric reel.

It is now very possible for anglers to operate electric reels with only one hand with this machine. The side plate has been reduced in area by 20% to give the reel its compact size and light weight. The location of the cable connecting to the battery has also been moved for better comfort when palming the reel. NEW Touch Drive allows medium speed settings while the Speed Clutch allows you to turn the toggle on and off while thumbing the spool. It is also easier to hook on to fish with the gear ratio increased to high gear. With the MUTEKI+ motor, high speed retrieves and jiggling actions can be achieved effortlessly.

The motor-clutch synchronization cancels out noise from the motor when the jig "falls" or sinks deeper to the ocean floor. For convenience, you also get the handle speed display to show how fast or slow the handle is being turned at. Rest assured this reel will see you through the toughest of days with an internal labyrinth structure to prevent entry of salt water into the body during fishing. The ForceMaster 200 is a compact and technology-densed electric reel Shimano is proud to present to anglers all around.

\*Comes with English menu.



FORCEMASTER 200/ 201/ 201DH								NEW
Model Number	Line Capacity PE [no.-m]	Gear Ratio	Weight [g]	Max Drag [kg]	Practical Power (kg)	Speed [m/min]	Bearings	
200 RIGHT	0.8-270, 1-220, 1.5-150	8.2	395	5.0	3	195	9/1	
201 LEFT	0.8-270, 1-220, 1.5-150	8.2	395	5.0	3	195	9/1	
201DH LEFT	0.8-270, 1-220, 1.5-150	8.2	385	5.0	3	195	9/1	

## The ForceMaster 600 series speedy yet comfortable change in retrieving speed is easily executed with the Touch Drive technology installed on the reinvented electric reel.

Anglers are also able to toggle ON/OFF the clutch smoothly with the quick clutch feature. With a miniature body, this electric reel packs a punch with its highest power at 46kg using the MUTEKI MOTOR+ technology. The ForceMaster 600 represents the establishment of advanced technologies used in a whole new generation of electric reels.

\*Comes with English menu.



FORCEMASTER 600/ 600DH/ 601/ 601DH							
Model Number	Line Capacity PE [no.-m]	Gear Ratio	Weight [g]	Max Drag [kg]	Practical Power (kg)	Speed [m/min]	Bearings
600 RIGHT	2-300, 3-200	5.1	495	8.0	6	195	9/1
600DH RIGHT	2-300, 3-200	5.1	500	8.0	6	195	9/1
601 LEFT	2-300, 3-200	5.1	495	8.0	6	195	9/1
601DH LEFT	2-300, 3-200	5.1	500	8.0	6	195	9/1

## ForceMaster 1000



### Feel the fight even when using an electric reel!

The ForceMaster 1000 brings you both comfort and excitement when it comes to light games as it boasts the power of a size 3000 motor and durability while at the same time, is relatively small and light. Easily operable with only one hand, this reel comes with the NEW Touch Drive and Speed Clutch features. The power of the reel comes from the MUTEKI+ motor while the durability is similar to the BeastMaster 1000EJ as they share the same strengthened gear system. It is a mini spartan with power, speed and toughness!

\*Comes with English menu.



FORCEMASTER 1000							
Model Number	Line Capacity PE [no.-m]	Gear Ratio	Weight [g]	Max Drag [kg]	Practical Power (kg)	Speed [m/min]	Bearings
1000	2-600, 3-400, 4-300, 5-200	5.3	680	15.0	8.5	210	11/1

## ForceMaster 2000



The new ForceMaster 2000 has almost the same power as its 3000 size counterpart by adopting high quality electronic magnet motor MUTEKI MOTOR+.

Max retrieve speed is 210m/min. Super free spool, e-centering system, sensitive retrieve speed control system and electric constant speed retrieve control. This compact Force Master will open the new gate to power game with light tackle.



FORCEMASTER 2000							
Model Number	Line Capacity PE [no.-m]	Gear Ratio	Weight [g]	Max Drag [kg]	Practical Power (kg)	Speed [m/min]	Bearings
2000	3-500, 4-400, 5-300	5.1	685	15.0	8.5	210	11/1

## ForceMaster 3000



### Toughness layered on top of Power.

The Forcemaster 3000 is made for fields which require power + durability such as Tunas, Amberjacks, GTs and Apollo style squidding but with the added convenience of a smaller model (3000). The power is guaranteed from the MUTEKI MOTOR+ also found in the 2017 Forcemaster 3000XP while the durability is derived from a strengthened gear system.

The latest Forcemaster 3000 is a trusty partner which focuses on power and durability for a variety of situations and is small enough to easily bring around for your fishing trips!



FORCEMASTER 3000							
Model Number	Line Capacity PE [no.-m]	Gear Ratio	Weight [g]	Max Drag [kg]	Practical Power (kg)	Speed [m/min]	Bearings
3000	4-450, 5-350, 6-300, 8-200	3.9	795	20.0	11	170	10/1

# ForceMaster 6000



The long-awaited ForceMaster 6000 will be a must have item in your arsenal when aiming for Yellowfin Tunas and stopping these swimmers in their tracks.

Complementing the toughness provided by HAGANE body is a combination of a cold forged aluminium clutch lever and a drag strength of up to 30kg on the reel. A handle knob made of C14+ material adds luxury when held in your hands. With the Heat Free System II, high loads at high temperatures have become a trouble of the past. The latest ForceMaster 6000 is an electric which does not even flinch even when faced with monsters of the deep seas!

\*Comes with English menu.



FORCEMASTER 6000							
Model Number	Line Capacity PE [no.-m]	Gear Ratio	Weight [g]	Max Drag [kg]	Practical Power (kg)	Speed [m/min]	Bearings
6000	6-750, 8-600, 10-500, 12-350	3.1	1390	30.0	14	135	5/0

# ForceMaster 9000



With the extra boost in size and power, the ForceMaster 9000 is a must have when venturing into deep sea expeditions.

Paired with the HAGANE body on this reel are an improved drag system, a cold forged aluminium clutch lever and the Heat Free System II. The advanced technologies on the reel are what make it possible for this machine to aggressively hunt for the larger species in deeper waters. The new and improved handle knob made with C14+ material assures you of its steady grip while making sure it looks good on you during usage too!

\*Comes with English menu.



FORCEMASTER 9000							
Model Number	Line Capacity PE [no.-m]	Gear Ratio	Weight [g]	Max Drag [kg]	Practical Power (kg)	Speed [m/min]	Bearings
9000	6-1100, 8-900, 10-650, 12-550, 15-350	3.1	1495	25	14	140	3/0

# PLAYS 600



PLAYS 600 is a basic model with extensive capabilities for Electric Light Game Fishing styles.

With a line capacity of 300m for PE 2.0 lines and 200m for PE 3.0 lines, PLAYS 600 is a model for light game fishing. Although being an electric reel for light game, the power and speed of this reel is comparable to the higher end electric reel models Shimano has to offer.

Featuring Super Free Spool, Raku-Raku mode, Heat Free System and Super Slow Retrieve, this reel is packed with technology and functions an electric reel should have. With a C14+ knob which fits snug when held and a 65mm handle, cranking becomes a comfortable task for anglers.



PLAYS 600							
Model Number	Line Capacity PE [no.-m]	Gear Ratio	Weight [g]	Max Drag [kg]	Practical Power (kg)	Speed [m/min]	Bearings
600	2-300, 3-200, 4-150	5.0	470	5.0	3	155	5/1

## PLAYS 800/1000



1000

## PLAYS 3000XP/3000



3000XP

## PLAYS 4000



The concept of design is "Basic yet Powerful".

Species of small to large sizes all fall into the hit zone of the PLAYS 800/1000. The first part of the concept is "Basic" - to achieve an electric reel capable of being handled in only one hand when involved in light game out at sea. The second part, "Powerful" - to allow anglers to be free of worry when it comes to targeting and hunt for a wide variety of species in terms of size. Small in size it may be, the PLAYS 800/1000 come with the high-functioning MUTEKI MOTOR and low profile made possible with the light and compact design. Providing anglers with an average power of 6kg and a maximum retrieval rate of 190m per minute, these electric reels pride themselves in allowing anglers to be able to hold the reel in one hand while still being able to access the clutch with ease and comfort.



### PLAYS 800/ 1000

Model Number	Line Capacity PE [no.-m]	Gear Ratio	Weight [g]	Max Drag [kg]	Practical Power (kg)	Speed [m/min]	Bearings
800	3-300, 4-250	5.1	615	10.0	6	190	8/1
1000	3-400, 4-300, 5-200	5.1	615	10.0	6	190	8/1

Other than the basic model that is the 3000, the power type 3000XP is also in the new line-up.

The more powerful 3000XP is decorated with red parts developed by coordinating the use between the speed lever and the handle. Whether it is the powerful 3000XP or the speed focused 3000 model, select the highest performing electric reel of your choice by considering the target fish and the preferred fishing style. pride themselves in allowing anglers to be able to hold the reel in one hand while still being able to access the clutch with ease and comfort.



### PLAYS 3000XP/ 3000

Model Number	Line Capacity PE [no.-m]	Gear Ratio	Weight [g]	Max Drag [kg]	Practical Power (kg)	Speed [m/min]	Bearings
3000XP	4-400, 5-350, 6-300, 8-200	3.9	685	15.0	7.5	150	7/0
3000	4-400, 5-350, 6-300, 8-200	3.9	690	15.0	6	190	7/0

Perfect for light to intermediate deep sea fishing, the PLAYS 4000 churns out an average motor power equivalent to 10kg at a speed of 170m per minute.

It is one of the most suitable machines in the lineup when facing large contenders such as the Dogtooth. Being able to hold as much as 500m of PE 6.0 rating line, the electric reel is a primary tool which provides support to anglers who wish to get a taste of the DENDOU action. Its sturdy Hagane body suppresses the reel's tendency to deform, allowing anglers to crank the reel with peace of mind even under high stress loads. With all the advanced technologies including the motor and drag power, the PLAYS 4000 makes an even greater appeal with its reasonable price point.



### PLAYS 4000

Model Number	Line Capacity PE [no.-m]	Gear Ratio	Weight [g]	Max Drag [kg]	Practical Power (kg)	Speed [m/min]	Bearings
4000	5-600, 6-500, 8-300, 10-270	3.2	1230	15.0	10	170	2/0



# ELECTRIC REEL

## MAINTENANCE TIPS

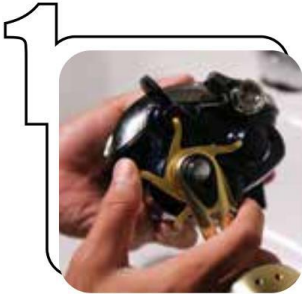

Tighten star drag and cast control cap before washing



Cover socket with rubber socket cap

### DOS

- ✓ Wash your reels with warm water (under 30 degrees Celcius.)
- ✓ Detergent can be used if stubborn stains could not be removed.
- ✓ Washing your reels after every trip
- ✓ Remove line after deep sea fishing or intending to keep for long time storage.
- ✓ Avoid placing the reel on boat side rod holders to prevent splashes of sea water



Quick run through of low pressure water on screen (not more than 3 seconds)



Rinse the spool area for removal of remaining salt

### DON'TS

- ✗ Wash the screen for too long as water might penetrate
- ✗ Wash the reel when the motor is still hot
- ✗ Use chemicals like gasoline/kerosene/Benzene to wash down reel as it will damage the coating
- ✗ Wash your reel when the socket is not covered
- ✗ Wash when star drag and cast control is not tightened
- ✗ Dip or soak the whole reel into a bucket of fresh water
- ✗ Use high pressure water to wash down your electric reel
- ✗ Place under direct sunlight after washing



Engage clutch and pull out 2-3 meter of line while running low pressure water



Use a toothbrush to brush the handle shank and handle knob area



Use a tube brush to brush small accessible area (Reel seat, Line guide area) to ensure removal of remaining salt



Use a wet cloth to wipe down the whole reel to ensure remaining salt and bait is removed



Use a dry cloth to wipe down completely



Use an air duster to spray difficult access area to clear off water droplets

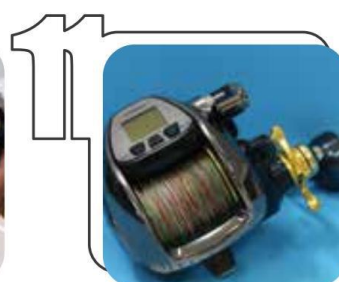

Loosen star drag and leave in a dry and cool place

































### Note:

This is a general guide for reel maintenance. For detailed reel maintenance, please refer to the product instruction manual.





# GLOSSARY

Reel Technology	Explanation	Reel Technology	Explanation
 HAGANE GEAR	Hagane is the concept of power. By using a cold forging technique, we produced a class-leading drive gear that is stronger and more durable.	 S3D	S3D The Shimano Stable Spool Design technology features balanced and uniform thin wall aluminium construction throughout the spool. This precision significantly reduces spool vibration and creates an incredibly smooth feeling when casting and retrieving.
 MICROMODULE	With gear teeth super-refined to the limit, the "Micro Module Gear System" enables seamless engagement and power transmission. The System, without compromising strength, reduces noise and provides you with far better sensitivity.	 IDC+	IDC+ I DC+ is the latest development in automatic cast control. This new digitally controlled braking system makes adjustments by the angler unnecessary, resulting in smoother, more accurate and backlash free casts.
 X-SHIP	X-SHIP stands for Extra, Smooth and High Power. By supporting the pinion gear on both ends with S A-RB bearings (on Stella models) and introducing a bigger drive gear, Shimano increased gearing efficiency and high power. This results in a fishing reel with ultra-light handle rotation for less effort, even under heavy loads. This increases the efficiency of the reel, meaning it will stay smoother and perform at its peak for much longer	 SVS INFINITY	SVS INFINITY SVS Infinity provides 4-6 settings and an adjustable brake dial to provide a much wider and more precise range for maximum control and consistent brake performance in all conditions.
 HAGANE BODY	The Hagane body is a metal reel body with high rigidity. The body stiffness and impact resistance virtually eliminates body flexing. The result transforms the angler's actions directly into cranking power.	 EXCITING DRAG SOUND	EXCITING DRAG SOUND This audible and highly exciting sound, which occurs when a fish runs, is a modern alternative to the traditional clicker or ratchet.
 MGL ROTOR	The redesigned Magnulite Rotor delivers ultra light, almost friction free rotation, enabling you to control the retrieve with ultimate precision and sensitivity. Lures become even more animated when using the MGL Rotor reel, and the ultra light experience lets you feel every movement of the lure, the bottom and ultimately the strike of the fish, no matter how slight it is.	 S COMPACT BODY	S COMPACT BODY Compact body design to reduce weight and allow for better grip and leverage while fighting a fish.
 CORE PROTECT	The concept of Core Protect is simple, to provide water resistance without creating a heavy rotation feeling. There are three key areas of the reel that require protection: the roller clutch, the body and the line roller.	 X DRAG	X DRAG It's all about leverage! We've repositioned the reel handle closer to the body to increase cranking leverage, rigidity and torque, as found in the Calcutta D reels.
 G FREE BODY	G Free Body technology has been developed to shift the reel's centre of gravity closer to the rod. This has been achieved by moving the oscillation mechanism 19mm up from the bottom of the reel to the top. By moving the centre of gravity closer to the angler's hand position, the G Free Body helps to reduce fatigue and enhances casting comfort.	 RIGID SUPPORT DRAG	RIGID SUPPORT DRAG Rigid support drag eliminates spool movement and wobble, even at light drag settings. The result is an incredibly smooth drag even at extremely light settings.
 X-SHIELD	By placing sealing gaskets in 12 critical locations throughout the rigid aluminium body, we are able to create a water resistant structure that can hold up against the toughest conditions and fish that Mother Nature has to offer.	 S A-RB	S A-RB Shielded Anti-Rust bearings are similar to A-RB, but feature additional shields for the ultimate protection.
 X-PROTECT	The first in lip in the proprietary three-lipped rubber seal system is designed to keep low pressure water out. The grease between the second and third lips resists high pressure water while enhancing a smooth rotor rotation.	 A-RB	A-RB Anti-Rust Bearing possess extreme durability, at least 10 times the corrosion resistance of standard stainless steel bearing.
 X-TOUGH DRAG	Incorporating large diameter drag washers at the base of the spool provides greater drag stability. The result is smooth and consistent drag performance throughout the fight. The Coil Wave Spring features steady elasticity at any compression level, and little deformation under repeated compression. This results in precise drag adjustments throughout the curve, giving the angler more control at high pressure.	 ONE-PIECE BAIL	ONE-PIECE BAIL One piece bail allows the line to travel unimpeded to the line roller. Its seamless design reduces friction and the chance of tangles or cut to the bail arm.
 AR-C SPOOL	Through tens of thousands of casting tests and computer simulations, it has been determined that AR-C spool lip design produces longer casting distances than a standard spool lip, while preventing backlashes and wind knots from forming. It also allows the line to flow off the spool in smaller loops during the cast, which means less slap on the strip per guide. This results in longer casts with less friction.	 SUPER FREE SPOOL	SUPER FREE SPOOL Eliminates friction on the spool shaft for increased free spool. The result is a longer cast requiring less effort.
 C14	C14 is a material created by the interfusion of carbon and polyamide. The upshot is a reel whose precision inner workings are housed within a protective shell with all the performance advantages of metal, but weighing less and therefore reducing arm fatigue whilst increasing feel and balance throughout the rod.	 AERO WRAP II	AERO WRAP II Aerowrap II is a worm gear oscillation system with a specially designed pitch to create optimal oscillation speeds for the AR-C lip design. It provides uniform line lay and winding shape to prevent loss of energy during a cast, while providing longer casts than other oscillation systems.
 C14+	We have upgraded our light-weight carbon material C14. Keeping it light weight, rigidity and durability of the material under fishing conditions are highly improved. From this characteristic, we were able to reduce the volume and weight of the rotor and the body.	 VARISPEED II	VARISPEED II Varispeed with extra teeth on the main gear to enhance line lay.
 LONG STROKE SPOOL	The long stroke spool design improves casting performance when compared to the previous model due to the improved line flow from the spool.	 VARISPEED	VARISPEED Consistent spool speed is achieved by altering the speed of the oscillation cam. This results in an even line lay, delivering excellent casting and overall manageability.
		 TOUCH DRIVE	Touch Drive Anglers can now easily choose the exact level of speed required, making even super slow retrieves possible with this electric reel. Touch Drive [] can also be accessed through the mode setting on the electric reel.
		 HEAT SINK DRAG	Heat Sink Drag By installing a heat sink panel which channels heat generated from the drag away from the spool, the negative effects of high heat on the spool have been successfully reduced by 50%. A heat insulator sheet is also installed to ensure the heat away from the lines on the spool, resulting in a 30% drop in temperature increments in the line filled area of the spool.
		 MGL SPOOL III	Magnulite spool III The thickness of walls of the spool is minimized without compromising the spool's durability, resulting in a successful reduction in moment of inertia. The NEW Antares is equipped with a 34mm diameter and 19mm width narrow MGL III spool. The moment of inertia of the new spool has been successfully reduced by 15% compared to its predecessor (2nd gen MGL spool).
		 FALL LEVER	Fall Lever Controlling fall speeds with ease and comfort with an all new design. Previously a complicated part of the fishing sport, controlling the fall speed has been made easy and accurate with the fall lever function. Anglers are able to formulate a more strategic approach to fishing for their targets by adjusting different fall speeds in different columns of the ocean. The shape of the lever allows itself to fit perfectly on the reel without disrupting the smooth operability of the reel.

# STELLA



**SPOOL S-27**

**YUMEYA 18 STELLA 1000 F3 SPOOL**

Item Name	Drag Power (kg)	Weight (g)	Spool Design (Dia mm/ Float mm)	Line Capacity	No. of Bearing	Item Code
1000 F3 Spool	2	24	40/13.5	Fluoro (lb-m) 2-120, 3-100, 4-80	1	03969



**SPOOL (1000) S-27**

**SPOOL (2500) S-20**

**YUMEYA 18 STELLA 1000 N4010/1000/2500 F6 SPOOL**

Item Name	Drag Power (kg)	Weight (g)	Spool Design (Dia mm/ Float mm)	Line Capacity	No. of Bearing	Item Code
1000 N4010 SPOOL	2	23	40/13.5	PE (no-m) 0.16-150, 0.8-110, 1-80	1	03900
1000 SPOOL	2	20	40/13.5	PE (no-m) 0.8-240, 1-190	1	03907
2500 F6 SPOOL	2.5	28	47/17	PE (no-m) 0.8-200, 1-160, 1.2-130	1	03901

**SPOOL S-27**

**YUMEYA 18 STELLA C2000 F6 SPOOL**

Item Name	Drag Power (kg)	Weight (g)	Spool Design (Dia mm/ Float mm)	Line Capacity	No. of Bearing	Item Code
C2000 F6 SPOOL	2	24	43/13.5	Fluoro (lb-m) 5-130, 6-100, 8-75	1	03970

**SPOOL S-27**

**YUMEYA 18 STELLA 2500 F3/2500 F4 SPOOL**

Item Name	Drag Power (kg)	Weight (g)	Spool Design (Dia mm/ Float mm)	Line Capacity	No. of Bearing	Item Code
2500 F3 SPOOL	2.5	30	47/17	Fluoro (lb-m) 2-120, 3-100, 4-80	1	03972
2500 F4 SPOOL	2.5	30	47/17	Fluoro (lb-m) 2-120, 3-100, 4-80	1	03973

**SPOOL S-20**

**YUMEYA 18 STELLA 2500 PE0815 SPOOL**

Item Name	Drag Power (kg)	Weight (g)	Spool Design (Dia mm/ Float mm)	Line Capacity	No. of Bearing	Item Code
2500 PE0815 SPOOL	6	30	47/17	PE (No-m) 0.6-200, 0.8-150, 1-110	1	03974



**SPOOL S-20**

**YUMEYA 18 STELLA 2500 PE0820/2500 PE 1215 SPOOL**

Item Name	Drag Power (kg)	Weight (g)	Spool Design (Dia mm/ Float mm)	Line Capacity	No. of Bearing	Item Code
2500 PE0820 SPOOL	6	32	47/17	PE (No-m) 0.8-200, 1-160, 2-130	1	03902
2500 PE1215 SPOOL	6	34	47/17	PE (No-m) 1-190, 2-150, 1.5-210	1	03903

**SPOOL S-28**

**YUMEYA 18 STELLA 4000PE 1515/4000PE 1520 SPOOL**

Item Name	Drag Power (kg)	Weight (g)	Spool Design (Dia mm/ Float mm)	Line Capacity	No. of Bearing	Item Code
4000PE 1515 SPOOL	7	50	52/19	PE (No-m) 1.2-190, 1.5-150, 2-130	1	03975
4000PE 1520 SPOOL	7	45	52/19	PE (No-m) 1.2-250, 1.5-200, 2-150	1	03976

**SPOOL S-28**

**YUMEYA 18 STELLA 4000 PE1015/4000 PE1215/4000 PE2020 SPOOL**

Item Name	Drag Power (kg)	Weight (g)	Spool Design (Dia mm/ Float mm)	Line Capacity	No. of Bearing	Item Code
4000 PE1015 SPOOL	7	54	52/19	PE (No-m) 0.8-190, 1-150, 1.5-100	1	03904
4000 PE1215 SPOOL	7	53	52/19	PE (No-m) 1-190, 2-150, 1.5-120	1	03905
4000 PE2020 SPOOL	7	50	52/19	PE (No-m) 1.5-265, 2-200, 2.5-160	1	03906

# COLTSNIPER



**SPOOL S-28**

**YUMEYA CUSTOM SPOOL 4000 PE1520 /4000 PE2020 (COLTSNIPER COLOR)**

Item Name	Drag Power (kg)	Weight (g)	Spool Design (Dia mm/ Float mm)	Line Capacity	No. of Bearing	Item Code
4000 PE 1520 SPOOL	11	45	52.0/19.0	PE (No-m) 1.2-250, 1.5-200, 2-150	1	04106
4000 PE 2020 SPOOL	11	47	52.0/19.0	PE (No-m) 1.5-265, 2-200, 2.5-160	1	04107

# Soare



**SPOOL S-29**

**YUMEYA CUSTOM SPOOL (SOARE COLOR)**

Item Name	Drag Power (kg)	Weight (g)	Spool Design (Dia mm/ Float mm)	Line Capacity	No. of Bearing	Item Code
1000 N4010 SPOOL	3	25	40.0/13.5	PE (No-m) 0.6-150, 0.8-110, 1-80	1/0	04102
C2000 N4010 SPOOL	3	24	40.0/13.5	PE (No-m) 0.3-120, 0.4-90	1/0	04103



**SPOOL (PE0315) S-4**

**YUMEYA SPOOL TYPE II (SOARE COLOR)**

Item Name	Drag Power (kg)	Weight (g)	Spool Design (Dia mm/ Float mm)	Line Capacity	Item Code
PE0315 (S-4)	2.5	31	43/14.5	PE (No-m) 0.3-150, 4-120	03016

# EXSENCE



**SPOOL S-20**

**YUMEYA CUSTOM SPOOL 2500 PE1215/ 4000 PE1215 (EXSENCE COLOR)**

Item Name	Drag Power (kg)	Weight (g)	Spool Design (Dia mm/ Float mm)	Line Capacity	No. of Bearing	Item Code
2500 PE1215 SPOOL	9	31	47.0/17.0	PE (No-m) 1-190, 1.2-150, 1.5-120	1	04104
4000 PE1215 SPOOL	11	45	52.0/19.0	PE (No-m) 1-190, 1.2-150, 1.5-120	1	04105

# Sephia



**SPOOL S-20**

**YUMEYA CUSTOM SPOOL 2500PE 0815 /2500PE 0820 SPOOL (SEPHIA COLOR)**

Item Name	Drag Power (kg)	Weight (g)	Spool Design (Dia mm/ Float mm)	Line Capacity	No. of Bearing	Item Code
2500PE 0815 SPOOL	9	31	47/17	PE (No-m) 0.6-200, 0.8-150, 1-120	1	04058
2500PE 0820 SPOOL	9	33	47/17	PE (No-m) 0.6-200, 0.8-150, 1-120	1	04059



**SPOOL S-4**

**YUMEYA CUSTOM SPOOL 2500PE 0815 /2500PE 0820 SPOOL (SEPHIA COLOR)**

Item Name	Drag Power (kg)	Weight (g)	Spool Design (Dia mm/ Float mm)	Line Capacity	Item Code
PE0615 SPOOL	3.5	37	46.5/14.5	PE (No-m) 0.4-210, 0.6-150, 0.8-100	03017
PE0820 SPOOL	3.5	34	46.5/14.5	PE (No-m) 0.8-200, 1-150, 1.2-100	03018

# STELLA SW

SPOOL S-29



## YUMEDA 20 STELLA SW18000 POWER HOOKING SPOOL

Item Name	Drag Power (kg)	Weight (g)	Spool Design (Dia mm/ Float mm)	Line Capacity	No. of Bearing	Item Code
18 POWER H-SP	17	185	72.0/28.0	PE (No-m) 5-500, 6-400, 8-300	2	04251



SPOOL S-29



## YUMEDA 20 STELLA SW20000 MAX SPOOL

Item Name	Drag Power (kg)	Weight (g)	Spool Design (Dia mm/ Float mm)	Line Capacity	No. of Bearing	Item Code
20MAX-SP	17	215	80.0/28.0	PE (No-m) 6-600	2	04252

## Handle Knob TYPE A

Handle Knob A



### YUMEDA HANDLE KNOB EVA ROUND TYPE S

Item Name	Weight (g)	Item Code
Round S	9	04030



Handle Knob A



### YUMEDA HANDLE KNOB I-SHAPE TYPE SS

Item Name	Weight (g)	Item Code
I type SS	2.3	03909



Handle Knob A



### YUMEDA ALUMINIUM ROUND POWER KNOB

Item Name	Weight (g)	Item Code
BLACK/ GOLD S	19	02712
BLACK/ GOLD M	25	02627
BLUE S	19	02713
BLUE M	25	02682
GREY S	19	02714
GREY M	25	02683



Grey M

Handle Knob A



### HANDLE KNOB EVA I-SHAPE LONG

Item Name	Weight (g)	Item Code
EVA LONG HANDLE KNOB I	7	02616



Handle Knob A



### YUMEDA EVA POWER ROUND HANDLE KNOB

Item Name	Weight (g)	Item Code
EVA POWER ROUND KNOB M	11	02635



Handle Knob A  
HANDLE H-2



### YUMEDA ALUMINIUM DOUBLE HANDLE 45MM

Item Name	Weight (g)	Length (mm)	No. of Bearings	Item Code
ALUMINIUM DOUBLE HANDLE 45MM	46	45	2	03434



## Handle Knob TYPE B

HANDLE KNOB B

HANDLE (48mm) BH-1

HANDLE (55mm) BH-2



### YUMEDA ULTRA STRONG HANDLE 48MM / 55MM

Item Name	Weight (g)	Length (mm)	No. of Bearings	Item Code
48MM	TBC	48	4	04373
55MM	TBC	55	4	04374



55MM



48MM

HANDLE KNOB B



### YUMEDA RUBBER T-TYPE POWER HANDLE

Item Name	Weight (g)	Item Code
RUBBER T-TYPE HANDLE KNOB M	37	03585



HANDLE KNOB B



### YUMEDA C14+ ROUND HANDLE KNOB L

Item Name	Weight (g)	Item Code
C14+ ROUND HANDLE KNOB	26	03586



HANDLE KNOB B



### YUMEDA EVA POWER ROUND KNOB L

Item Name	Weight (g)	Item Code
EVA POWER ROUND KNOB L	18	02630



HANDLE KNOB B



### YUMEDA ALUMINIUM POWER ROUND KNOB

Item Name	Weight (g)	Item Code
BLACK/ GOLD M	26	02628
BLACK/ GOLD L	32	02629
BLUE M	26	02684
BLUE L	32	02686
GREY M	26	02685
GREY L	32	02687



Blue L



Black/ Gold L

REEL

SPINNING

SPINNING SW

SPINNING SURF

BAITCAST REELS

BAITCAST SW

SW OVERHEAD

ELECTRIC REELS

YUMEDA

## [SPINNING REEL]

YEAR	MODEL NAME	SIZE	DRAG KNOB	SPOOL	REEL STAND	HANDLE	HANDLE KNOB	HANDLE SCREW CAP
2022	STELLA	1000SSPG	—	S-30	C/E	H-10	A	HC-3
		C2000S/C2000SHG	—	S-27	C/E	H-10	A	HC-3
		C2500S/C2500SXG	—	S-27 S-31	C/E	H-10	A	HC-3
		2500S/2500SHG/C3000SDHG/C3000SDHGG/C3000MHG/C3000XG/3000MHG	—	S-20	C/E	H-11	A	HC-2
		4000M/4000MHG/4000XG/C5000XG	—	S-28	C/E	H-11	A	HC-2
2019	VANQUISH	1000SSPG/C2000S/C2000SS/C2000SHG	—	S-27	C/D	H-10	A	HC-1
		C2500SHG/C2500SXG	—	S-27	C/D/E	H-11	A	HC-2
		2500S/2500SHG/C3000/C3000MHG/C3000SDHG/C3000XG/C3000SDH/3000MHG	—	S-20	C/D/E	H-11	A	HC-2
		4000MHG/4000XG/C5000XG/C5000HG	—	S-28	C/D/E	H-11	A	HC-2
		C2000S/C2000SHG	—	S-27	C	H-10	A	HC-1
2020	TWIN POWER	2500S/2500SHG/C3000/C3000MHG/C3000XG	—	S-20	C/D/E	H-11	A	HC-2
		3000MHG	—	S-20	C/D/E	H-11	A	HC-2
		4000/4000PG/4000MHG/4000XG/C5000XG	—	S-28	C/D/E	H-11	A	HC-2
		C3000HG/C3000XG	—	S-20	C	H-11	A	HC-2
2021	TWIN POWER XD	4000PG/4000HG/4000XG/C5000XG	—	S-28	C/E	H-11	A	HC-2
		C3000HG	—	S-23	C/E	H-2	A	HC-2
2017	SUSTAIN	3000XG	—	S-23	C/D/E	H-2	A	HC-2
		4000XG/C5000XG	—	S-24	C/D/E	H-2	A	HC-2
		C2000S/C2000SHG	—	S-27	C	H-10	A	HC-1
2020	VANFORD	C2500SHG	—	S-27	C/D/E	H-11	A	HC-2
		2500S/2500SHG/C3000/C3000SDHG/C3000SDHGG/C3000MHG/C3000XG/3000MHG	—	S-20	C/D/E	H-11	A	HC-2
		4000/4000MHG/4000XG/C5000XG	—	S-28	C/D/E	H-11	A	HC-2
2019	STRADIC	1000S/C2000S/C2000SHG	—	S-27	C	H-10	A	HC-1
		2500S/2500SHG/C3000/C3000HG/C3000XG/3000MHG	—	S-20	C/D/E	H-11	A	HC-2
		4000/4000MHG/4000XG/C5000XG	—	S-28	C/D/E	H-11	A	HC-2
2021	ULTEGRA	1000/C2000S/C2000HGS	—	—	C	H-10	A	HC-1
		2500/2500SHG/C3000/C3000HG/C3000XG	—	—	C/E	H-11	A	HC-2
2021	EXSENCE	4000/4000XG/C5000XG	—	—	C/E	H-11	A	HC-2
		C3000MHG/C3000M/3000MHG	—	S-20	C/E	H-11	A	HC-2
2018	EXSENCE CI4+	4000MXG	—	S-28	C/E	H-11	A	HC-2
		C3000M/C3000MHG	—	S-23	C/E	H-2	A	HC-2
		3000MHG	—	S-23	C/D/E	H-2	A	HC-2
		4000MXG	—	S-24	C/D/E	H-2	A	HC-2
2020	EXSENCE BB	C3000MHG	—	—	C/E	H-2	A	HC-2
		3000MHG	—	—	C/E	H-2	A	HC-2
		4000MHG / 4000MXG	—	—	C/E	H-2	A	HC-2
2015	AR-C AERO BB	C3000HG	—	—	—	—	A	—
2014		4000/4000HG/5000HG	—	—	D	—	A	HC-2
2021	SEPHIA XR	C3000S/C3000SDHG/C3000SHG/C3000SDHGG	—	S-20	C/E	H-11	A	HC-2
2019	SEPHIA SS	C3000S / C3000SDH / C3000SHG / C3000SDHGG	—	S-23	C/E	H-2	A	HC-2
2018	SEPHIA BB	C3000S/C3000SHG/C3000SDHG/C3000SDHGG	—	—	C/E	H-2	A	HC-2
2021	SOARE XR	C2000SSPG/C2000SSHG	—	S-27	C	H-10	A	HC-1
		C2500S	—	S-27	C/E	H-11	A	HC-2
		500SPG	—	—	C	H-10	A	HC-1
2018	SOARE BB	500S/C2000SSPG/C2000SSHG	—	—	C	H-1	A	HC-1
2018	CARDIFF CI4+	1000S/1000SHG	—	S-22	C	H-1	A	HC-1
		C3000MHG	—	S-23	C/E	H-2	A	HC-2
		C2000 F4/C2000 F4 HG	—	S-27	C	H-10	A	HC-1
2021	COMPLEX XR	2500 F6/2500 F6 HG	—	S-20	C/E	H-11	A	HC-2
2010	AORISTA CI4	2500/2500S/C3000	—	—	D	—	A	HC-2
2013	AORISTA BB	2500/C3000HG/4000	—	—	—	—	A	—
2020	STELLA SW	4000HG/4000XG	—	S-3 S-28	D	—	B	HC-2
		5000HG/5000XG/6000PG/6000HG/6000XG	D-6	S-7	D	—	B	HC-2
		20000PG/18000HG	—	S-29	—	H-12	B	—
		30000	—	—	—	—	B	—
		8000PG/8000HG	D-7	—	—	H-4	B	—
2019	TWIN POWER SW	10000PG/10000HG/14000PG/14000XG	D-7	S-10 S-17	—	H-4	B	—
		4000XG	—	S-3 S-28	D	—	B	HC-2
		5000HG/5000XG/6000PG/6000HG/6000XG	D-6	S-7	D	—	B	HC-2
2021	TWIN POWER SW	8000PG/8000HG	D-7	—	—	H-4	B	—
		10000PG/10000HG/14000PG/14000XG	D-7	S-17	—	H-4	B	—
		4000HG/4000XG	—	S-28	C/D/E	H-11	B	HC-2
2020	STRADIC SW	5000PG/5000XG/6000PG/6000HG/6000XG	—	—	—	—	B	—
		8000PG/8000HG/10000HG	—	—	—	—	B	—
2019	SPHEROS SW	3000XG / 4000HG / 4000XG	—	—	C/D/E	H-2	A	HC-2
2021		5000HG/6000PG/6000HG/8000PG/8000HG	—	—	—	B	—	

※When installing on the model with the color on the left, a separate handle fixing bolt (part code <707102S2500>) and washer (part code <70725481000>) are required. In this case, the handle cannot be folded.

## [LEVER BRAKE REEL]

YEAR	MODEL NAME	SIZE	DRAG KNOB	SPOOL	REEL STAND	HANDLE	HANDLE KNOB	HANDLE SCREW CAP	BRAKE LEVER
2021	BB-X TECHNIUM	2500DXGSR/2500DXGSL/C3000DXGSL/C3000DXGSR/C4000DTYPE-GSR	—	B-2	—	—	A	—	L-2
2020	BB-X HYPERFORCE	1700DXG/C2000DXG/C2000DXXG/PE0815DXXG	—	B-4	C/D/E <sup>※1</sup>	H-2	A	HC-2	L-1
2017		2500DXG S LEFT/C3000D TYPE-G S RIGHT/C3000DXG S LEFT C3000DXG S RIGHT/C3000DXXG S RIGHT/C4000DXG S LEFT	—	B-1	—	—	A	—	L-1
2016		BB-X DESPINA	C3000DXG	—	B-1	—	H-9	A	—
2016	BB-X LARISSA	2500DHG/2500DXG/C3000DHG/C3000DTYPE-G	—	B-1	C/D/E	H-2	A	HC-2	L-1
2018	BB-X RENMARE	5000DHG	—	B-2	C/D/E	—	A	HC-2	L-1
2022		6000D/8000D	—	B-3	C/D/E	—	A	HC-2	L-1
2022	BB-X RINKAI SP	1700DXXG	—	B-4	C/D/E <sup>※1</sup>	H-2	A	HC-2	L-1

※1 Compatible with C type reel stands. However, in the event that there are gaps or difficulties in placing the reel on the C-type stand, please remove the O-ring on the side of the reel stand.

※ YUMEYA PRODUCTS ARE LIMITED EDITION. PLEASE TAKE GOOD CARE OF THE ORIGINAL PARTS BEFORE CHANGING TO YUMEYA AS IN THE EVENT THAT THE YUMEYA PRODUCT CURRENTLY USED GETS DAMAGED OR LOST, THE ORIGINAL PARTS WILL HAVE TO BE REUSED.

※ THE YUMEYA SERIES COMPRISED OF COMPLETE ASSEMBLED PRODUCTS; THEREFORE PLEASE UNDERSTAND THAT THERE ARE CASES WHERE DAMAGED YUMEYA PARTS CANNOT BE REPAIRED.

[LONG CASTING REEL]

YEAR	MODEL NAME	SIZE	SPOOL	HANDLE	HANDLE KNOB
2022	KISU SPECIAL 45	FINE/CE FILAMENT	C-2	—	B
2017	FLIEGEN	35 EXTRA FINE/ 35 FINE	C-1	—	A
2017	FLIEGEN SD	35 STANDARD	—	—	A
2018	SURFLEADER CI4+	35EXTRA FINE/ 35 FINE	C-1	—	A
		SD35 STANDARD/30 STANDARD /30 FILAMENT	—	—	A
2015	SUPER AERO SPIN JOY SD	35 STANDARD	S-14	—	—
2014	SUPER AERO SPIN JOY	35 FILAMENT/35 STANDARD	C-1	—	—
2013	POWER AERO SPIN POWER	STANDARD /THICK/EXTRA THICK	P-1	—	B
2015	POWER AERO PRO SURF	STANDARD /THICK/ EXTRA THICK	—	—	B
		5050/5080	—	—	B
2014	BULLSEYE	9100/9120	S-14	—	B

[BAITCAST · OVERHEAD REEL]

YEAR	MODEL NAME	SIZE	HANDLE	HANDLE KNOB
2021	ANTARES DC	R/L·HG R/L·XG R/L	BH-1	A
2018	ANTARES	MD XG R/MD XG L	BH-1	A
2019	ANTARES	R/L/HG R/HG L	—	A
2020	METANIUM	R/L H G R/H G L X G R/X G L	BH-1	A
2022	METANIUM SHALLOW EDITION	R/L HG R/HGL XG R/XG L	BH-1	A
2015	METANIUM DC	R/L·HG R/L·XG R/L	BH-1	A
2022	BANTAM	R/L HG R/HG L XG R/XG L	BH-1	A
2018	ALDEBARAN MGL	30/31/30HG/31HG	BH-1	A
2022	ALDEBARAN BFS	HG R/HG L XG R/XG L	BH-1	A
2021	SCORPION DC	150/151/150HG/151HG/ 150XG/151XG	BH-1	A
2021	SCORPION MD	300XG/301XG/ 300XGLH/301XGLH	BH-2 BH-3 BH-4 BH-5	A
2019	SCORPION MGL	150/151/150HG/151HG/ 150XG/151XG	BH-1	A
2017	SCORPION BFS	R/L · XG R/L	BH-1	A
2016	SCORPION	70/71/70HG/71HG/70XG/71XG	BH-1	A
2022	S.L.X.D.C.XT	70/71/70HG/71HG/70XG/71XG	BH-1	A
2020	S.L.X.D.C	70/71/70HG/71HG/70XG/71XG	BH-1	A
2019	SLX MGL	70/70HG/70XG 71/71HG/71XG	BH-1	A
2021	SLX BFS	R/L·XG R/XG L	BH-1	A
2017	BASS ONE XT	R/L	BH-1	A
2018	BASS RISE	BASS RISE/BASS RISE (WITH LINE)	BH-1	A
2020	EXSENCE D.C.S.S	HG R/HG L/XG R/XG L	BH-1	A
2017	EXSENCE DC	XG R/L	BH-1	A
2014	BRENIOS	R/L	—	A
2018	GRAPPLER PREMIUM	150XG/151XG	BH-1	B
2019	GRAPPLER CT	150XG/151XG	BH-1	B
2021	GRAPPLER	150HG/151HG	BH-1	A
2017	GRAPPLER	300HG/301HG	BH-2 BH-3 BH-4 BH-5	B
2016	GRAPPLER BB	200HG/201HG	BH-1	A
2019	ENGETSU CT	150HG/151HG/150PG/151PG	BH-1	A
2018	ENGETSU PREMIUM	150HG/150PG/151HG/151PG	BH-1	A
2021	ENGETSU	100PG/101PG/100HG/101HG	BH-1	A
2017	ENGETSU	150HG/151HG	BH-1	B
2016	ENGETSU BB	100HG/101HG	BH-1	A
2011	SALTY ONE	100PG/101PG	BH-1	A
2020	CALCUTTA CONQUEST D C	100/101/100HG/101HG/ 200/201/200HG/201HG	BH-1	A
2017	CALCUTTA CONQUEST BFS	R/L	BH-1	A
2022	CALCUTTA CONQUEST	200XG/201XG	BH-1	A
2021	CALCUTTA CONQUEST	100/101/200/201/100HG/ 101HG/200HG/201HG	BH-1	A
2019	CALCUTTA CONQUEST	200DC/201DC	BH-1	A
2018	CALCUTTA	300/301/400/401	BH-2 BH-3 BH-4 BH-5	A
2012	CALCUTTA	100/101/200/201	—	A
2013	CALCUTTA	300/301/400/401	—	A
2020	OCEA CONQUEST LIMITED	200 H G/201 H G 200 P G/201 P G	BH-1	B
2019	OCEA CONQUEST LIMITED	300HG/301HG/300PG /301PG/400HG	BH-2 BH-4 BH-5	B
2018	OCEA CONQUEST CT	200HG/201HG 200PG/201PG	BH-1	B
2016	OCEA CONQUEST	300HG/301HG/300PG/301PG	BH-2 BH-4 BH-5	B
2015	OCEA CONQUEST	300PG/301PG	BH-2 BH-4 BH-5	B
2014	OCEA CONQUEST	300HG/301HG	BH-2 BH-4 BH-5	B
2015	OCEA CONQUEST	200HG/201HG 200PG/201PG	BH-1	B
2013	OCEA CALCUTTA	300HG/301HG	BH-2 BH-3 BH-4 BH-5 BH-6	B
2011	OCEA CALCUTTA	200PG/201PG/200HG/201HG	—	A
2020	OCEA JIGGER 4000	4000/4000HG	BH-2 (※2) BH-4 BH-5 BH-6	D
2019	OCEA JIGGER FC	1000HG/1001HG/ 1500HG/1501HG	BH-2 BH-4 BH-5 BH-6	D
		2000NRHG/2001NRHG/3000HG	BH-2 (※2) BH-4 BH-5 BH-6	D
2017	OCEA JIGGER	1000HG/1001HG/1500HG/ 1501HG/1500PG/1501PG	BH-2 BH-4 BH-5 BH-6	B
2021	OCEA JIGGER	1500XG/1501XG	BH-2 BH-4 BH-5 BH-6	D
		2000NRHG/2001NRHG/2000NRPG/ 2001NRPG/2000NRMG/2001NRMG/ 2000NRXG/2001NRXG	BH-2 (※2) BH-4 BH-5 BH-6	D
2020	TORIUM	1500HG	BH-2 BH-4 BH-5 BH-6	B
		2000PG/2000HG	BH-2 (※2) BH-4 BH-5 BH-6	B
2013	TALICA	20 II /25 II	—	B
2012	TALICA	300F/301F/400F/401F	—	A
2013	CALCUTTA F	800F/801F	BH-2 BH-3 BH-4 BH-5 BH-6	B

YEAR	MODEL NAME	SIZE	HANDLE	HANDLE KNOB
2017	SUTTE SS	150PG/151PG/150HG/151HG	BH-1	
2016	SUTTE	100PG/101PG/100HG/ 101HG/100XG/101XG	BH-1	
2017	STEFANO SS	100HG/101HG	—	
2016	STEFANO	100XG/101XG	—	
2020	BAYGAME	300PG/301PG	BH-2 BH-3 BH-4 BH-5	
2018	BAYGAME	150/151	BH-1	
		150DH/151DH	BH-1	
2020	GENPU X T	150/151	BH-1	
		200PG/201PG	BH-1	
2020	GENPU	200PG/201PG	BH-1	
2018	KOBUNE	800/1000/2000/3000	BH-3 BH-4 BH-5	
2020	OCEA JIGGER F CUSTOM	150/151	BH-1	
		150DH/151DH	BH-1	
		150DHXG/151DHXG	BH-1	
2019	BARCETTA PREMIUM	150/151/150DH/151DH/ 150DH XG/151DH XG	BH-1	DOUBLE: A SINGLE: B
2021	BARCETTA	100DHHG/101DHHG/150HG/ 151HG/150DHPG/151DHPG/ 150DHHG/151DHHG	BH-1	DOUBLE: A SINGLE: B
		300PG/300HG	BH-1	
2021	BARCETTA BB	150HG/151HG/150DHPG/ 151DHPG/150DHHG/151DHHG	BH-1	DOUBLE: A SINGLE: B
		300PG/300HG	BH-1	
2018	BARCETTA SC	800/1000/2000/3000	BH-3 BH-4 BH-5	
2015	KAIKON	2000T/3000T/4000T	BH-4	
2009	SPEEDMASTER 石鯛	2000T/3000T/4000T	BH-4	
2020	SEIHAOKU LIMITED	R C 83 R/L	BH-1	
2019	SEIHAOKU S P	RED RIGHT/RED LEFT/ GOLD RIGHT/GOLD LEFT	BH-1	
2012	SEIHAOKU 60	BLUE/GOLD/SILVER	BH-1	
2008	CHINUMATIC	1000SP/1001SP	BH-1	
2008	CHINUMATIC	1000XT/1001XT-1000/1001	BH-1	
2021	BEASTMASTER	3000EJ	BH-4 BH-5 BH-6	
2020	BEASTMASTER	1000EJ	BH-2 BH-3 BH-4 BH-5 BH-6	
		MD3000	BH-4 BH-5 BH-6	
		2000EJ	BH-2 BH-3 BH-4 BH-5 BH-6	
2019	BEASTMASTER	6000/9000	BH-4 BH-5 BH-6	
2018	BEASTMASTER	2000	BH-2 BH-3 BH-4 BH-5 BH-6	
2016	BEASTMASTER	3000XP/3000XS	BH-4 BH-5 BH-6	
2014	BEASTMASTER	6000/9000	BH-4 BH-5 BH-6	
2022	FORCEMASTER	201	BH-1	
		201DH	BH-1	
		3000	BH-4 BH-5 BH-6	
		200	BH-1	
2021	FORCEMASTER	1000	BH-2 BH-3 BH-4 BH-5 BH-6	
2020	FORCEMASTER	600/601	BH-2 BH-3 BH-4 BH-5	
		600DH/601DH	BH-2 BH-3 BH-4 BH-5	
2016	FORCEMASTER	6000/9000	BH-4 BH-5 BH-6	
2019	PLAYS	600	BH-2 BH-3 BH-4 BH-5	
2018	PLAYS	3000XP	BH-4 BH-5	
2017	PLAYS	4000	BH-4 BH-5	
		800/1000	BH-3 BH-4 BH-5	
2016	PLAYS	400	BH-2 BH-3 BH-4 BH-5	
2015	PREMIO	3000	BH-4 BH-5	
		3000	BH-4 BH-5	

※2 A separate washer (parts code <72116074900>) is required for installation.

REEL

SPINNING

SPINNING SW

SPINNING SURF

BAITCAST REELS

BAITCAST SW

BAITCAST SW OVERHEAD

ELECTRIC REELS

YUMEYA

SHIMANO ORIGINAL BLANKS



# SPIRAL CORE

A FURTHER  
STRENGTHENED,  
TOUGH  
FOUNDATION





**TORSIONAL  
STRENGTH**

**1.4x** ※

**COMPRESSION  
STRENGTH**

**2.5x** ※

※ Based on internal comparison test

**NEXT-GENERATION STRUCTURE EVOLVED BY ADOPTING HIGH-STRENGTH MATERIALS.**

#### **| SPIRAL X CORE**

Shimano pursues extreme strength, further strengthening in all directions such as bending, twisting, collapse, etc. by original design and manufacturing methods. Shimano's unique basic structure that enhances rod performance from the core, using carbon tape with high-strength resin achieved by Nano alloy technology in Spiral X.

We achieved further strengthening with carefully selected materials. By comparison with the general structure, the torsion strength increased 1.4 times and the blank strength increased 2.5 times (compared with previous models). Furthermore, by comparison with spiral X, we achieved 10% increase in screw strength and 15% increase in crush strength.

**X**  
**SPIRAL**

**STRONG FROM THE CORE**

**EXCLUSIVE CONSTRUCTION OVERCOMES  
BLANK TWISTS AND ENHANCES ROD  
PERFORMANCE.**

#### **| SPIRAL X**

Spiral X construction consists of three layers: a blank made of vertical fibres, an inner layer and an outer layer both comprised of carbon tape that tightly winds the blank diagonally in opposite directions. By using this carbon tape in place of a conventional horizontal fibre sheet, Spiral X achieves enhanced torsional rigidity without adding extra weight.

This in turn facilitates instant power transmission for precise casting and fighting fish. Through its exclusive lightweight structure, Shimano's Spiral X construction enhances anglers' catching power.

## BLANKS STRUCTURE / MATERIAL / DESIGN

## FULL CARBON MONOCOQUE



The fundamentals of rod building is to maximise the potential of the blanks. On the rod is the reel seat, a crucial terminal communicating information back and forth between the angler above water and the fish under. Shimano has studied what anglers deem as a 'comfortable' gripping experience and shaped the abstract shape into creation.

## CARBON SHELL GRIP



Using a hollowed structure made of carbon bound to the reel seat, the next-gen grip structure makes its entrance. Vibrations are now transmitted more clearly to anglers, resulting in a truly light yet highly sensitive grip.

## NANOPITCH



With the Nanopitch, manufacturing method Shimano is able to wrap a molding tape which is used in the process of baking on a blank finely and with high precision. Because of the Nanopitch method blanks are tightened up to the extreme while at the same time more uniform pressure is applied, the circularity becomes higher and it contributes greatly to the overall rod strength.

## DYNA BALANCE



Dyna Balance relies on a measurement system incorporated on rod actions and is designed to maximise the transmission of vibrations of the lure underwater to the rod. Through the detailed analysis of these measurements, rods with Dyna Balance offers a smooth natural bend.

## UBD



UBD is a technique Shimano uses to choose the most suitable materials for each and every section (tip, belly and butt) of the rod. There are no parts in excess, forming the ideal action profile. UBD allows for a lower overall weight of rods without compromising strength and power. \*Bass rods only

## UBD MULTI-PIECE



By arranging the right material in the right place, the ultimate blanks design that brings weight reduction while maintaining strength and power is further increased, and only in the places where the basic and reinforced structures such as Spiral X Core and High Power X are effective. The multi-piece ultimate blanks design is a new structure that keeps the blanks even lighter while maintaining strength. \*Bass rods only

## CORE BLANKS

Achieving an improved resistance against twists and bends with the Spiral X Core. Parabola Tune creates a smooth bend which minimizes the stress and strain on joints of multi-piece rods. X Guides for optimal rod weight reduction. These three make up the Core Blanks tech and with the highest engineering precision, Shimano's ISO rods are strong, light and reliable!

## SCREW LOCK JOINT



With a simple twist, sections are strongly and securely connected, increasing the joint strength of the rod while providing a worry free environment for fish fights.

## ANTI LOCK JOINT



The Anti-Lock Joint system is a structure which adjusts the location of the stopper in the joint areas to prevent the joints from locking or being stuck when connected too tightly during setup.

## BIOFIBRE



Biofibre construction has been renewed offering increased lifting power and excellent control of fighting fish hard close to the bank or boat.

## TIP

## TAFTEC ∞



An all new development - Taftec ∞ is three times more durable than the typical solid tips with an improved retrieving load by up to 5 times!

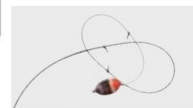

## TAFTEC α



A solid tip that achieves supple and delicate bending while maintaining strength without reducing the diameter of the tip.



## SOFTUBE TOP



Softube Top provides the sensitivity of an ultra fine solid carbon tip with the lightness of a hollow construction.



## HIGH RESPONSE SOLID



Highly elastic solid tip in pursuit of the perfect action. Even with small and light lures, the supple and elastic tip can instantaneously set the hook (quick response). Suitable for aggressive and assertive fishing styles!

## HI-POWER X TIP



A solid tip that achieves supple and delicate bending while maintaining strength without reducing the diameter of the tip.

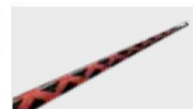

## HI-POWER X SOLID



Enforcing the supple solid tip with carbon tape helps to minimize any power loss or play in the operation of the rod, still giving a natural bend. X Solid Power significantly improves the castability and sensitivity of the rod.



## REEL SEAT / GRIP

## CI4/CI4+



SHIMANO develop a wide range of reel seat designs to match the rod on which they are applied. Some of the more specialised reel seats incorporate the use of CI4 and CI4+ carbon. CI4 is over 20% lighter and 1.6 times stronger than conventional polymers, with CI4+ being a technical advancement of CI4 which offers even more strength. This exclusive material allows SHIMANO to make ultra light reel seats, whilst maintaining the maximum strength

## PERFECTION SEAT XT

On top of improved grip comfort and power transmission from user to rod, the perfection seat XT significantly reduces the weight of the reel seat. A combination of both delicate action and comfort is made possible by optimizing the thickness reel seat shell. \*Carbon-reinforced CI4+ material



## FULL HOLDING SEAT

Whether it's gripping fully, palming, with 2-4 fingers or any kind of holding method, the Full Holding Seat has got you covered. The seat sits perfectly in your hands, supporting you in your power fights against strong tough fish. \*Available on lure rods



## X-SEAT



The fundamentals of rod building is to maximise the potential of the blanks. On the rod is the reel seat, a crucial terminal communicating information back and forth between the angler above water and the fish under. Shimano has studied what anglers deem as a 'comfortable' gripping experience and shaped the abstract shape into creation.





# SALTWATER RODS



OCEA JIGGER LIMITED S62-4

OCEA JIGGER LIMITED B62-4

OCEA JIGGER CONCEPT S

## OCEA JIGGER LIMITED

Shimano's highest peak "LIMITED" aims for performance that exceeds the limits of slow jigging rods in terms of sensitivity and operability.

Ultra-high sensitivity and ultra-high power output are achieved by fusing Shimano's rod technology and know-how that have been refined over many years. The light hollow structure of the hard carbon shell grip helps anglers by transmitting vibrations picked up from fish and changes in the tidal current to the hands of anglers. The full holding reel seat enables you to use different gripping techniques comfortably while the X Guide system achieves both trouble-free performance and smooth line outlay by optimizing the shape and angle of the guides to the blanks.

The slim, supple yet highly elastic blanks allows these rods to bend like bows and helps jigs perform the best they can, creating a fascinating fall action. The slim blanks may seem like a full solid rod, but the Spiral X Core and Hi-Power X go hand in hand to provide high torsional rigidity, solving blurring and power loss issues. In addition, the translation of low input from anglers to high output on the rods makes it possible to continuously produce a highly accurate jig action even in situations where there is strong pulling resistance from fast currents and double tides. Ocea Jigger Limited rods maximizes the ultra-high sensitivity and ultra-high output on slender, lightweight, highly resilient blanks, giving jigs the exact action its users want. These rods will take jigging to a whole new dimension.



### OCEA JIGGER LIMITED (SPINNING)

NEW

Model Number	Rod Length [m]	No. of Sections	Closed Length [cm]	Weight [g]	Lure Weight [g]	Line Weight [PE]	Type
S62-1	1.88	1	188.0	TBC	70 ~ 160	MAX2.5	SPINNING
S62-2	1.88	1	188.0	TBC	80 ~ 180	MAX2.5	SPINNING
S62-3	1.88	1	188.0	TBC	90 ~ 200	MAX3	SPINNING
S62-4	1.88	1	188.0	TBC	110 ~ 240	MAX4	SPINNING
S510-5	1.78	1	178.0	TBC	130 ~ 280	MAX5	SPINNING



### OCEA JIGGER LIMITED (BAITCAST)

NEW

Model Number	Rod Length [m]	No. of Sections	Closed Length [cm]	Weight [g]	Lure Weight [g]	Line Weight [PE]	Type
B62-0	1.88	1	188.0	126	40-130	MAX1.5	BAITCAST
B62-1	1.88	1	188.0	127	80-180	MAX1.5	BAITCAST
B62-2	1.88	1	188.0	133	100-230	MAX2	BAITCAST
B62-3	1.88	1	188.0	138	120-280	MAX2.5	BAITCAST
B62-4	1.88	1	188.0	145	140-350	MAX3	BAITCAST
B62-5	1.88	1	188.0	TBC	160-430	MAX3	BAITCAST
B62-6	1.88	1	188.0	TBC	180-500	MAX4	BAITCAST

## OCEA JIGGER CONCEPT S

Giving off a sense of speedy operability during jigging is the new spinning rod, Ocea Jigger Concept S.

The rod is lightweight and packed with power and balance for an enjoyable and stress-free spinning jigging experience. In order to materialize the concept of stress-free, the key goals were Slim, Smooth, Strong. Equipped with Spiral X technology, the slender and light rod is made with a highly recoiling blank. Regardless of the strength of the backbone of the rod, the smooth bend or curvature of the rod plays a role in reducing the load and fatigue of anglers.



### OCEA JIGGER CONCEPT S

Model Number	Rod Length [m]	No. of Sections	Closed Length [cm]	Weight [g]	Lure Weight [g]	Line Weight [PE]	Type
S64-1	1.93	1	193.0	145	60-150	MAX2.5	SPINNING
S64-2	1.93	1	193.0	145	80-160	MAX2.5	SPINNING
S67-2	2.01	1	201.0	150	80-160	MAX2.5	SPINNING
S62-3	1.88	1	188.0	150	90-180	MAX3	SPINNING
S66-3	1.98	1	198.0	155	90-180	MAX3	SPINNING
S62-4	1.88	1	188.0	157	100-210	MAX4	SPINNING
S66-4	1.98	1	198.0	160	100-210	MAX4	SPINNING
S60-5	1.83	1	183.0	165	120-250	MAX5	SPINNING

# OCEA JIGGER

Ocea Jigger (Spinning)

Shimano OCEA series - This name is well known to the angling field for its powerful, reliable and long lasting performance. With that in mind Shimano's engineers came out with the OCEA JIGGER rods which is what all anglers demand, an excellent built jiggering rod. The blanks are made with our Spiral X process and reinforced through Hi-Power X. All rods come standard with Fuji Titanium SIC guides.



※1 : SHORT LENGTH MODEL

OCEA JIGGER							
Model Number	Rod Length [m]	No. of Sections	Closed Length [cm]	Weight [g]	Lure Weight [g]	Line Weight [PE]	Type
<b>NATURAL JERK</b>							
S641	1.93	1	193.0	190	50-160	MAX2.5	SPINNING
S642	1.93	1	193.0	200	60-180	MAX2.5	SPINNING
S643	1.93	1	193.0	205	80-200	MAX3	SPINNING
S644	1.93	1	193.0	215	100-240	MAX4	SPINNING
<b>QUICK JERK</b>							
S621	1.88	1	188.0	185	60-150	MAX2.5	SPINNING
S622	1.88	1	188.0	190	80-160	MAX2.5	SPINNING
S623	1.88	1	188.0	195	90-180	MAX3	SPINNING
S624	1.88	1	188.0	210	100-210	MAX4	SPINNING
S605	1.83	1	183.0	215	120-250	MAX5	SPINNING
<b>QUICK JERK (SHORT LENGTH MODEL)</b>							
SS10-3	1.78	1	178.0	180	100-280	MAX3	SPINNING
SS10-4	1.78	1	178.0	185	120-210	MAX4	SPINNING
SS10-5	1.78	1	178.0	205	140-250	MAX5	SPINNING
SS8-6	1.73	1	173.0	205	160-300	MAX6	SPINNING

Ocea Jigger (Baitcast)

The constant pursue of power resulted in the brand new Ocea Jigger Baitcast series. Experience a whole new level of responsiveness that allows easy manipulation of the jig with a quick jerk through the use of a high-dimensional blank while reducing an anglers' burden.



OCEA JIGGER							
Model Number	Rod Length [m]	No. of Sections	Closed Length [cm]	Weight [g]	Lure Weight [g]	Line Weight [PE]	Type
B60-3	1.83	1	183.0	160	80-180	MAX3	BAITCAST
B60-4	1.83	1	183.0	170	100-220	MAX4	BAITCAST
B60-5	1.83	1	183.0	180	120-300	MAX5	BAITCAST

# OCEA JIGGER

The essence of a jiggering rod lies in its operability when it comes to jerking the rod (repeated action of lifting and lowering the tip of the rod quickly).

The OCEA Jigger Infinity lineup uses full 1-piece blanks which are slender and finished with a slow taper. To those who wish to challenge the monsters in uncharted waters, the addition of these 5 reliable rods with power ratings 6 to 10 will keep you company through and through. Jump into the new realm of Slow Jiggering with the OCEA Jigger Infinity!



※1: Excluding B61-9, B61-10

OCEA JIGGER							
Model Number	Rod Length [m]	No. of Sections	Closed Length [cm]	Weight [g]	Lure Weight [g]	Line Weight [PE]	Type
B65-0	1.96	1	196.0	129	40-130	MAX1.5	BAITCAST
B65-1	1.96	1	196.0	129	80-180	MAX1.5	BAITCAST
B65-2	1.96	1	196.0	13	100-230	MAX2	BAITCAST
B65-3	1.96	1	196.0	142	120-180	MAX2.5	BAITCAST
B63-4	1.91	1	191.0	146	140-350	MAX3	BAITCAST
B63-5	1.91	1	191.0	151	160-430	MAX3	BAITCAST
B63-6	1.91	1	191.0	162	180-500	MAX4	BAITCAST
B61-7	1.85	1	185.0	169	200-600	MAX4	BAITCAST
B61-8	1.85	1	185.0	173	230-750	MAX4	BAITCAST
B61-9	1.85	1	185.0	177	260-900	MAX5	BAITCAST
B61-10	1.85	1	185.0	198	300-1200	MAX5	BAITCAST



OCEA JIGGER NATURAL JERK S643

OCEA JIGGER QUICK JERK S624

OCEA JIGGER B60-4

OCEA JIGGER B65-3

RODS

FEATURES

JIGGERING

POPPING/CASTING

BOAT GAME

BASS

GALATAMA

MULTI-PIECE SURF

TELESCOPIC SURF

SPECIAL

EGGING



OCEA JIGGER ∞ MOTIVE B610-4

OCEA JIGGER LJ B65-0/FS

OCEA JIGGER LJ B63-2

OCEA EJ B63-4

## OCEA JIGGER ∞ MOTIVE

Feel the jig with your fingertips as you manipulate it and achieve fascinating long-fall action so attractive that no fish can resist.

Semi-long 6'10" blanks eliminate power loss and enhance sensitivity with Shimano's latest rod technology: Spiral X Core. Skillfully shift between slow to medium pitch jerks of variable speeds to control the long-fall action as you please. With the newest Full Holding Seat, comfort is maximised for stress-free jigging all day.



### OCEA JIGGER INFINITY MOTIVE

Model Number	Rod Length [m]	No. of Sections	Closed Length [cm]	Weight [g]	Lure Weight [g]	Line Weight [PE]	Type
B610-0	2.08	2	161.4	115	40-130	MAX1.5	BAITCAST
B610-1	2.08	2	161.1	117	80-180	MAX1.5	BAITCAST
B610-2	2.08	2	160.8	117	100-230	MAX2	BAITCAST
B610-2+	2.08	2	161.1	120	110-270	MAX2.5	BAITCAST
B610-3	2.08	2	161.2	130	130-300	MAX2.5	BAITCAST
B610-4	2.08	2	161.2	140	160-380	MAX3	BAITCAST
B610-5	2.08	2	161.2	140	200-450	MAX3	BAITCAST
B610-6	2.08	2	161.9	148	230-500	MAX4	BAITCAST

## OCEA JIGGER LJ

A model that pursues the essence of light jigging with fine bending along the whole blank.

This is the flagship model of light jigging rods. Furthermore, the light and strong Spiral X Core blank strengthens the whole body and enables the rod to flex like a spring from the tip to the end. Ocea Jigger LJ is a full one piece structure right through to the grip.



※1 : Excluding Full Solid series ※2 : Full Solid Series

### OCEA JIGGER LJ

Model Number	Rod Length [m]	No. of Sections	Closed Length [cm]	Weight [g]	Lure Weight [g]	Line Weight [PE]	Type
<b>Full Solid (Super Light Jigging)</b>							
S65-0/FS	1.96	1	196.2		20-100	MAX1.2	SPINNING
B65-0/FS	1.96	1	196.2		30-100	MAX1.2	BAITCAST
<b>Full Solid</b>							
S62-1/FS	1.88	1	188.0		30-130	MAX1.5	SPINNING
S62-2/FS	1.88	1	188.0		40-160	MAX2	SPINNING
B62-1/FS	1.88	1	188.2		40-130	MAX1.5	BAITCAST
B62-2/FS	1.88	1	188.2		50-160	MAX2	BAITCAST
<b>Standard</b>							
B63-1	1.91	1	191.0		40-130	MAX1.5	BAITCAST
B63-2	1.91	1	191.0		50-160	MAX2	BAITCAST
B63-3	1.91	1	191.0		60-200	MAX2	BAITCAST
<b>HP</b>							
B61-1HP	1.86	1	186.0		40-130	MAX1.5	BAITCAST
B61-2HP	1.86	1	186.0		50-160	MAX2	BAITCAST

## OCEA EJ

Special Blanks Design allows the rod to withstand against fast moving targets underwater and also the powerful cranking force of the latest BeastMaster EJ.

The long front grip also enable the use of both hands during operations and fights with sea monsters!



### OCEA EJ

Model Number	Rod Length [m]	No. of Sections	Closed Length [cm]	Weight [g]	Lure Weight [g]	Line Weight [PE]	Type
B63-3	1.91	2	130	164	MAX230	MAX3	BAITCAST
B63-4	1.91	2	130	172	MAX300	MAX4	BAITCAST
B63-5	1.91	2	130	175	MAX350	MAX5	BAITCAST
B63-6	1.91	2	130	181	MAX400	MAX5	BAITCAST

# GAME Type EJ

Make electric jigging more accessible and fun!

The Game type EJ lineup allows more anglers to enjoy the real thrill of e-jigging. With powerful and high-speed retrieves unique to electric jigging, it is effective in capturing migratory fish such as blue fish and tuna. On the other hand, it also has the ability to handle slow to middle speed jerk motions. The butt of the rod is strong so it reduces the burden on the angler even when using hoisting power as strong as that from an electric reel. The rods are also not too stiff so that jigs have a natural presentation in their actions. Equipped with the Spiral X Core technology, it is highly resistant to compromising stresses such as bending, twisting, and compressions.



GAME TYPE EJ								NEW
Model Number	Rod Length [m]	No. of Sections	Closed Length [cm]	Weight [g]	Lure Weight [g]	Line Weight [PE]	Type	
B63-3	1.91	2	130.0	155	MAX230	MAX3	BAITCAST	
B63-4	1.91	2	130.0	169	MAX300	MAX4	BAITCAST	
B60-5	1.83	2	122.0	165	MAX350	MAX5	BAITCAST	
B510-6	1.78	2	119.0	167	MAX400	MAX6	BAITCAST	

# GAME Type LJ

The new Game Type LJ line up is now more comprehensive to cover all the different jigging applications for jig up to 180g.

The oversized EVA handle also allows maximum range of motion for flicking action of the jig. Lighter tip action gives maximum control over light jigs and the Spiral X Core and Hi-Power X blanks gives an extra backbone so that maximum pressure can be applied onto the fish at the end of the line.



※1 : EXCLUDING FULL SOLID SERIES ※2 : FULL SOLID SERIES

GAME TYPE LJ								
	Model Number	Rod Length [m]	No. of Sections	Closed Length [cm]	Weight [g]	Lure Weight [g]	Line Weight [PE]	Type
Full Solid Super Light Jigging	S65-00/FS	1.96	2	154.5	115	10-80	MAX1	SPINNING
	S65-0/FS	1.96	2	154.0	117	20-100	MAX1.2	SPINNING
	B65-0/FS	1.96	2	149.8	115	30-100	MAX1.2	BAITCAST
Full Solid	B62-1/FS	1.88	2	141.8	115	40-130	MAX1.5	BAITCAST
	B62-2/FS	1.88	2	141.8	120	50-160	MAX2	BAITCAST
Standard Super light Jigging	S62-0	1.88	2	144.5	TBC	20-100	MAX1.2	SPINNING
	S610-0	2.08	2	165.5	TBC	20-100	MAX1.2	SPINNING
Standard	B62-0	1.88	2	142.8	TBC	30-100	MAX1.2	BAITCAST
	S63-1	1.91	2	145.0	112	30-130	MAX1.5	SPINNING
	S63-2	1.91	2	145.0	122	40-160	MAX2	SPINNING
Standard	B63-1	1.91	2	145.8	107	40-130	MAX1.5	BAITCAST
	B63-2	1.91	2	145.8	110	50-160	MAX2	BAITCAST
	B63-3	1.91	2	145.8	112	60-180	MAX2	BAITCAST

# GAME Type J

Jerk, Power & Stress Free! Evolved form of the absolute fundamentals!

This impressive new series feature improved blank technology and offer five spin and two overhead's ranging from PE2.5 to PE8 line ratings. Improving on the original 2015 series, the 2020 series features Hi-Power X and now Shimano's patented Spiral X Core carbon construction to reduce weight and increase strength.



※1 : EXCLUDING 6~8 POWER

GAME TYPE J								
	Model Number	Rod Length [m]	No. of Sections	Closed Length [cm]	Weight [g]	Lure Weight [g]	Line Weight [PE]	Type
	S64-1	1.93	2	143.1	145	MAX150	MAX2.5	SPINNING
	S64-2	1.93	2	142.6	155	MAX160	MAX2.5	SPINNING
	S60-3	1.83	2	134.1	157	MAX180	MAX3	SPINNING
	S64-3	1.93	2	143.1	160	MAX210	MAX3	SPINNING
	S510-4	1.78	2	128.1	162	MAX210	MAX4	SPINNING
	S62-4	1.88	2	138.1	162	MAX250	MAX4	SPINNING
	S510-5	1.78	2	127.6	187	MAX300	MAX5	SPINNING
	S56-6	1.68	2	114.1	247	MAX350	MAX6	SPINNING
	S56-7	1.68	2	113.6	257	MAX350	MAX8	SPINNING
	S53-8	1.60	2	105.5	285	MAX400	MAX8	SPINNING
	B60-2	1.83	2	140.4	150	MAX160	MAX2.5	BAITCAST
	B60-3	1.83	2	141.4	155	MAX180	MAX3	BAITCAST
	B60-4	1.83	2	140.4	162	MAX210	MAX4	BAITCAST
	B60-5	1.83	2	139.4	175	MAX250	MAX5	BAITCAST
	B56-6	1.68	2	105.3	247	MAX300	MAX6	BAITCAST
	B56-7	1.68	2	104.8	260	MAX350	MAX8	BAITCAST
	B53-8	1.60	2	96.8	295	MAX400	MAX8	BAITCAST

GAME Type EJ B63-3

GAME Type LJ B63-2

GAME Type J S62-4

GAME Type J S56-6

GAME Type J S53-8

GAME Type J B60-4

# GAME Type Slow J

The strength and bend of this latest Game Type SJ model closely mimics that of a one-piece rod because of the grip joint.

Revolving around the fall action centered slow jig style, use all sorts of combination between fast and slow jerks, low and high pitch to control the speed and actions of the jigs.



### GAME TYPE SLOW J

Model Number	Rod Length [m]	No. of Sections	Closed Length [cm]	Weight [g]	Lure Weight [g]	Line Weight [PE]	Type
B66-0	1.98	2	150.2	122	MAX130	MAX1.5	BAITCAST
B66-1	1.98	2	150.2	122	MAX160	MAX1.5	BAITCAST
B66-2	1.98	2	150.2	128	MAX200	MAX2	BAITCAST
B66-3	1.98	2	150.2	132	MAX260	MAX2.5	BAITCAST
B66-4	1.98	2	150.2	139	MAX330	MAX3	BAITCAST
B66-5	1.98	2	150.2	146	MAX400	MAX3	BAITCAST
B66-6	1.98	2	150.2	157	MAX500	MAX4	BAITCAST

# GRAPPLER

Tested over and over again throughout the seas across the entire globe, the Grappler rod which anglers have been waiting anxiously for, has finally been developed.



## Type LJ ——— LIGHT JIGGING/ SUPER LIGHT JIGGING (0 POWER)

### GRAPPLER TYPE LJ

Model Number	Rod Length [m]	No. of Sections	Closed Length [cm]	Weight [g]	Lure Weight [g]	Line Weight [PE]	Type
S66-0	1.98	2	158.3	115	20-100	MAX1.2	SPINNING
S63-1	1.91	2	146.1	125	30-130	MAX1.5	SPINNING
S63-2	1.91	2	146.1	125	40-160	MAX2	SPINNING
S63-3	1.91	2	143.6	127	50-180	MAX2	SPINNING
B66-0	1.98	2	151.3	115	30-100	MAX1.2	BAITCAST
B63-1	1.91	2	144.0	112	40-130	MAX1.5	BAITCAST
B63-2	1.91	2	144.0	112	50-160	MAX2	BAITCAST
B63-3	1.91	2	144.0	115	60-180	MAX2	BAITCAST

## Type Slow J ——— SLOW JIGGING

### GRAPPLER TYPE SLOW J

Model Number	Rod Length [m]	No. of Sections	Closed Length [cm]	Weight [g]	Lure Weight [g]	Line Weight [PE]	Type
B68-1	2.03	2	156.2	110	MAX160	MAX1.5	BAITCAST
B68-2	2.03	2	156.2	115	MAX200	MAX2	BAITCAST
B68-3	2.03	2	156.2	120	MAX260	MAX2.5	BAITCAST
B68-4	2.03	2	156.2	125	MAX330	MAX3	BAITCAST
B68-5	2.03	2	156.2	135	MAX400	MAX3	BAITCAST

## Type J ——— JIGGING

### GRAPPLER TYPE J

Model Number	Rod Length [m]	No. of Sections	Closed Length [cm]	Weight [g]	Lure Weight [g]	Line Weight [PE]	Type
S60-2	1.83	2	130.7	157	MAX160	MAX2.5	SPINNING
S60-3	1.83	2	130.7	170	MAX180	MAX3	SPINNING
S60-4	1.83	2	130.2	177	MAX210	MAX4	SPINNING
S60-5	1.83	2	129.7	187	MAX250	MAX5	SPINNING
S56-6	1.68	2	112.0	255	MAX300	MAX6	SPINNING
S56-7	1.68	2	111.5070	265	MAX350	MAX8	SPINNING
S53-8	1.60	2	104.0	305	MAX400	MAX8	SPINNING
B60-2	1.83	2	138.9	137	MAX160	MAX2.5	BAITCAST
B60-3	1.83	2	138.9	140	MAX180	MAX3	BAITCAST
B60-4	1.83	2	137.9	145	MAX210	MAX4	BAITCAST
B60-5	1.83	2	136.9	152	MAX250	MAX5	BAITCAST
B56-6	1.68	2	103.3	267	MAX300	MAX6	BAITCAST
B56-7	1.68	2	102.8	275	MAX350	MAX8	BAITCAST
B53-8	1.60	2	95.3	305	MAX400	MAX8	BAITCAST

### GRAPPLER TYPE J (3-PIECE MODEL)

S60-3/3	1.83	3	69.	172	MAX180	MAX3	SPINNING
S60-4/3	1.83	3	68.8	182	MAX210	MAX4	SPINNING
S60-5/3	1.83	3	68.5	192	MAX250	MAX5	SPINNING
B60-3/3	1.83	3	73.3	142	MAX180	MAX3	BAITCAST
B60-4/3	1.83	3	73.8	150	MAX210	MAX4	BAITCAST
B60-5/3	1.83	3	73.8	170	MAX250	MAX5	BAITCAST



GAME Type Slow J B66-3

GRAPPLER TYPE J B60-4

GRAPPLER TYPE J S60-4/3

GRAPPLER TYPE J B53-8

GRAPPLER TYPE J B60-4/3

GRAPPLER TYPE LJ S63-2

GRAPPLER TYPE SLOW J B68-3

# GRAPPLER BB

Covering all areas of jigging with 22 items in the lineup. A 'global' rod catering to the whole world.

The Grappler BB is a rod you can bring across the whole world. With high cost performance, the Hi-Power X blanks eliminates any discomfort resulting from high twisting loads. This is crucial in off shore games as both power and response is improved, even when applying aggressive jigging styles or fighting larger species. Since the Grappler BB is a global rod, Shimano wanted to make it as convenient to carry around as possible, resulting in all 22 items being 2-piece rods, with a bend profile almost similar to 1-piece rods. Whether it's speed and power for jigging, or versatility in in-shore games, or the charming slow jigging which uses slow and fall actions, there is without a doubt a model for you in the Grappler BB lineup.

## Type J ————— JIGGING

GRAPPLER BB TYPE J							
Model Number	Rod Length [m]	No. of Sections	Closed Length [cm]	Weight [g]	Lure Weight [g]	Line Weight [PE]	Type
S60-2	1.83	2	131.6	160	MAX160	MAX2.5	SPINNING
S60-3	1.83	2	132.6	172	MAX180	MAX3	SPINNING
S60-4	1.83	2	132.1	185	MAX210	MAX4	SPINNING
S60-5	1.83	2	129.7	193	MAX250	MAX5	SPINNING
S56-6	1.68	2	114.1	245	MAX300	MAX6	SPINNING
B60-2	1.83	2	139.8	138	MAX160	MAX2.5	BAITCAST
B60-3	1.83	2	140.8	142	MAX180	MAX3	BAITCAST
B60-4	1.83	2	140.0	152	MAX210	MAX4	BAITCAST
B60-5	1.83	2	138.8	163	MAX250	MAX5	BAITCAST
B56-6	1.68	2	105.7	295	MAX300	MAX6	BAITCAST

## Type LJ ————— LIGHT JIGGING/ SUPER LIGHT JIGGING (0 POWER)

GRAPPLER BB TYPE LJ							
Model Number	Rod Length [m]	No. of Sections	Closed Length [cm]	Weight [g]	Lure Weight [g]	Line Weight [PE]	Type
S66-0	1.98	2	159.3	105	20-100	MAX1.2	SPINNING
S63-1	1.91	2	147.2	122	30-130	MAX1.5	SPINNING
S63-2	1.91	2	147.4	127	40-160	MAX2	SPINNING
S63-3	1.91	2	145.6	130	50-180	MAX2	SPINNING
B66-0	1.98	2	152.3	109	30-100	MAX1.2	BAITCAST
B66-1	1.91	2	145.2	112	40-130	MAX1.5	BAITCAST
B66-2	1.91	2	145.4	117	50-160	MAX2	BAITCAST
B66-3	1.91	2	145.6	123	60-200	MAX2	BAITCAST

## Type Slow J ————— SLOW JIGGING

GRAPPLER BB TYPE SLOW J							
Model Number	Rod Length [m]	No. of Sections	Closed Length [cm]	Weight [g]	Lure Weight [g]	Line Weight [PE]	Type
B66-1	1.98	2	150.2	117	MAX160	MAX1.5	BAITCAST
B66-2	1.98	2	150.2	120	MAX200	MAX2	BAITCAST
B66-3	1.98	2	150.2	125	MAX260	MAX2.5	BAITCAST
B66-4	1.98	2	150.2	130	MAX330	MAX3	BAITCAST



GRAPPLER BB TYPE J S60-4

GRAPPLER BB TYPE J B60-4

GRAPPLER BB TYPE J B56-6

GRAPPLER BB TYPE LJ S63-2

GRAPPLER BB TYPE LJ B63-2

GRAPPLER BB TYPE SLOW J B66-3



## SALTY ADVANCE

A range of rods for anglers looking to begin exploring the saltwater game!

With blanks similar to those of the BB series rods, the rods in this range are light, sharp and powerful. Unlike its predecessors, the second generation of Salty Advance rods use All K Guides to minimise troubles occurring from lines. As each and every rod in this range have been designed for specific targets, anglers are able to choose easily which rods to get depending on the target species.



※1 : S64UL-S  
※2 : S610L-S

### SALTY ADVANCE

**NEW**

Model Number	Rod Length [m]	No. of Sections	Closed Length [cm]	Weight [g]	Lure Weight [g]/ [No.]	Line Weight [PE]	Type
<b>JIGGING</b>							
B60-3	1.83	2	140.8	TBC	MAX180	MAX3	BAITCAST
B60-4	1.83	2	140.0	TBC	MAX210	MAX4	BAITCAST
S60-3	1.83	2	132.6	TBC	MAX180	MAX3	SPINNING
S60-4	1.83	2	132.1	TBC	MAX210	MAX4	SPINNING
<b>LIGHT JIGGING</b>							
B63ML	1.91	2	142.5	120	MAX160	MAX2	BAITCAST
S63ML	1.91	2	146.5	120	MAX160	MAX2	SPINNING
<b>ULTRA LIGHT JIGGING</b>							
S66UL	1.98	2	159.3	TBC	MAX100	MAX1.2	SPINNING
<b>EGING</b>							
S83ML	2.52	2	129.4	90	1.8-3.8	0.4-1	SPINNING
S86ML	2.59	2	133.2	90	1.8-3.8	0.4-1	SPINNING
S83M	2.52	2	129.4	97	2-4	0.5-1	SPINNING
S86M	2.59	2	133.2	97	2-4	0.5-1	SPINNING
<b>AJING</b>							
S64UL-S	1.93	2	99.0	65	0.3-6	0.1-0.4	SPINNING
S610L-S	2.08	2	106.5	67	0.5-12	0.1-0.6	SPINNING
<b>SHORE JIGGING</b>							
S96M	2.90	2	149.5	225	MAX60	MAX2	SPINNING
S100M	3.05	2	157.0	240	MAX60	MAX2	SPINNING
S96MH	2.90	2	149.5	247	MAX80	MAX3	SPINNING
S100MH	3.05	2	157.0	265	MAX80	MAX3	SPINNING
S100H	3.05	2	157.0	270	MAX100	MAX4	SPINNING



## OCEA PLUGGER LIMITED

When it comes to off-shore casting games, nothing is more desirable than casting distance.

The OCEA Plugger Limited focuses on just that - a rod to send jigs and lures soaring through the sky and getting that extra few meters of distance in.



OCEA PLUGGER LIMITED							
Model Number	Rod Length [m]	No. of Sections	Closed Length [cm]	Weight [g]	Lure Weight [g]	Line Weight [PE]	Type
S83M	2.53	2	185.5	335	MAX100	MAX5	SPINNING
S83MH	2.53	2	185.3	346	MAX120	MAX6	SPINNING
S710H	2.40	2	172.3	352	MAX150	MAX8	SPINNING
S83H	2.53	2	185.0	364	MAX150	MAX8	SPINNING
S88H	2.64	2	185.6	390	MAX150	MAX8	SPINNING
S82XH	2.50	2	182.4	370	MAX180	MAX10	SPINNING

## OCEA PLUGGER BG

Ocea Plugger Popping series is for the professional anglers looking for the best popping rods.

The series encompass power and workability, ensuring that angler fatigue can be properly managed throughout the fishing trip. All rods are exquisitely made with Shimano Spiral X and super reinforced with Shimano High Power X finish. To suit different type of popping there are 3 main series to choose from; Wild Response, Monster Drive and Flex for monster GT fishing to Tuna Fishing.



OCEA PLUGGER BG							
Model Number	Rod Length [m]	No. of Sections	Closed Length [cm]	Weight [g]	Lure Weight [g]	Line Weight [PE]	Type
<b>BG MONSTER DRIVE</b>							
S86H-3	2.59	3	97.0	420	MAX180	MAX8	SPINNING
S83XH-3	2.51	3	94.5	420	MAX200	MAX10	SPINNING
<b>BG FLEX ENERGY</b>							
S83H	2.51	2	179.1	403	MAX180	MAX8	SPINNING
S710XH	2.39	2	166.1	418	MAX200	MAX10	SPINNING
<b>BG BLUEFIN TUNA</b>							
S73XXH	2.22	2	148.6	448	MAX250	MAX12	SPINNING
S70XXH	2.13	2	140.6	441	MAX250	MAX12	SPINNING

## OCEA PLUGGER FLEXDRIVE

Flex and win! Rest assured when taking monsters of the sea head-on.

The OCEA PLUGGER Flex Drive focuses mainly on its butt power by incorporating a blanks with low elasticity, high rebound strength and a natural bend to the rod. This lineup of rods provides the most support during power fights as it helps you to stabilize your center of gravity, minimizing any unnecessary fatigue during these fights. The strength from the rod butt does not mean that the rod is overly stiff. Anglers get the best of both worlds with this long-distance casting rod along with its natural bend which translates to a natural presentation on swimming plugs. Shimano is honoured to be able to provide anglers with a trusty lineup which excels at sensitivity, castability, operability and power.



OCEA PLUGGER FLEXDRIVE <span style="background-color: red; color: white; padding: 2px;">NEW</span>							
Model Number	Rod Length [m]	No. of Sections	Closed Length [cm]	Weight [g]	Lure Weight [g]	Line Weight [PE]	Type
S76ML	2.29	2	174.9	TBC	MAX80	MAX4	SPINNING
S77M	2.31	2	171.2	TBC	MAX100	MAX5	SPINNING
S83M	2.51	2	187.1	TBC	MAX100	MAX5	SPINNING
S77MH	2.31	2	170.8	TBC	MAX120	MAX6	SPINNING
S83MH	2.51	2	183.9	TBC	MAX120	MAX6	SPINNING
S83H	2.51	2	183.9	TBC	MAX150	MAX8	SPINNING



OCEA PLUGGER LIMITED S83H

OCEA PLUGGER BG BLUEFIN TUNA S70XXXH

OCEA PLUGGER FLEXDRIVE S76ML

OCEA PLUGGER FULL THROTTLE S83H

COLTSNIPER XTUNE S100H

COLTSNIPER XR S100ML

COLTSNIPER XR B100H

## OCEA PLUGGER FULL THROTTLE

Shimano's flagship offshore popping and plugging rods, the Ocea Plugger Full Throttle utilize Spiral X and Hi-Power X blank construction.

The redesigned models have more powerful mid-sections than previous models and an improved cosmetic design. Shimano's patented Spiral X blank construction reduces blank twist and leads to longer, more accurate casting. Less blank twist also makes it easier to pull on big fish and takes pressure off the angler. Hi-Power X technology reduces ovalization and increases strength to protect from breakage. Spiral X combined with Hi-Power X provides anglers a series of popping and plugging rods with a best-in-class strength-to-weight ratio.



### OCEA PLUGGER FULL THROTTLE

Model Number	Rod Length [m]	No. of Sections	Closed Length [cm]	Weight [g]	Lure Weight [g]	Line Weight [PE]	Type
S74ML	2.23	2	172.1	232	20-70	MAX4	SPINNING
S77M	2.31	2	174.3	257	30-90	MAX5	SPINNING
S80M	2.43	2	182.7	280	30-100	MAX6	SPINNING
S82MH	2.48	2	181.9	332	45-120	MAX8	SPINNING
S83H	2.51	2	184.6	353	60-150	MAX8	SPINNING
S88H	2.64	2	195.1	380	60-150	MAX8	SPINNING

## COLTSNIPER XTUNE

When fishing for large contenders from the shore, it is absolutely understandable why anglers would want a rod which guarantees performance.

Introducing the latest COLTSNIPER XTUNE with an unbelievably reliable blank which is highly resistant to twisting loads. The Screw Lock Joint feature also increases the grip strength at the joint of the rod!



### COLTSNIPER XTUNE

Model Number	Rod Length [m]	No. of Sections	Closed Length [cm]	Weight [g]	Lure Weight [g]	Line Weight [PE]	Type
S100M	3.05	2	157.0	268	MAX50	MAX3	SPINNING
S100MH	3.05	2	157.0	309	MAX70	MAX4	SPINNING
S106MH/PS	3.20	2	164.5	317	MAX70	MAX4	SPINNING
S100H	3.05	2	157.0	334	MAX100	MAX5	SPINNING
S106H/PS	3.20	2	164.5	356	MAX100	MAX5	SPINNING
S100XH	3.05	2	157.0	361	MAX120	MAX6	SPINNING
S106XH/PS	3.20	2	164.5	385	MAX120	MAX6	SPINNING
S98XXH	2.95	2	152.0	369	MAX150	MAX8	SPINNING

## COLTSNIPER XR

The COLTSNIPER XR series provides balance in sharpness, power, long casting abilities and lightness, making it the perfect partner when it comes to shore jigging and plugging games.

In addition to strengthening the blanks with Spiral X Core, the sections of the rods are locked in place and separated easily with the Screw Lock Joint feature!



\*PS: Plugging Special  
※1: M L Power

### COLTSNIPER XR

**NEW**

Model Number	Rod Length [m]	No. of Sections	Closed Length [cm]	Weight [g]	Lure Weight [g]	Line Weight [PE]	Type
S96ML	2.90	2	149.5	222	MAX45	MAX2.5	SPINNING
S100ML	3.05	2	157.0	232	MAX45	MAX2.5	SPINNING
S96M	2.90	2	149.5	275	MAX56	MAX3	SPINNING
S100M	3.05	2	157.0	282	MAX56	MAX3	SPINNING
S106M/PS	3.20	2	164.3	270	MAX56	MAX3	SPINNING
S96MH	2.90	2	149.5	307	MAX70	MAX4	SPINNING
S100MH	3.05	2	157.0	313	MAX70	MAX4	SPINNING
S106MH/PS	3.20	2	164.3	306	MAX70	MAX4	SPINNING
S96H	2.90	2	149.5	315	MAX100	MAX5	SPINNING
S100H	3.05	2	157.0	330	MAX100	MAX5	SPINNING
S106H/PS	3.20	2	164.3	330	MAX100	MAX5	SPINNING
S98XH	2.95	2	151.8	327	MAX120	MAX6	SPINNING
S100MH-3	3.05	3	116.4	310	MAX70	MAX4	SPINNING
S100H-3	3.05	3	116.4	317	MAX100	MAX5	SPINNING
S100XH-3	3.05	3	116.4	335	MAX120	MAX6	SPINNING
B100M	3.05	2	157.1	290	MAX56	MAX3	BAITCAST
B100MH	3.05	2	157.1	307	MAX70	MAX4	BAITCAST
B100H	3.05	2	157.1	315	MAX100	MAX5	BAITCAST

# COLTSNIPER SS

The COLTSNIPER SS introduces standard rod models performing fantastically in Shore Jigging and Plugging scenes. With significant improvements in long casts and power, bring these rods to beaches, shores and rock-fishing spots to feel the upgrade in your hands.

Long casts or powerful fights, these rods help preserve stamina due to their light weight cultivated from weight-reducing efforts such as the separate grip feature.



COLTSNIPER SS							
Model Number	Rod Length [m]	No. of Sections	Closed Length [cm]	Weight [g]	Lure Weight [g]	Line Weight [PE]	Type
S96M	2.90	2	149.5	225	MAX60	MAX2.5	SPINNING
S100M	3.05	2	157.0	240	MAX60	MAX2.5	SPINNING
S106M	3.20	2	164.0	245	MAX60	MAX2.5	SPINNING
S96MH	2.90	2	149.5	248	MAX80	MAX3	SPINNING
S100MH	3.05	2	157.0	260	MAX80	MAX3	SPINNING
S106MH	3.20	2	164.0	265	MAX80	MAX3	SPINNING
S96H	2.90	2	149.5	270	MAX100	MAX4	SPINNING
S100H	3.05	2	157.0	280	MAX100	MAX4	SPINNING
S106H	3.20	2	164.0	285	MAX100	MAX4	SPINNING
TELESCOPIC							
S100M-T	3.05	3	117.6	255	MAX45	MAX2.5	SPINNING
S100MH-T	3.05	3	117.6	288	MAX65	MAX3	SPINNING

# COLTSNIPER BB

A basic model with an upgrade in swinging power.

The Coltsniper BB boasts high resistance against twisting loads with the Hi-Power X structure. It provides you with the fundamentals any angler would need for shore jigging - casting distance, power and ease to use. Choose anywhere from ML power rating for various light jigs to M and H power ratings for big plugs and heavy weight jigs. The Coltsniper BB is a highly performing rod with even the convenient 3-piece rods included in the latest lineup.



COLTSNIPER BB <span style="float: right;">NEW</span>							
Model Number	Rod Length [m]	No. of Sections	Closed Length [cm]	Weight [g]	Lure Weight [g]	Line Weight [PE]	Type
S96ML	2.90	2	149.3	233	MAX50	MAX2	SPINNING
S100ML	3.05	2	157.0	244	MAX50	MAX2	SPINNING
S96M	2.90	2	149.3	253	MAX60	MAX2.5	SPINNING
S100M	3.05	2	157.0	266	MAX60	MAX2.5	SPINNING
S100M-3	3.05	3	109.7	262	MAX60	MAX2.5	SPINNING
S106M	3.20	2	164.4	276	MAX60	MAX2.5	SPINNING
S96MH	2.90	2	149.3	280	MAX80	MAX3	SPINNING
S100MH	3.05	2	157.0	293	MAX80	MAX3	SPINNING
S100MH-3	3.05	3	109.7	290	MAX80	MAX3	SPINNING
S106MH	3.20	2	164.4	309	MAX80	MAX3	SPINNING
S96H	2.90	2	149.3	294	MAX100	MAX4	SPINNING
S100H	3.05	2	157.0	307	MAX100	MAX4	SPINNING
S100H-3	3.05	3	109.7	300	MAX100	MAX4	SPINNING
TELESCOPIC							
100M-T	3.05	3	116.5	TBC	MAX45	MAX2.5	SPINNING
100MH-T	3.05	3	116.5	TBC	MAX65	MAX3	SPINNING



COLTSNIPER SS S100H

COLTSNIPER SS S100MH-T

COLTSNIPER BB S100MH



GRAPPLER Type C S82H

GRAPPLER Type C BAIT CASTING B70L

GRAPPLER Type C BAIT CASTING B710ML

GRAPPLER Type C BAIT CASTING B80M

# GRAPPLER

## Type C CASTING

For rods with actions L and ML, stainless steel framed K-guides are used while double-footed MN guides are used for rods with actions M through XH for higher strength and rigidity.



### GRAPPLER TYPE C

Model Number	Rod Length [m]	No. of Sections	Closed Length [cm]	Weight [g]	Lure Weight [g]	Line Weight [PE]	Type
S70L	2.13	2	167.7	187	MAX60	MAX2.5	SPINNING
S73ML	2.21	2	169.6	209	MAX80	MAX3	SPINNING
S710ML	2.39	2	182.2	238	MAX80	MAX4	SPINNING
S77M	2.31	2	174.2	238	MAX100	MAX5	SPINNING
S80M	2.44	2	182.9	256	MAX100	MAX5	SPINNING
S77MH	2.31	2	169.9	315	MAX120	MAX6	SPINNING
S82MH	2.49	2	181.9	340	MAX120	MAX6	SPINNING
S82H	2.49	2	181.9	365	MAX150	MAX8	SPINNING
S82XH	2.49	2	181.9	380	MAX180	MAX10	SPINNING

### GRAPPLER TYPE C (3-PIECE MODEL)

S80M-3	2.44	3	87.5	239	MAX100	MAX5	SPINNING
S82MH-3	2.49	3	89.0	332	MAX120	MAX6	SPINNING
S82H-3	2.49	3	89.0	350	MAX150	MAX8	SPINNING
S82XH-3	2.49	3	89.0	362	MAX180	MAX10	SPINNING

## GRAPPLER Type C [BAIT CASTING]

The baitcast version of shore jigging increases the accuracy of casts with a linear line outlay. Anglers can accurately shoot the lure at the tide or drop jigs in sea pockets and instantly shift to the retrieve mode.



### GRAPPLER TYPE C [BAITCASTING]

Model Number	Rod Length [m]	No. of Sections	Closed Length [cm]	Weight [g]	Lure Weight [g]	Line Weight [PE]	Type
B70L	2.13	2	167.7	194	MAX60	MAX3	BAITCAST
B73ML	2.21	2	169.6	215	MAX80	MAX4	BAITCAST
B710ML	2.39	2	182.2	242	MAX80	MAX4	BAITCAST
B80M	2.44	2	182.9	258	MAX100	MAX5	BAITCAST

**NEW**



GRAPPLER BB TypeC S70L

MOON SHOT S96M

## GRAPPLER BB Type C

Bringing the thrill of offshore casting to even more anglers through this lineup of rods with full-scale specifications.

Type C, a casting model, is now available on the highly performing Grappler BB rod developed exclusively for offshore games. As with the jigging models, the blanks that use the reinforced structure Hi-Power X, suppresses unpleasant play when a larger load is applied, making for a highly responsive and powerful rod.

Launch full-scale casts and challenge the power fighters of the sea knowing you have the support of the Grappler BB. Do not be intimidated by this rod. Although it sounds technical and might be for the intermediate anglers, the Grappler BB rods are perfect for off-shore beginners to step up their games from shore-casting games!

The lineup is completed with a total of 6 spinning models including in-shore technical models S70L, S73ML, S710ML, S80M, and power models S82MH and S82H for larger species such as tuna and yellowfins. From inshore games that make heavy use of lightweight lures to expeditions and big games, there's definitely a rod for you in this comprehensive lineup!



GRAPPLER BB TYPE C							NEW
Model Number	Rod Length [m]	No. of Sections	Closed Length [cm]	Weight [g]	Lure Weight [g]	Line Weight [PE]	Type
S70L	2.13	2	167.7	186	MAX60	MAX2.5	SPINNING
S73ML	2.21	2	169.6	206	MAX80	MAX3	SPINNING
S710ML	2.39	2	182.2	232	MAX80	MAX4	SPINNING
S80M	2.44	2	182.9	254	MAX100	MAX5	SPINNING
S82MH	2.49	2	181.9	324	MAX120	MAX6	SPINNING
S82H	2.49	2	181.9	350	MAX150	MAX8	SPINNING

## MOON SHOT

Low on price does not mean low on features. Moonshot is a rod that punches above its weight.

Dynamic Shimano "High Power X" process creates a strong and durable rod. Equipped with Fuji SiC K type guides and Shimano original reel seat, this is a rod catered to anglers of all level.



MOON SHOT							
Model Number	Rod Length [m]	No. of Sections	Closed Length [cm]	Weight [g]	Lure Weight [g]	Line Weight [PE]	Type
S90L	2.75	2	141.1	130	MAX28	0.4-1.2	SPINNING
S86ML	2.59	2	133.4	133	MAX38	0.6-1.5	SPINNING
S90ML	2.75	2	141.1	136	MAX38	0.6-1.5	SPINNING
S96ML	2.90	2	148.7	151	MAX38	0.6-1.5	SPINNING
S100ML	3.05	2	156.0	160	MAX38	0.6-1.5	SPINNING
S96M	2.90	2	148.7	156	MAX50	0.8-2	SPINNING
S100M	3.05	2	156.0	166	MAX50	0.8-2	SPINNING
S106M	3.20	2	163.6	183	MAX50	0.8-2	SPINNING
S110M	3.35	2	172.1	190	MAX50	0.8-2	SPINNING
S96MH	2.90	2	148.7	180	MAX60	1-2.5	SPINNING
S100MH	3.05	2	156.0	185	MAX60	1-2.5	SPINNING
S106MH	3.20	2	163.6	187	MAX60	1-2.5	SPINNING



Chermare BG H165

ARCIERA KIHADA 190

## Chermare **BG**

Pursuing the strongest in the history of tubular boat rods.

The blank is made with UD glass as the main material while carbon is incorporated into the design from the backbone to the butt. The blank which forms the basis of a rod is improved with both the Spiral X and Hi Power X structure, resulting in an extremely high resistance against torsional loads. This rod has a well balanced tip which allows anglers to feel the slightest change of underwater activity but at the same time, does not scare the target off while taking the bait. With the strength to fight diving monsters, this rod is a partner most sought after by anglers which love the big game.



※1:MH205

M165, H165

1 PIECE

M165, MH205

6:4 ACTION

MH205

2-PIECE DETACHABLE BUTT

H165

7:3 ACTION

### CHERMARE BG

Model Number	Rod Length [m]	No. of Sections	Closed Length [cm]	Weight [g]	Sinker Weight [No.]
M165	1.65	1	165.0	480	60-250
MH205	2.05	2	172.4	545	60-300
H165	1.65	1	165.0	480	60-300

## BeastMaster KIHADA

BeastMaster KIHADA was born, pursuing true strength. A supple, tenacious, high strength with High Power X structure combined in the design.

High Power X significantly increased the torsional rigidity and torsional strength and at the same time it has the power to catch large runs securely. The high-strength parts that had been selectively chosen were hardened and finished in a single piece that makes BeastMaster Kihada the best electric fishing rod without question.



ONE PIECE 6:4 ACTION

### BEASTMASTER KIHADA

NEW

Model Number	Rod Length [m]	No. of Sections	Closed Length [cm]	Weight [g]	Sinker Weight [No.]
180	1.80	1	180.0	TBC	80-400

## ARCIERA KIHADA

The blank of the rod is formed with the Spiral X technology which gives the rod its strong core. However, the strongest rod has to be better.

Reinforced with a thick carbon tape tightly wrapped around the blank in the pattern of the letter 'X', this rod is able to overwhelm even the largest of monsters on the run. In addition to being highly resistant to torsional loads, the ARCIERA KIHADA is also highly responsive. With a well balanced tip to convey information to anglers without scaring off the target, and a mid section which provides a cushioning effect to prevent leader line breaks, this rod comes with a butt power capable of withstanding even aggressive electric pumping motions. The whole concept of the ARCIERA KIHADA is "Reeling in large monsters with ease and comfort."



1 PIECE 7:3 ACTION

### ARCIERA KIHADA

Model Number	Rod Length [m]	No. of Sections	Closed Length [cm]	Weight [g]	Sinker Weight [No.]
170	1.70	1	170.0	535	80-400
190	1.90	1	190.0	545	80-400

## ARCIERA BG

A standing rod with traits inherited from the Chermare series.

The main component of the blanks is the UD material which makes it supple yet highly rebounding. This carbon-based UD material is light yet strong to complement the structural technologies (Spiral X Core & Hi-Power X). The soft and supple tip of the rod helps to convey accurately the movement of the bait while the strong butt (with ferrule) of the rod is strong and sturdy to keep you assured that it will conquer any fish in any of your standing fights!



※1:MH180,H175

M135

1 PIECE

M135, MH180

6:4 ACTION

MH180, H175

2-PIECE DETACHABLE BUTT

H175

7:3 ACTION

### ARCIERA BG

Model Number	Rod Length [m]	No. of Sections	Closed Length [cm]	Weight [g]	Sinker Weight [No.]
M135	1.35	1	134.8	440	30-200
MH180	1.80	2	149.0	524	60-250
H175	1.75	2	144.0	524	60-300

## ARCIERA OTOSHIKOMI

A soft tip on tough reliable blanks.

The main blanks is made of a composite comprising of the supple yet highly rebounding UD glass and the light yet strong carbon materials, finished off with the Spiral X Core and Hi-Power X blanks technology. The Tough Butt Ferrule structure where the blanks penetrates into the inner parts of the reel seat, makes the rod extremely sensitive to change in underwater conditions. The soft tip allows live baits to swim freely while the rod butt reassures you of the rod's hooking performance, stopping the divers (fish) in their tracks. Arciera Otoshikomi really is the rod with the exact actions anglers look for in bottom fishing.



2-PIECE DETACHABLE BUTT 7:3 ACTION

### ARCIERA OTOSHIKOMI

Model Number	Rod Length [m]	No. of Sections	Closed Length [cm]	Weight [g]	Sinker Weight [No.]
M225	2.25	2	196.0	505	40-150
MH240	2.40	2	210.9	545	60-180
H230	2.30	2	200.9	570	80-200

## DEEP SOLDIER

Blanks have tightened UD glasses, the main material, with the further evolved Spiral X Core and are equipped with a strong muscle force to overcome high-load cranking.

Responding to excesses when pulling up large fish, Hi-Power X has thick carbon tape to the tip for best effect. By utilising Excite Top, the rod gives increased hand and eye sensitivity.

205 0

2-PIECE DETACHABLE BUTT 6:4 ACTION

6: 4 ratio for medium to deep light. Mainly used for No. 120-250 Weights are assumed. The rear grip is a semi-long specification that can be held by hand.

205 I

2-PIECE DETACHABLE BUTT 6:4 ACTION

6: 4 ratio with kinme as the main target. Weights 250-400 are mainly used. It is a short bat specification that supports a standing rod.

205 II

2-PIECE DETACHABLE BUTT 7:3 ACTION

7: 3 tone supports up to full-scale Kinme. With the bat power that carries the Max 600 weight, it is an item for deep fields that can be rooted. It is a short bat specification that supports a standing rod.



### DEEP SOLDIER

Model Number	Rod Length [m]	No. of Sections	Closed Length [cm]	Weight [g]	Sinker Weight [No.]
205 0	173.2	2	100-300	550	100-300
205 I	179.5	2	200-500	610	200-500
205 II	179.5	2	250-600	655	250-600

DEEP CHASER 200-200

BANDIT KIHADA 170

DEPTH HUNTER

SPEEDMASTER BOAT 1500

## DEEP CHASER

Fishing the deep reefs is becoming more popular each season and the Deep Chaser series has a couple of purpose built rods for Shimano's medium size electric reels.

The Deep Chasers possess a specialised action and guide arrangement that provides superior bite detection, but also the strength required to retrieve fish from down deep. The blanks are further reinforced by Shimano's Spiral X Core rod technology to remove twist and increase performance.



※1: 150-195, 200-200

2-PIECE DETACHABLE BUTT 7:3 ACTION

DEEP CHASER					
Model Number	Rod Length [m]	No. of Sections	Closed Length [cm]	Weight [g]	Sinker Weight [No.]
150-195	1.95	2	151.1	250	80-250
200-200	2.00	2	161.5	290	100-300
300-205	2.05	2	179.4	550	200-500

## BANDIT KIHADA

An action which boasts lifting power to challenge even the larger sizes of Yellowfins out there.

With the blanks being made with carbon and UD material using the Spiral X Core technology, you get a blanks which is highly sensitive and responsive while at the same time, being super resistant to twisting loads. The Bandit Kihada has been fine tuned from tip to butt for optimal rebound and fighting strength. All these improvements is to make sure that you can cut the distance with the fish efficiently and stop them from dashing away underwater. An exciting standing rod to face any large species underwater.



2-PIECE DETACHABLE BUTT  
170 7:3 ACTION 190 6:4 ACTION

DEEP CHASER					
Model Number	Rod Length [m]	No. of Sections	Closed Length [cm]	Weight [g]	Sinker Weight [No.]
170	1.71	2	139.1	345	80-400
190	1.91	2	159.1	365	80-400

## DEPTH-HUNTER

Introducing Depth Hunter which is fully equipped with the latest technology - Spiral X and Hi-Power X; bringing you next level performance!

Designed with a 6:4 action, this rod is perfect for live bait fishing. The soft taper allows for a more natural presentation of bait as the rod will gently lift and drop with the current. With UD GLASS construction, the rod is definitely set to withstand any abuse sent in its way!



ONE PIECE 6:4 ACTION

DEEP CHASER					
Model Number	Rod Length [m]	No. of Sections	Closed Length [cm]	Weight [g]	Sinker Weight [No.]
135L	1.35	1	135.0	380	30-200
165L	1.65	1	165.0	440	60-250
165MH	1.65	1	165.0	450	60-300

## SpeedMaster BOAT

Extremely durable and strong!

SpeedMaster Boat is developed for heavy duty bottom fishing. It comes with swivel style roller top guide, Fuji DPS seat and durable ergonomic EVA fighting grip for comfort.

SPEEDMASTER BOAT				
Model Number	Rod Length [m]	No. of Sections	Closed Length [cm]	Sinker Weight [g]
1000	2.05	2	148.5	MAX1500
1500	2.19	2	162.5	MAX1500





EXAGE BOTTOMSHIP



EXAGE BOTTOMSHIP

## EXAGE *Bottomship*

This is a versatile saltwater rod with very attractive customised styling, using high quality kevlar material and cross carbon taping. The EVA grip is also ergonomic for comfortable fishing.

EXAGE BOTTOMSHIP					
Model Number	Rod Length [m]	No. of Sections	Lure Weight [g]	Line Weight [PE]	Type
S603	6'	2	MAX150	1-3	SPINNING
S584	5'8"	2	MAX180	2-4	SPINNING
S566	5'6"	2	MAX250	4-6	SPINNING
B633	6'3"	2	MAX150	1-3	BAITCAST
B634	6'3"	2	MAX180	2-4	BAITCAST



CATANA AX TROLLING

## CATANA AX Trolling

The Catana AX Trolling benefits from a deep progressive action and strong heavy duty guides, making it more than up to the challenge of taming large pelagic species.

There is more than enough power through the blank to make sure you are always in control. The Catana also features under wrapped guides to secure them in place and a multiplier aluminium reel seat. This range has all you need to catch the biggest fish.

CATANA AX TROLLING						
Model Number	Rod Length [m]	No. of Sections	Closed Length [cm]	Weight [g]	Sinker Weight [No.]	No. of Guides
CATAXTRL12	2.13	2	1.76	578	12	8
CATAXTRL20	2.13	2	1.76	593	20	8
CATAXTRL30	2.13	2	1.76	586	30	7
CATAXTRL50	2.13	2	1.76	654	50	7



CATANA CX TROLLING LITE

## CATANA CX Trolling Lite

This is the ideal live baiting rod to catch pelagic species. The rod is a little longer than a traditional trolling rod to make it easier to fish from smaller boats with outboard engines.

There is more than enough power through the blank to make sure you are always in control. The Catana also features under wrapped guides to secure them in place and a multiplier aluminium reel seat. This range has all you need to catch the biggest fish.

CATANA CX TROLLING LITE						
Model Number	Rod Length [m]	No. of Sections	Closed Length [cm]	Weight [g]	Sinker Weight [No.]	No. of Guides
CATCXTRLL6	2.19	2	1.78	536	6	10
CATCXTRLL12	2.19	2	1.78	536	12	10
CATCXTRLL16	2.19	2	1.78	587	16	9
CATCXTRLL20	2.19	2	1.78	591	20	9



VENGEANCE TROLLING

## VENGEANCE

With a remarkable combination of performance and value, the Vengeance uses XT30 + Geofibre blanks for strength.

Perfect for anglers new to trolling from a small boat fishing for small coral species, the range has four models from a lightweight 12lb up to a powerful 50lb model that's suitable for live bait trolling and drifting.

VENGEANCE						
Model Number	Rod Length [m]	No. of Sections	Closed Length [cm]	Weight [g]	Sinker Weight [No.]	No. of Guides
VTRL12	2.05	1	205.0	530	12	8
VTRL20	2.05	1	205.0	550	20	8
VTRL30	2.05	1	205.0	600	30	7
VTRL50	2.05	1	205.0	633	50	7



A scenic view of a river with a yellow kayak in the foreground and a forested background. The text "BASS FISHING" is overlaid in the center.

# BASS FISHING

# POISON ULTIMA

JACKALL × SHIMANO

CROSSOVER Re-EVOLUTION

One of Shimano's flagship models, the Poison Ultima is constantly on its own, walking the path of evolution towards its ultimate form. A highly sturdy yet light core rod equipped with the Spiral X Core technology.



※1: EXCLUDING 162L-S, 163MH, 166M, 170M, 174MH-G  
 ※2: 162L-S, 163MH, 166M, 170M, 174MH-G ※3: 1610M, 170MH, 264UL/M, 264UL-S, 2610L-S  
 ※4: 1610L-BFS, 1610M, 1611ML+, 170MH, 172H ※5: EXCLUDING 1610L-BFS, 1610M, 1611ML+, 170MH, 172H ※6: SPINNING ※7: EXCLUDING 162L-S ※8: 264UL-S ※9: 170M  
 ※10: 162L-S ※11: 264UL-S, 2610L-S

## POISON ULTIMA

NEW

Model Number	Rod Length [m]	No. of Sections	Closed Length [cm]	Weight [g]	Lure Weight [g]	Line Weight [lb]	Type
162L-S	1.88	1	188.0	85	3.5-10	6-12	BAITCAST
163MH	1.91	1	191.0	85	10-30	10-20	BAITCAST
166M	1.98	1	198.0	97	7-21	8-16	BAITCAST
1610L-BFS	2.08	1	208.0	85	3.5-10	6-12	BAITCAST
1610M	2.08	1	208.0	TBC	7-21	8-16	BAITCAST
1611ML+	2.11	2	180.5	110	5-21	7-16	BAITCAST
170M	2.13	2	183.3	105	7-21	8-16	BAITCAST
170MH	2.13	1	213.0	TBC	10-30	10-20	BAITCAST
172H	2.18	2	186.5	120	12-42	12-25	BAITCAST
174MH-G	2.24	2	191.7	112	10-35	10-20	BAITCAST
2511UL	1.80	1	180.0	TBC	2-7	2.5-5	SPINNING
264UL/M	1.93	1	193.0	82	2-15	1.5-8	SPINNING
264UL-S	1.93	1	193.0	TBC	1.5-6	2-4	SPINNING
2610L-S	2.08	1	208.0	80	2-7	2.5-5	SPINNING

## POISON ULTIMA 5-PIECE

The Poison Ultima is a 5-piece model with the shape and sensitivity of the ultimate bass rod. From tip, to the butt to the grip, this multi piece rod performs as if it was a one-piece rod with minimum overlapping of sections at each joint. The Step Length Design gives the rods a natural bend while displaying a sharp reflex in the tip.



※1: 166L-BFS/5, 174MH+5, 266L-5 ※2: SPINNING ※3: BAITCAST

## POISON ULTIMA 5-PIECE

Model Number	Rod Length [m]	No. of Sections	Closed Length [cm]	Weight [g]	Lure Weight [g]	Line Weight [lb]	Type
166-BFS/5	1.98	5	47.4	90	3.5-10	6-12	BAITCAST
1610M-5	2.08	5	49.2	102	7-21	8-16	BAITCAST
1610MH-5	2.08	5	49.0	107	10-30	10-20	BAITCAST
174MH+5	2.24	5	52.7	122	10-42	10-20	BAITCAST
266L-5	1.98	5	48.0	77	3-10	3-6	SPINNING



POISON ULTIMA 266L-5

JACKALL × SHIMANO

CROSSOVER Re-EVOLUTION



# POISON GLORIOUS

Offering anglers the third generation of Glorious - the true "fighting rod".

Poison Glorious was designed to win under the extremely harsh conditions of the world of tournaments. It has since evolved into its third generation. This model of the racing rod analyzes not only the top tournament scene but also the characteristics of local fields nationwide, clearing the field for a newly established standard. Poison Glorious - the birth of a new era of "winning rods".



※1:267UL+, 268UL/ML-G ※2:161L-BFS, 164MH, 166L+-BFS, 170H  
 ※3:166M, 168M+, 1610M, 1610MH, 1611ML/H, 174MH+, & SPINNING ※4:EXCLUDING SOLID MODELS  
 ※5:267L+ ※6:2610L-S ※7:2510UL-S

POISON GLORIOUS <b>NEW</b>							
Model Number	Rod Length [m]	No. of Sections	Closed Length [cm]	Weight [g]	Lure Weight [g]	Line Weight [PE]	Type
161L-BFS	1.85	1	185.0	82	3.5-10	MAX1.5	BAITCAST
164MH	1.93	1	193.0	95	10-30	MAX4	BAITCAST
165MH-SB	1.96	1	196.0	TBC	10-56	MAX4	BAITCAST
165XH-SB	1.96	1	196.0	125	MAX150	MAX6	BAITCAST
166L+-BFS	1.98	1	198.0	TBC	3.5-14	MAX1.5	BAITCAST
166M	1.98	1	198.0	90	7-21	MAX3	BAITCAST
168ML+	2.03	2	174.4	TBC	5-21	MAX2	BAITCAST
1610M	2.08	2	179.1	95	7-21	MAX3	BAITCAST
1610MH	2.08	2	178.6	100	10-30	MAX4	BAITCAST
1611ML/H	2.11	2	180.8	TBC	5-42	MAX2	BAITCAST
170H	2.13	2	181.7	115	14-42	MAX5	BAITCAST
174MH+	2.24	2	192.1	105	10-42	MAX4	BAITCAST
174XH-SB	2.24	2	189.5	TBC	MAX150	MAX6	BAITCAST
2510UL	1.78	1	178.0	77	2-7	MAX0.8	SPINNING
2510UL-S	1.78	1	178.0	TBC	1.5-6	2-4	SPINNING
263ML	1.91	1	191.0	82	4-12	MAX1.2	SPINNING
266L	1.98	1	198.0	80	3-10	MAX1	SPINNING
267UL+	2.01	2	177.6	80	2-10	MAX0.8	SPINNING
267L+	2.01	2	177.6	85	3-12	MAX1	SPINNING
268UL/ML-G	2.03	2	179.4	87	2-15	MAX0.8	SPINNING
268M+	2.03	2	177.1	95	5-21	MAX1.5	SPINNING
2610UL/M	2.08	2	182.6	TBC	2-15	MAX0.8	SPINNING
2610L/MH	2.08	2	182.1	95	3-21	MAX1	SPINNING
2610L-S	2.08	2	181.1	85	2-7	MAX0.8	SPINNING
2610L/M/H	2.08	2	181.8	TBC	4-30	MAX1.2	SPINNING

# POISON GLORIOUS XC

Another Glorious gift for crankbait fans. A discerning glass composite model with the Ultimate Blanks Design.

POISON GLORIOUS XC							
Model Number	Rod Length [m]	No. of Sections	Closed Length [cm]	Weight [g]	Lure Weight [g]	Line Weight [PE]	Type
166LG/BFS	1.98	2	170.6	3.5-12	6-12	BAITCAST	BAITCAST
1610ML-G	2.08	2	177.6	5-18	7-14	BAITCAST	BAITCAST
170M-G	2.13	2	181.1	7-28	8-16	BAITCAST	BAITCAST
173MH-G	2.21	2	187.6	10-35	10-20	BAITCAST	BAITCAST



※G= REPRESENTS GLASS COMPOSITE  
 ※THE NUMBER 2 IN THE ONE PIECE SERIES REPRESENTS A "GRIP JOINT" WITH A REMOVABLE GRIP.

# POISON ADRENA

Equipped with the latest technology - Full Carbon Monocoque Grip. Experience the sensitivity and lightness never seen before on previous Adrena models.



※1: EXCLUDING SOLID MODELS ※2: 261 SUL-S, 265UL-S

POISON GLORIOUS							
Model Number	Rod Length [m]	No. of Sections	Closed Length [cm]	Weight [g]	Lure Weight [g]	Line Weight [lb]	Type
163L-BFS	1.91	1	191.0	95	4-12	6-12	BAITCAST
163ML	1.91	1	191.0	92	5-15	7-14	BAITCAST
163M	1.91	1	191.0	95	7-21	8-16	BAITCAST
166ML-G	1.98	1	198.0	105	5-18	7-14	BAITCAST
166MH	1.98	1	198.0	102	10-30	10-20	BAITCAST
166H	1.98	1	198.0	105	12-42	12-25	BAITCAST
166H-SB	1.98	1	198.0	107	10-56	12-25	BAITCAST
167L-BFS	2.01	1	201.0	95	4-12	6-12	BAITCAST
1610M-G	2.08	1	208.0	115	7-28	8-16	BAITCAST
1610M	2.08	1	208.0	105	7-21	8-16	BAITCAST
1611M+	2.11	2	180.2	110	7-28	8-20	BAITCAST
172M	2.18	2	187.5	115	7-21	6-16	BAITCAST
172H	2.18	2	186.2	122	12-42	12-25	BAITCAST
173MH	2.21	2	189.2	115	10-30	10-20	BAITCAST
174H-LM	2.24	2	190.2	130	10-56	12-25	BAITCAST
2510UL	1.78	1	178.0	82	2-7	2.5-5	SPINNING
261SUL-S	1.85	1	185.0	82	1-5	2.4	SPINNING
264UL	1.93	1	193.0	85	2-7	2.5-5	SPINNING
265UL-S	1.96	1	196.0	87	1.5-6	2.5-5	SPINNING
266L	1.98	1	198.0	87	3-10	3-6	SPINNING
267ML	2.01	1	201.0	92	4-12	4-8	SPINNING
268UL	2.03	1	203.0	85	2-7	2.5-5	SPINNING
2610UL/M	2.08	1	208.0	90	2-15	1.5-8	SPINNING
2611MH	2.11	2	181.6	105	7-21	6-12	SPINNING



※1: 265UL-S/2

POISON ADRENA 2-PIECE CENTRE CUT							
Model Number	Rod Length [m]	No. of Sections	Closed Length [cm]	Weight [g]	Lure Weight [g]	Line Weight [lb]	Type
163L-BFS/2	1.91	2	98.0	95	4-12	6-12	BAITCAST
166ML-2	1.98	2	101.5	97	5-15	7-14	BAITCAST
166M-2	1.98	2	101.5	105	7-21	6-16	BAITCAST
169XH-SB/2	2.06	2	106.2	130	MAX150	14-30	BAITCAST
1610M-2	2.08	2	106.5	107	7-21	8-16	BAITCAST
1610MH-2	2.08	2	106.5	115	10-30	10-20	BAITCAST
172H-2	2.18	2	111.5	117	12-42	12-25	BAITCAST
173MH-2	2.21	2	113.0	117	10-30	10-20	BAITCAST
264UL-2	1.93	2	99.0	82	2-7	2.5-5	SPINNING
265UL-S/2	1.96	2	100.5	85	1.5-6	2.5-5	SPINNING
266L-2	1.98	2	101.5	85	3-10	3-6	SPINNING
2610UL/M-2	2.08	2	106.5	90	2-15	1.5-8	SPINNING
276M-2	2.29	2	117.7	102	5-15	5-10	SPINNING



## WORLD SHAULA

The 'RED' assault cannot be stopped. Crystallizing the experiences of anglers from not only Japan but also across the globe, the WORLD SHAULA is a versatile partner which brings you a whole new experience!



※1 : 1702R-2, 1703R-2, 1704R-2, 1785RS-2, 17114R-2  
 ※2 : 2701FF-2, 2702R-2, 2704RS-2, 2750FF-2, 2752R-2, 2831R-2, 2832RS-2, 2833RS-2

WORLD SHAULA								NEW
Model Number	Rod Length [m]	No. of Sections	Closed Length [cm]	Weight [g]	Lure Weight [g]	Line Weight [PE]	Type	
1581F-3	1.73	3	130.0	110	5-20	MAX1.5	BAITCAST	
15101F-3	1.78	3	130.0	110	5-20	MAX1.5	BAITCAST	
15102R-3	1.77	3	130.0	115	7-28	MAX2	BAITCAST	
15103RS-3	1.78	3	130.0	110	10-40	MAX3	BAITCAST	
16005S-3	1.83	3	130.0	105	3.5-14	MAX2	BAITCAST	
16025S-3	1.82	3	130.0	122	7-30	MAX4	BAITCAST	
16045S-3	1.83	3	130.0	140	15-80	MAX6	BAITCAST	
1651FF-3	1.98	3	130.0	115	4-16	MAX1.5	BAITCAST	
1652R-3	1.98	3	130.0	115	7-28	MAX2	BAITCAST	
1653R-3	1.98	3	130.0	127	10-40	MAX3	BAITCAST	
1702R-2	2.13	2	130.0	150	7-28	MAX2	BAITCAST	
1703R-2	2.13	2	130.0	157	10-40	MAX3	BAITCAST	
1704R-2	2.13	2	130.0	157	15-80	MAX4	BAITCAST	
1754R-2	2.29	2	130.0	145	15-80	MAX4	BAITCAST	
1785RS-2	2.34	2	130.0	180	15-140	MAX6	BAITCAST	
17114R-2	2.41	2	130.0	160	15-80	MAX4	BAITCAST	
1832R-2	2.51	2	130.0	152	7-30	MAX2	BAITCAST	
1833RS-2	2.52	2	130.0	155	10-45	MAX3	BAITCAST	
2651F-3	1.98	3	130.0	107	5-15	MAX1.2	SPINNING	
2652R-3	1.98	3	130.0	110	7-20	MAX1.5	SPINNING	
2653R-3	1.98	3	130.0	120	10-30	MAX2.5	SPINNING	
2701FF-2	2.13	2	130.0	100	4-14	MAX1	SPINNING	
2702R-2	2.13	2	130.0	100	7-20	MAX1.5	SPINNING	
2704RS-2	2.13	2	130.0	125	15-80	MAX4	SPINNING	
2750FF-2	2.29	2	130.0	97	2-8	MAX0.8	SPINNING	
2752R-2	2.29	2	130.0	110	7-20	MAX1.5	SPINNING	
2831R-2	2.51	2	130.0	117	5-15	MAX1.2	SPINNING	
2832RS-2	2.51	2	130.0	125	7-30	MAX2	SPINNING	
2833RS-2	2.51	2	130.0	135	10-50	MAX3	SPINNING	

## WORLD SHAULA DREAM TOUR EDITION

Dream Tour Edition that connects great dreams. A lineup of carefully selected necessary items to fight game fish from all over the world.



WORLD SHAULA DREAM TOUR EDITION								NEW
Model Number	Rod Length [m]	No. of Sections	Closed Length [cm]	Weight [g]	Lure Weight [g]	Line Weight [PE]	Type	
1602RS-5	1.83	5	42.7	117	7-28	MAX2	BAITCAST	
1603RS-5	1.82	5	42.4	117	10-40	MAX3	BAITCAST	
1604RS-5	1.82	5	42.2	127	15-80	MAX4	BAITCAST	
1652R-5	1.98	5	46.2	117	7-28	MAX2	BAITCAST	
1653R-5	1.98	5	46.2	127	10-40	MAX3	BAITCAST	
1703R-5	2.13	5	47.1	140	10-40	MAX3	BAITCAST	
1704R-5	2.13	5	47.1	145	15-80	MAX4	BAITCAST	
2651F-5	1.98	5	46.7	112	5-15	MAX1.2	SPINNING	
2702R-5	2.13	5	47.1	122	7-20	MAX1.5	SPINNING	
2754R-5	2.29	5	50.3	167	15-80	MAX4	SPINNING	
2832RS-5	2.51	5	54.7	145	7-30	MAX2	SPINNING	
2833RS-5	2.51	5	54.7	175	10-50	MAX3	SPINNING	

## WORLD SHAULA BG

Versatile new chapter. Trust the power.



※1 : 1952R-3, 1954R-3, 2952R-3, 2953R-3, 21053R-3

WORLD SHAULA BG								NEW
Model Number	Rod Length [m]	No. of Sections	Closed Length [cm]	Weight [g]	Lure Weight [g]	Line Weight [PE]	Type	
1952R-3	2.90	3	130.0	232	20-60	MAX3	BAITCAST	
1954R-3	2.90	3	130.0	240	40-120	MAX5	BAITCAST	
2836RS-2	2.51	3	130.0	350	50-150	MAX6	SPINNING	
2838R-2	2.51	2	129.4	390	70-210	MAX8	SPINNING	
2952R-3	2.90	3	130.0	245	15-40	MAX2	SPINNING	
2953R-3	2.90	3	130.0	245	20-60	MAX3	SPINNING	
21053R-3	3.20	3	130.0	255	20-60	MAX3	SPINNING	
21055R-3	3.20	3	130.0	305	40-120	MAX5	SPINNING	
21203R-3	3.66	3	130.0	370	20-60	MAX3	SPINNING	

## WORLD SHAULA Technical Edition



WORLD SHAULA TECHNICAL EDITION							
Model Number	Rod Length [m]	No. of Sections	Closed Length [cm]	Weight [g]	Lure Weight [g]	Line Weight [PE]	Type
S52UL-3/F	1.57	3	55.7	83	0.7-8	0.2-0.6	SPINNING
S52L-3/MD	1.57	3	55.7	83	1.5-10	0.3-0.8	SPINNING
S62XUL-2	1.88	2	130.0	87	0.4-3.5	0.2-0.6	SPINNING
S62SUL-2	1.88	2	130.0	87	0.6-6	0.2-0.6	SPINNING
S62UL-2/F	1.88	2	130.0	90	0.7-8	0.2-0.6	SPINNING
S62L-2/MD	1.88	2	130.0	90	1.5-10	0.3-0.8	SPINNING
S66SUL-2	1.98	2	130.0	90	0.6-6	0.2-0.6	SPINNING
S66UL-2/F	1.98	2	130.0	90	0.7-8	0.2-0.6	SPINNING
S66L-2/MD	1.98	2	130.0	93	1.5-10	0.3-0.8	SPINNING

# Bantam

Shimano's flagship model in the [Bass Rod] category - the Bantam.

Shimano has decided to entirely revamp what the Bantam family of bass rods is able to offer to anglers. Simply put, the difference between the old and the new lineup of Bantam rods is the Spiral X Core technology which has now been integrated into the manufacturing process of the blanks in the new lineup. Retaining its performance, these rods aim to also retain the trust and confidence anglers have had in them since the launch of their preceding models.



※1: 274M+  
※2: 264UL-S/2

BANTAM <span style="float: right;">NEW</span>							
Model Number	Rod Length [m]	No. of Sections	Closed Length [cm]	Weight [g]	Lure Weight [g]	Line Weight [PE]	Type
<b>1-PIECE</b>							
165MH	1.96	1	196.1	TBC	10-30	MAX4	BAITCAST
168M	2.03	1	203.1	TBC	7-21	MAX3	BAITCAST
170MH	2.13	2	182.8	TBC	10-30	MAX4	BAITCAST
172H	2.18	2	187.3	TBC	14-42	MAX5	BAITCAST
264ML	1.93	1	193.1	TBC	4-12	MAX1.2	SPINNING
267L	2.01	1	201.0	TBC	3-10	MAX1	SPINNING
269M	2.06	2	180.3	TBC	5-15	MAX1.5	SPINNING
274M+	2.24	2	196.7	TBC	5-21	MAX1.5	SPINNING
<b>2-PIECE</b>							
163ML-2	1.91	2	130.0	TBC	5-15	MAX2	BAITCAST
168L+BFS/2	2.03	2	104.6	TBC	3.5-15	MAX1.5	BAITCAST
168ML+G/2	2.03	2	130.0	TBC	5-21	MAX2	BAITCAST
168XH-SB/2	2.03	2	130.0	TBC	MAX150	MAX6	BAITCAST
170M+G/2	2.13	2	129.9	TBC	7-30	MAX3	BAITCAST
1711MH+SB/2	2.41	2	130.0	TBC	10-100	MAX4	BAITCAST
264UL-S/2	1.94	2	99.8	TBC	1.5-6	TBC	SPINNING

Bantam 170MH



Bantam 274M+



# EXPRIDE

A comprehensive lineup catering to modern needs.

Shimano proudly presents a modern lineup of bass rods with one of the highest cost performance. This total revamp of the EXPRIDE rod family was conceptualized based on an impregnable iron fortress to cater to modern techniques and trends among the anglers of today. An edge type carbon monocoque grip is used to improve the cosmetics without sacrificing the comfort it offers anglers. The basis of the designs have been kept to fulfil conventional means with a twist to cater to modern techniques such as big baits, mid-strolling, power finesse, etc. This new lineup of EXPRIDE rods is confident that there will be a rod that suits any bass angler, regardless of traditional or modern needs.



※1:1610M-S ※2:261SUL+, 265UL+, 267L+ ※3:263L-S, 263L-S/2, 2610M-S

EXPRIDE							NEW
Model Number	Rod Length [m]	No. of Sections	Closed Length [cm]	Weight [g]	Lure Weight [g]	Line Weight [lb]	Type
<b>1-PIECE GRIP JOINT</b>							
163L-BFS	1.91	2	163.8	90	3.5-10	6-12	BAITCAST
165ML-BFS	1.96	2	168.1	110	5-15	7-14	BAITCAST
165ML-G	1.96	2	166.8	90	5-21	7-14	BAITCAST
166XH-SB	1.98	2	167.3	127	MAX150	14-30	BAITCAST
167MH	2.01	2	170.8	105	10-30	10-20	BAITCAST
1610M	2.08	2	176.3	100	7-21	8-16	BAITCAST
1610M-S	2.08	2	176.3	100	5-15	7-14	BAITCAST
170M-G	2.13	2	179.8	122	7-30	8-16	BAITCAST
170MH	2.13	2	182.3	120	10-30	10-20	BAITCAST
172MH	2.18	2	186.5	122	10-30	10-20	BAITCAST
172H	2.18	2	186.0	120	14-42	12-25	BAITCAST
259UL	1.75	2	149.8	77	2-7	2.5-5	SPINNING
261SUL+	1.85	2	157.8	82	1.5-7	2-4	SPINNING
263L-S	1.91	2	163.3	82	2-7	2.5-5	SPINNING
264UL	1.93	2	165.3	85	2-7	2.5-5	SPINNING
264M+	1.93	2	164.3	87	5-21	5-10	SPINNING
265UL+	1.96	2	166.3	87	2-10	2.5-5	SPINNING
266L	1.98	2	169.8	87	3-10	3-6	SPINNING
267L+	2.01	2	171.3	87	3-12	3-6	SPINNING
2610ML	2.08	2	178.6	90	4-12	4-8	SPINNING
2610M-S	2.08	2	178.2	90	4-12	4-8	SPINNING
270MH+	2.13	2	182.8	100	7-30	6-12	SPINNING
<b>2-PIECE MID JOINT</b>							
163L-BFS/2	1.91	2	98.5	90	3.5-10	6-12	BAITCAST
166XH-SB/2	1.98	2	102.0	125	MAX150	14-30	BAITCAST
167MH-2	2.01	2	103.5	112	10-30	10-20	BAITCAST
1610M-2	2.08	2	107.0	100	7-21	8-16	BAITCAST
172MH-2	2.18	2	112.0	117	10-30	10-20	BAITCAST
172H-2	2.18	2	112.0	120	14-42	12-25	BAITCAST
263L-S/2	1.91	2	98.5	87	2-7	2.5-5	SPINNING
264UL-2	1.93	2	99.5	87	2-7	2.5-5	SPINNING
266L-2	1.98	2	102.0	92	3-10	3-6	SPINNING
2610ML-2	2.08	2	107.0	92	4-12	4-8	SPINNING
272MH-2	2.18	2	112.0	105	7-21	6-12	SPINNING

EXPRIDE 1610M

EXPRIDE 265UL+



# Scorpion

Without focusing on geographical factors, the Scorpion is a multipurpose travel rod which is capable of following anglers around the world.

The high portability of the rod is made possible with its One-and-Half Piece and 5-piece structures. With a regular taper making up the rod's action and a guide system which allows for both thin and thick lines to be used without problems, the Scorpion series is back, now more versatile than ever!



SCORPION <span style="float: right;">NEW</span>							
Model Number	Rod Length [m]	No. of Sections	Closed Length [cm]	Weight [g]	Lure Weight [g]	Line Weight [lb]	Type
<b>1-PIECE</b>							
1581F-2	1.73	2	130.0	115	5-20	8-16	BAITCAST
1600SS-2	1.83	2	130.0	115	3.5-14	6-16	BAITCAST
1631FF-2	1.91	2	130.0	115	4-16	8-14	BAITCAST
1651R-2	1.98	2	130.0	120	5-20	8-16	BAITCAST
1652R-2	1.98	2	130.0	127	7-28	12-22	BAITCAST
1653RS-2	1.98	2	130.0	132	10-40	14-30	BAITCAST
1702R-2	2.13	2	130.0	140	7-28	12-25	BAITCAST
1703R-2	2.13	2	130.0	147	10-40	14-30	BAITCAST
1704R-2	2.13	2	130.0	152	15-80	16-40	BAITCAST
1752R-2	2.29	2	130.0	147	7-28	12-25	BAITCAST
1787RS-2	2.34	2	130.0	195	15-240	16-70	BAITCAST
17113R-2	2.41	2	130.0	165	10-40	14-30	BAITCAST
2651R-2	1.98	2	130.0	117	5-15	5-12	SPINNING
2652R-2	1.98	2	130.0	115	7-20	6-14	SPINNING
2701FF-2	2.13	2	130.0	120	4-14	4-10	SPINNING
2702R-2	2.13	2	130.0	130	8-20	7-20	SPINNING
2831R-2	2.51	2	130.0	150	5-15	5-12	SPINNING
2832RS-2	2.51	2	130.0	152	7-30	10-24	SPINNING
<b>5-PIECE</b>							
15101F-5	1.78	5	42.5	115	5-20	8-16	BAITCAST
15103RS-5	1.77	5	42.7	130	10-40	14-30	BAITCAST
1602R-5	1.83	5	43.8	122	7-28	12-22	BAITCAST
1604SS-5	1.82	5	43.0	140	15-80	16-50	BAITCAST
1652R-5	1.98	5	47.0	130	7-28	12-22	BAITCAST
2600FF-5	1.82	5	44.6	110	2-8	3-8	SPINNING
2602R-5	1.83	5	44.1	110	7-20	6-14	SPINNING
2651R-5	1.98	5	47.6	117	5-15	5-12	SPINNING

# Scorpion XV

The Scorpion XV lineup consists of entry-level freestyle rods for lure fishing.

They are easily handled by a wide range of anglers and offers use with familiar targets regardless of freshwater or seawater, including black bass fishing. The length is a lineup of popular counts of the successive Scorpion series, including the much-requested 4-foot ultra-short rod. A rod bag is specially made with a shoulder sling so that anglers can even carry the rod on bicycles!



SCORPION XV <span style="float: right;">NEW</span>							
Model Number	Rod Length [m]	No. of Sections	Closed Length [cm]	Weight [g]	Lure Weight [g]	Line Weight [lb]	Type
1501FF-2	1.52	2	78.5	105	4-16	7-14	BAITCAST
1581F-2	1.73	2	89.0	115	5-21	7-14	BAITCAST
1651F-2	1.98	2	101.5	125	5-21	7-14	BAITCAST
1652R-2	1.98	2	101.3	127	7-30	8-16	BAITCAST
2401FF-2	1.22	2	63.5	75	3-12	3-6	SPINNING
2451R-2	1.37	2	71.0	77	4-15	4-8	SPINNING
2501FF-2	1.52	2	78.5	80	3-12	3-6	SPINNING
2550FF-2	1.68	2	86.5	80	2-8	2.5-5	SPINNING
2601F-2	1.83	2	94.0	97	4-15	4-8	SPINNING
2602R-2	1.83	2	94.0	107	5-21	5-10	SPINNING

Scorpion 1652R-2

Scorpion 2651R-2

Scorpion XV 2601F-2

# ZODIAS

Equipped with the Carbon Monocoque Grip. FEEL the experience of an improved world class rod.

Just like a small electric current flowing across the body, feel the tingling sensation from detecting underwater activity with the carbon monocoque grip. Bringing you both the confidence to fish fearlessly and sensation for a wholesome fishing experience, this global standard Zodiacs rods offers games on a whole other level to anglers.



※1: 167M-S, 167M-S/2, 169MH-S, 169MH-S/2

※2: 167M-S, 167M-S/2, 169MH-S, 169MH-S/2, 264UL-S, 264UL-S/2, 268L-S, 268L-S/2.

## ZODIAS NEW

Model Number	Rod Length [m]	No. of Sections	Closed Length [cm]	Weight [g]	Lure Weight [g]	Line Weight [lb]	Type
164L-BFS	1.93	2	166.7	92	4-12	6-12	BAITCAST
166ML	1.98	2	169.7	95	5-15	7-14	BAITCAST
166ML-G	1.98	2	168.6	117	5-21	7-16	BAITCAST
166M	1.98	2	169.2	102	7-21	8-16	BAITCAST
166MH	1.98	2	168.6	108	10-30	10-20	BAITCAST
167M-S	2.01	2	172.2	97	4-15	6-12	BAITCAST
168L-BFS	2.03	2	174.7	97	4-12	6-12	BAITCAST
169MH-S	2.06	2	176.1	107	5-21	7-14	BAITCAST
1610ML	2.08	2	178.9	107	5-15	6-12	BAITCAST
1610M	2.08	2	178.2	110	7-21	8-16	BAITCAST
1610MH	2.08	2	177.7	112	10-30	10-20	BAITCAST
170M-G	2.13	2	181.1	132	7-28	8-20	BAITCAST
172MH	2.18	2	185.6	122	10-30	10-20	BAITCAST
172H	2.18	2	184.6	127	12-42	12-25	BAITCAST
264UL-S	1.93	2	167.7	92	1.5-5	2-5	SPINNING
264UL	1.93	2	167.7	95	2-7	2-5	SPINNING
264L	1.93	2	167.7	95	3-10	3-6	SPINNING
266ML-G	1.98	2	171.0	117	4-15	5-10	SPINNING
268L-S	2.03	2	177.3	92	2.5-10	3-6	SPINNING
268L	2.03	2	177.2	97	3-10	3-6	SPINNING
268ML	2.03	2	177.2	100	4-12	4-8	SPINNING

## ZODIAS 2-PIECE

164L-BFS/2	1.93	2	99.2	92	4-12	6-12	BAITCAST
166ML-2	1.98	2	101.7	100	5-15	7-14	BAITCAST
166ML-G/2	1.98	2	101.8	112	5-21	7-16	BAITCAST
166M-2	1.98	2	101.7	102	7-21	8-16	BAITCAST
166MH-2	1.98	2	101.6	105	10-30	10-20	BAITCAST
167M-S/2	2.01	2	103.0	100	4-15	6-12	BAITCAST
168L-BFS/2	2.03	2	104.2	100	4-12	6-12	BAITCAST
169MH-S/2	2.06	2	105.8	107	5-21	7-14	BAITCAST
1610ML-2	2.08	2	106.8	102	5-15	6-12	BAITCAST
1610M-2	2.08	2	106.7	107	7-21	8-16	BAITCAST
1610MH-2	2.08	2	106.7	110	10-30	10-20	BAITCAST
170M-G/2	2.13	2	109.2	120	7-28	8-20	BAITCAST
172MH-2	2.18	2	111.9	125	10-30	10-20	BAITCAST
172H-2	2.18	2	111.7	130	12-42	12-25	BAITCAST
176M-2	2.29	2	117.2	125	7-21	8-16	BAITCAST
264UL-S/2	1.93	2	99.2	90	1.5-5	2-5	SPINNING
264UL-2	1.93	2	99.2	92	2-7	2-5	SPINNING
264L-2	1.93	2	99.2	92	3-10	3-6	SPINNING
266ML-G/2	1.98	2	101.7	110	4-15	5-10	SPINNING
268L-S/2	2.03	2	104.3	92	2.5-10	3-6	SPINNING
268L-2	2.03	2	104.2	95	3-10	3-6	SPINNING
268ML-2	2.03	2	104.2	97	4-12	4-8	SPINNING
270M-2	2.13	2	109.2	107	5-15	5-10	SPINNING
270MH-2	2.13	2	109.3	112	7-21	6-12	SPINNING



## ZODIAS (PACK ROD) NEW

Model Number	Rod Length [m]	No. of Sections	Closed Length [cm]	Weight [g]	Lure Weight [g]	Line Weight [lb]	Type
C58ML-4	1.73	4	47.9	102	5-15	7-14	BAITCAST
C66ML-5	1.98	5	43.7	107	5-15	7-14	BAITCAST
C610M-5	2.08	5	46.1	120	7-21	8-16	BAITCAST
C72MH-5	2.18	5	48.1	132	10-30	10-20	BAITCAST
S64L-5	1.93	5	43.1	105	3-10	3-6	SPINNING
S68ML-5	2.03	5	45.1	110	4-12	4-8	SPINNING
S70M-5	2.13	5	47.1	115	5-15	5-10	SPINNING

ZODIAS 170M-G/2

ZODIAS 264UL-S/2

ZODIAS PACK ROD C58ML-4

# PANZAR

Panzar is a specially-craft series to cater to all the lure enthusiasts' demand.

There are various SKUs to choose from to suit the different kind of lure fishing that you want to do. This is a super versatile spinning model. If you can only bring one rod to go fishing, this is the rod that we would recommend!

PANZAR					
Model Number	Rod Length [m]	No. of Sections	Lure Weight [g]	Line Weight [lb]	Type
166ML-2	1.98	2	5-15	8-16	BAITCAST
166M-2	1.98	2	7-21	10-20	BAITCAST
168L-BFS	2.03	2	4-12	6-12	BAITCAST
1610ML-2	2.08	2	5-15	10-20	BAITCAST
1610M-2	2.08	2	7-21	10-20	BAITCAST
258M-2	1.72	2	4-18	8-16	SPINNING
262ML-2	1.88	2	4-12	5-10	SPINNING
264L-2	1.93	2	3-10	4-8	SPINNING
264M-2	1.93	2	4-18	8-16	SPINNING
268ML-2	2.03	2	4-12	6-12	SPINNING
272ML-2	2.19	2	7-35	12-25	SPINNING
276ML	2.30	2	10-35	12-25	SPINNING

# PANZAR S.T.C.

PANZAR STC					
Model Number	Rod Length [ft]	No. of Sections	Lure Weight [g]	Line Weight [lb]	Type
S6070-5	6'>7'	5	4-12	5-12	SPINNING
S7080-5	7'>8'	5	7-26	6-16	SPINNING
S8090-5	8'>9'	5	8-30	7-20	SPINNING
S9010-5	9'>10'	5	10-35	8-25	SPINNING

# PANZAR UD

UD=Ultra Durable. We made this rod to allow anglers to confidently handle any unknown fishing situation.

Panzar UD series is available in 3 length, 6'3", 6'9" and 7'2". Choose the rod length according to your fishing environment. For close quarters and fishing from a small boat, the 6'3" would be perfect and can handle lures up to 40g easily. For shore based fishing, the 7'2" is highly recommended as the extra length means an extra long cast.

PANZAR UD					
Model Number	Rod Length [ft]	No. of Sections	Lure Weight [g]	Line Weight [PE]	Type
B63H	6'3"	2	MAX50	1.3	BAITCAST
B69H	6'9"	2	MAX60	2.4	BAITCAST
B72H	7'2"	2	MAX70	2.5	BAITCAST

# BASS ONE XT

Basic Model reborn with luxurious specifications.

Made for the latest freshwater fishing trends with specifications that defy conventions. Successfully lightened by about 10% from the previous range, gorgeous specifications are adopted such as lightweight reel seat and separate EVA grips.

BASS ONE XT							
Model Number	Rod Length [m]	No. of Sections	Closed Length [cm]	Weight [g]	Lure Weight [g]	Line Weight [lb]	Type
150ML-2	1.52	2	79.2	97	5-14	8-16	BAITCAST
156ML-2	1.68	2	87.0	102	5-14	8-16	BAITCAST
162ML-2	1.88	2	97.2	107	5-14	8-16	BAITCAST
162M-2	1.88	2	97.2	110	7-21	10-20	BAITCAST
166ML-2	1.98	2	102.2	117	5-14	8-16	BAITCAST
166M-2	1.98	2	102.2	117	7-21	10-20	BAITCAST
166MH-2	1.98	2	102.2	121	10-28	10-24	BAITCAST
1610M-2	2.08	2	107.2	120	7-21	10-20	BAITCAST
1610MH-2	2.08	2	107.2	125	10-28	10-24	BAITCAST
1610H-2	2.08	2	107.7	122	12-35	12-24	BAITCAST
256UL-2	1.68	2	87.0	90	1-5	3-5	SPINNING
260UL-2	1.83	2	94.7	97	1-5	3-5	SPINNING
260L-2	1.83	2	94.7	94	2-7	4-7	SPINNING
263UL-2	1.90	2	98.2	97	1-5	3-5	SPINNING
263L-2	1.90	2	98.2	97	2-7	4-7	SPINNING
263ML-2	1.90	2	98.2	98	3-10	4-8	SPINNING
266L-2	1.98	2	102.2	100	2-7	4-7	SPINNING
266ML-2	1.98	2	102.2	100	3-10	4-8	SPINNING



RODS

FEATURES

JIGGING

POPPING/CASTING

BOAT GAME

BASS

GALATAMA

MULTI-PIECE SURF

TELESCOPIC SURF

SPECIAL

EGING



BASSTERRA EV

LUREMATIC BS8L

LUREMATIC S66ML

SLX BAITCAST

## BASSTERRA **EV**

Equipped with Full Fuji Components, this rod pushes above its weight class. Rod action is tuned to be fast to cater to different fishing situation.

Extra attention is placed to ensure that this rod is durable and will bring joy to angler for years to come.

BASSTERRA EV					
Model Number	Rod Length [ft]	No. of Sections	Lure Weight [g]	Line Weight [lb]	Type
S56M	5'6"	2	4-18	8-16	SPINNING
S60M	6'0"	2	4-18	8-16	SPINNING
S66MH	6'6"	2	4-18	8-16	SPINNING
S70MH	7'0"	2	12-35	12-20	SPINNING
S80MH	8'0"	2	16-40	12-25	SPINNING
S9010MH	9'>10'	3	18-40	16-30	SPINNING

## LUREMATIC

The Lurematic range of rods are designed to suit South East Asia Fishing style.

Made to produce medium to medium heavy action, the action of the rod promises to deliver a satisfying user experience. Equipped with Fuji guide and Fuji reel seat, this rod is made to be durable and still maintain its sensitivity to ensure that you feel even the slightest nibble on the rod. Available from 5ft to 9ft, the Lurematic series is affordable and a must have for all lure anglers.

LUREMATIC							
Model Number	Rod Length [m]	No. of Sections	Closed Length [cm]	Weight [g]	Lure Weight [g]	Line Weight [lb]	Type
BS8L	1.73	2	89.2	107	7-18	10-16	BAITCAST
B66ML	1.98	2	101.9	122	8-22	10-22	BAITCAST
S50M	1.52	2	78.8	80	4-18	8-16	SPINNING
S56SUL	1.68	2	86.4	80	1.5-4.5	2.5-4	SPINNING
S56UL	1.68	2	87.4	85	2-6	3-6	SPINNING
S56M	1.68	2	86.8	90	5-21	8-16	SPINNING
S60SUL	1.83	2	94.0	88	1.5-4.5	2.5-4	SPINNING
S60UL	1.83	2	94.8	90	2-6	3-6	SPINNING
S60L	1.83	2	94.3	120	5-14	5-10	SPINNING
S60M	1.83	2	94.3	105	7-28	8-16	SPINNING
S66L	1.98	2	101.9	125	5-14	5-10	SPINNING
S66ML	1.98	2	101.9	130	7-18	6-14	SPINNING

## SLX

SLX offers tournament level performance at a price that all anglers can afford.

With versatile actions throughout the lineup, there is an SLX to cover any technique. SLX rods feature an attractive and sensitive carbon foregrip, as well as a Shimano custom reel seat.

SLX					
Model Number	Rod Length [ft]	No. of Sections	Lure Weight [g]	Line Weight [lb]	Type
S8ML	5'8"	1	5-18	10-20	BAITCAST
S10M	5'10"	1	7-28	15-20	BAITCAST
60MH	6'0"	1	10-35	15-40	BAITCAST
70MH2	7'0"	2	5-17	8-30	SPINNING
60M2	6'9"	2	7-21	10-40	SPINNING

# Majestic XT

The One for All - Upgraded.  
Majestic XT is the next step up for entry level lure fishing.

Equipped with Fuji O-Ring guides, ergonomic EVA handle grips, Carbon Lock Nut and Hook Keeper. Sensitive Solid Tip models and Power models were added to further expand the range to cover every lure angling style.

MAJESTIC XT							NEW
	Model Number	Rod Length [m]	No. of Sections	Closed Length [cm]	Lure Weight [g]	Line Weight [lb]	Type
Bait Finesse	B54UL-BFS/2	1.63	2	84.5	2-7	4-10	BAITCAST
	B65L-S/2	1.96	2	101.5	2-7	4-10	BAITCAST
Sensitive Solid Tip	B78L+S/2	2.34	2	121.0	2-15	4-10	BAITCAST
	B68ML+2	2.03	2	105.5	5-28	7-14	BAITCAST
Versatile	B610M-2	2.08	2	107.5	7-28	8-16	BAITCAST
	B72ML-2	2.18	2	113.0	5-20	7-14	BAITCAST
	B72M-2	2.18	2	113.0	7-28	8-16	BAITCAST
Power Model	B74MH-2	2.24	2	116.0	10-35	10-20	BAITCAST
	B74XH-2	2.24	2	116.0	18-56	14-30	BAITCAST
Long Cast	B78ML-2	2.34	2	121.0	5-20	7-14	BAITCAST
	B78M-2	2.34	2	121.0	7-28	8-16	BAITCAST
Sensitive Solid Tip	S64L-S/2	1.93	2	100.5	3-10	2-5	SPINNING
	S68ML-S/2	2.03	2	105.5	5-15	3-6	SPINNING
Versatile	S62UL-2	1.88	2	98.0	3-10	2-5	SPINNING
	S610M-2	2.08	2	107.5	8-24	5-10	SPINNING
Long Cast	S72ML+2	2.18	2	113.0	7-24	4-8	SPINNING
	S78ML-2	2.34	2	121.0	7-21	4-8	SPINNING
	S78M-2	2.34	2	121.0	8-24	5-10	SPINNING
	S82ML+2	2.49	2	129.0	7-24	4-8	SPINNING

# Majestic

The one for all.

Majestic is a one-stop solution to entry level fresh and saltwater lure games. The Majestic range of rods is equipped with a combination of EVA and cork grip for better ergonomics, durable O-ring guides for casting enjoyment, hook keeper to hold your lures and also a rod bag for storage. Available in 13 models for every situation, a must have for lure anglers!

MAJESTIC						
Model Number	Rod Length [m]	No. of Sections	Closed Length [cm]	Lure Weight [g]	Line Weight [PE]	Type
B64L-BFS-2	1.93	2	99.2	3-15	0.6-1.5	BAITCAST
B66ML-2	1.98	2	103.0	5-20	0.8-2	BAITCAST
B68L-BFS-2	2.03	2	104.2	3-15	0.6-1.5	BAITCAST
B610ML-2	2.08	2	106.7	5-20	0.8-2	BAITCAST
B610M-2	2.08	2	106.7	7-28	1-2.5	BAITCAST
B610MH-2	2.08	2	106.7	10-35	1.2-3	BAITCAST
B76ML-2	2.29	2	117.7	5-20	0.8-2	BAITCAST
B76M-2	2.29	2	117.7	7-28	1-2.5	BAITCAST
S66L-2	1.98	2	103.0	5-15	0.3-1	SPINNING
S610ML-2	2.08	2	106.7	7-21	0.4-1.2	SPINNING
S74MH-2	2.24	2	118.2	10-30	0.8-2	SPINNING
S80ML-2	2.44	2	124.7	7-21	0.4-1.2	SPINNING
S80M-2	2.44	2	124.7	8-24	0.6-1.5	SPINNING

# CRUZAR XT

Designed to be a strong & durable general purpose rod, the Cruzar XT is built on 24Ton Carbon Fibre Composite blanks.

Equipped with all Stainless Steel double foot guides, ergonomic EVA grips & reel seat, durable compressed cork butt end and finished in an attractive Purple/Blue muse color paint to be admired under the sun. Multiple rod lengths are available to offer versatility from Shore Casting to Pond bottom fishing.

CRUZAR XT							NEW
Model Number	Rod Length [m]	No. of Sections	Closed Length [cm]	Weight [g]	Lure Weight [g]	Line Weight [lb]	Type
CRZXT2562	1.70	2	88.0	147	6-12	5-10	SPINNING
CRZXT2602	1.84	2	95.0	185	8-16	6-12	SPINNING
CRZXT2662	1.98	2	102.0	205	10-20	8-16	SPINNING
CRZXT2702	2.12	2	109.0	209	10-25	10-20	SPINNING
CRZXT2802	2.43	2	125.0	256	12-30	12-24	SPINNING
CRZXT21002	3.05	2	156.0	350	16-40	15-30	SPINNING





LESATH GS 2602F

BASSTERRA GS

BASSTERRA EV GS

AERNOS GS

SCIMITAR GS

## LESATH GS

The latest generation of freshwater competition spinning rods.

When fishing in stocked ponds, it is common for the fishes inside to be wary especially with species like Patin, Bighead Carp and Rohu. These notoriously finicky fishes requires a rod with an ultra-sensitive tip to register the tiniest bites and still possess the power to control and stop these rampaging fish from swimming to stuck. The design is a representation of classic design using modern techniques creating the perfect blend in form and function.



LESATH GS						
Model Number	Rod Length [ft]	No. of Sections	Closed Length [cm]	Lure Weight [g]	Line Weight [lb]	Type
2602F	6'0"	2	95	4-18	8-16	SPINNING

## BASSTERRA GS

Uncompromising & surprising performance from a production rod which performs like a custom built rod.

When fishing in stocked ponds, it is common for the fishes inside to be wary Aero guide design ensures line slither through the guides with minimal resistance. The light weight & ergonomic Perfection reel seat found in this new rod provides a firm & comfortable grip for the angler to make every cast to be smooth & accurate. Bassterra GS is your perfect weapon for Galatama style competition use!

BASSTERRA GS					
Model Number	Rod Length [ft]	No. of Sections	Lure Weight [g]	Line Weight [lb]	Type
2562F	5'6"	2	4-18	8-16	SPINNING
2602F	6'0"	2	4-18	8-16	SPINNING

## BASSTERRA EV GS

BASSTERRA EV GS					
Model Number	Rod Length [ft]	No. of Sections	Lure Weight [g]	Line Weight [lb]	Type
S56M	5'6"	2	4-18	8-16	Spinning
S60M	6'0"	2	4-18	8-16	Spinning

## AERNOS GS

Aernos GS features a fast action blank tuned for Galatama fishing.

Priced competitively, it offers great value and also it is equipped with Fuji O-Ring guides, Fuji Reelseat, Cork grip handles and a rod retainer.

AERNOS GS						NEW
Model Number	Rod Length [m]	No. of Sections	Closed Length [cm]	Lure Weight [g]	Line Weight [lb]	Type
S60M	1.83	2	96.5	3-14	6-12	SPINNING

## SCIMITAR GS

Scimitar GS is an entry level rod specially designed for Galamtama fishing.

A rod retainer is included to complete the package.

SCIMITAR GS						NEW
Model Number	Rod Length [m]	No. of Sections	Closed Length [cm]	Lure Weight [g]	Line Weight [lb]	Type
S60M	1.83	2	95.0	3-14	6-12	SPINNING

# Surf Lander 並継

Top Blank Construction; Spiral X. Top reinforcement: High Power X and not forgetting top quality Fuji component.

This rod is a high spec rod that comes at a reasonable price. This rod is designed to cast far with its unique taper, ergonomic shape, Cascon grip and Fuji SiC guide. This rod employs the latest K-guide from Fuji and Shimano X Guide to reduce wind knots during your casts



## SURF LANDER NEW

Model Number	Rod Length [m]	No. of Sections	Closed Length [cm]	Weight [g]	Sinker [no.]
385EX	3.87	3	136.6	TBC	20-30
385DX	3.87	3	136.6	TBC	23-30
405EX	4.07	3	143.1	TBC	20-30
405DX	4.07	3	143.1	TBC	23-30
405CX	4.07	3	143.1	TBC	25-35
405BX	4.07	3	143.1	TBC	27-35
425CX	4.27	3	150.1	TBC	25-35
425BX	4.27	3	150.1	TBC	27-35

# SURF GAZER 並継

A model specially made for casters who wish to challenge themselves and dive into the surfcasting section of the fishing sport.

Suppressing the effects of torsional loads imposed during casting motions, the rod is equipped with Hi Power X technology to convey the power of the caster into the cast efficiently.



## SURF GAZER

Model Number	Rod Length [m]	No. of Sections	Closed Length [cm]	Weight [g]	Sinker [no.]
405EX	4.05	3	143.0	345	20-30
405DX	4.05	3	143.0	375	23-30
405CX	4.05	3	143.0	400	25-35
405BX	4.05	3	143.0	435	27-35
425CX	4.25	3	150.0	445	25-35
425BX	4.25	3	150.0	475	27-35

# SWINGCAST

Renewing a staple in Shimano's range of three-piece surf rods is the renewed Swingcast surf rod which now comes in 2 different lengths 4.25m, 4.50m.

Built on technically superior material, this range is designed for anglers who want longer casts every time! Equipped with Fuji MN alconite guides, this rod is the perfect choices for anglers who prefer to use nylon line for surf casting. This is a serious rod for the long caster.

## SWINGCAST

Model Number	Rod Length [m]	No. of Sections	Casting Weight [g]	Type
425BX	4.25	3	225	SPINNING
450BX	4.50	3	225	SPINNING



Surf Lander 405CX

SURF GAZER 405CX

SWINGCAST 450BX



NEXAVE SURF

VENGEANCE BX

## NEXAVE SURF

The Nexave Surf (3PC) is a mid-segment rod with excellent casting capabilities and beautiful looks.

The 450 model has DPS reel seat. It's built to cast big distances, while at the same time keeping good bite detection. The tip is tubular (hollow) for extra far distance casting.

### NEXAVE SURF

Model Number	Rod Length [m]	No. of Sections	Closed Length [cm]	Casting Weight [g]	Type
450BX	4.50	3	158.0	MAX225	SPINNING

## VENGEANCE BX

The Vengeance Surf rod is renewed and improved in blank, guides and looks.

- Strongly improved blank which has much more power. The rod is much stiffer, more responsive and powerful. This results in better casting distance.
- The tip sections have reduced diameters (0,5 mm less) which makes them lighter and more sensitive for better bite registration.
- Cast Control Grip for good grip when casting.

### VENGEANCE BX

Model Number	Rod Length [m]	No. of Sections	Casting Weight [g]	Type
425BXK	4.25	3	225	SPINNING
450BXK	4.50	3	225	SPINNING



## PRO SELECT 振出

"PRO SELECT" pursues the ideal form of long-distance fishing.

The Spiral X and Hi-Power X technologies are used for the blanks to maximize the power output of the casters. We have designed the blanks in a way that makes it easy to perform full-blown casts. The performance produced from blanks achieves both exemplary casting distances and user control. Even if a strong fish strikes at your bait, the butt of the rod provides a highly elastic rebound strength, allowing for immediate control of the fish, not letting it get away. New Fuji RV30 guide is used for the stripper guide to accommodate the use of thick nylon lines during fishing. Line troubles become a worry of the past while you keep making those long distance casts.



PROSELECT <span style="float: right;">NEW</span>						
Model Number	Rod Length [m]	No. of Sections	Closed Length [cm]	Weight [g]	Sinker Weight [no.]	Type
405DX-T	4.05	4	128.5	365	23-30	SPINNING
405CX-T	4.05	4	128.5	390	25-35	SPINNING
405BX-T	4.05	4	128.5	420	27-35	SPINNING
405AX-T	4.05	4	128.5	450	30-40	SPINNING
425DX-T	4.26	4	135.5	395	23-30	SPINNING
425CX-T	4.26	4	135.5	425	25-35	SPINNING
425BX-T	4.26	4	135.5	460	27-35	SPINNING
425AX-T	4.26	4	135.5	500	30-40	SPINNING

## PROSURF 振出

The PROSURF is a rod with the double X structure formed from the application of Hi Power X and Spiral X technologies which helps maintain a stable long distance cast.

To further increase the casting distance, the MN guides used on the rod has a larger diameter, resulting in a decrease in line friction and an increase in smoothness of outgoing line. With a well balanced tip which makes lures look more enticing to target fishes and a butt with enough power to cast long distances and reel up large fishes, anglers are able to get a taste of the thrilling experience of surfcasting. The PROSURF series comes in a single length of 4.15m which makes the rods lighter than a 4.25m equivalent, resulting in a more comfortable experience whether it is shore casting or rock fishing.



PROSURF						
Model Number	Rod Length [m]	No. of Sections	Closed Length [cm]	Weight [g]	Lure Weight [no.]	Type
415EX-T	4.15	4	122.5	395	20-30	SPINNING
415DX-T	4.15	4	122.5	415	23-30	SPINNING
415CX-T	4.15	4	122.5	440	25-35	SPINNING
415BX-T	4.15	4	123.5	475	27-35	SPINNING
415AX-T	4.15	4	123.5	520	30-40	SPINNING

## Surf Lander 振出

A worthy addition to our surfcast range. The Surf Lander.

With its classy blue finish, the rod will appeal to a wide group of surf casting. Using quality Fuji components on the rod, this rod promises to deliver long lasting performance.



SURF LANDER						
Model Number	Rod Length [m]	No. of Sections	Closed Length [cm]	Weight [g]	Lure Weight [no.]	Type
405EX-T	4.05	4	117.0	370	20-30	SPINNING
405DX-T	4.05	4	117.0	395	23-30	SPINNING
405CX-T	4.05	4	117.0	415	25-35	SPINNING
405BX-T	4.05	4	117.0	445	27-35	SPINNING
425EX-T	4.26	4	124.0	400	20-30	SPINNING
425DX-T	4.26	4	124.0	430	23-30	SPINNING
425CX-T	4.26	4	124.0	450	25-35	SPINNING
425BX-T	4.26	4	124.0	490	27-35	SPINNING

PROSELECT 405CX-T

PROSURF 415CX-T

Surf Lander 425CX-T

SURF LEADER 405DX-T



SURF CHASER 425EX-T



# SURF LEADER 振出

The Surf Leader is the ultimate rod to use for surf fishing where you need portability without any compromise on performance.

Everything about this rod is purpose built and no effort has been spared to make it a serious big fish fighting tool. The rod features full Fuji SiC guides that sit on our propriety Shimano guides grooves to prevent twisting. It also comes with a Cascon Grip and a lightweight Fuji plate type reel seat.



## SURF LEADER

Model Number	Rod Length [m]	No. of Sections	Closed Length [cm]	Weight [g]	Lure Weight [no.]	Type
385DX-T	3.85	4	112.0	350	23-30	SPINNING
405EX-T	4.05	4	115.0	350	20-30	SPINNING
405DX-T	4.05	4	115.0	375	23-30	SPINNING
405CX-T	4.05	4	115.0	400	25-35	SPINNING
405BX-T	4.05	4	115.0	430	27-35	SPINNING
425EX-T	4.25	4	122.0	380	20-30	SPINNING
425DX-T	4.25	4	122.0	410	23-30	SPINNING
425CX-T	4.25	4	122.0	435	25-35	SPINNING
425BX-T	4.25	4	122.0	470	27-35	SPINNING
450DX-TL	4.50	5	105.0	405	23-30	SPINNING
450CX-TL	4.50	5	105.0	440	25-35	SPINNING

# SURF CHASER

Equipped with Hi-Power X, there is no compromise on the performance of this affordable yet reliable surf rod.

Fuji reel seat and Cascon grip usually found on higher end models are placed on this rod.



## SURF LEADER

Model Number	Rod Length [m]	No. of Sections	Closed Length [cm]	Weight [g]	Lure Weight [no.]	Type
385FX-T	3.86	4	113.0	315	18-25	SPINNING
385EX-T	3.86	4	113.0	340	20-30	SPINNING
405EX-T	4.05	4	116.0	370	20-30	SPINNING
405DX-T	4.05	4	116.0	395	23-30	SPINNING
405CX-T	4.05	4	116.0	425	25-35	SPINNING
405BX-T	4.05	4	116.0	460	27-35	SPINNING
425EX-T	4.26	4	123.0	400	20-30	SPINNING
425DX-T	4.26	4	123.0	430	23-30	SPINNING
425CX-T	4.26	4	123.0	465	25-35	SPINNING
425BX-T	4.26	4	123.0	505	27-35	SPINNING



SPEEDCAST 425CXT

## SPEEDCAST

The Speedcast surf rod has unbelievable casting ability due to the specially engineered blanks.

The rod is lightweight and display a powerful, crisp casting performance that can launch light weight to maximum distance. This rod comes equipped with Fuji Components to deliver the best cast, every cast!

SPEEDCAST					
Model Number	Rod Length [m]	No. of Sections	Closed Length [cm]	Sinker [no.]	Type
405CXT	4.05	4	114.0	25-35	SPINNING
425CXT	4.25	4	119.0	25-35	SPINNING
450CXT	4.50	4	104.0	25-35	SPINNING
425BXT	4.25	4	119.0	27-35	SPINNING



SPEEDCAST FV 360FXT

## SPEEDCAST FV

Lightweight with a powerful and crisp casting performance!

Experience unbelievable casts with the specially engineered blanks. This rod is also fully equipped with Fuji Components.

SPEEDCAST FV					
Model Number	Rod Length [m]	No. of Sections	Closed Length [cm]	Sinker [no.]	Type
360FXT	3.60	4	103.0	18-25	SPINNING
425CXT	4.25	4	120.0	25-35	SPINNING
425BXT	4.25	4	120.0	27-35	SPINNING



HOLIDAY SPIN / 405CX-T

## HOLIDAY SPIN

The Holiday Spin is designed with lightweightness in mind.

This allows anglers to fish with comfort. The feel of butt section has also been revamped and improved with a new coating method. The Cascon grip installed on the rod has further improved Cast Control efforts, making the Holiday Spin an outstanding entry model to casters.

HOLIDAY SPIN					
Model Number	Rod Length [m]	No. of Sections	Closed Length [cm]	Sinker [no.]	Type
305HX-T	3.05	4	88.0	10-20	SPINNING
335GX-T	3.35	4	95.5	15-23	SPINNING
365FX-T	3.65	4	104.0	18-25	SPINNING
385FX-T	3.85	4	109.0	18-25	SPINNING
385EX-T	3.85	4	109.0	20-30	SPINNING
405EX-T	4.05	4	114.0	20-30	SPINNING
405DX-T	4.05	4	114.0	23-30	SPINNING
405CX-T	4.05	4	114.0	25-35	SPINNING
425EX-T	4.25	4	119.0	20-30	SPINNING
425DX-T	4.25	4	119.0	23-30	SPINNING

# BeastMaster CF



BEASTMASTER CF S606



BEASTMASTER CF B606

As its name implies, the Beast Master CF is a strong rod specially designed to tackle Mekong Catfish.

Equipped with Fuji Reel seats and Fighting Butt.

## SPECIFICATIONS

BEASTMASTER CF						NEW
Model Number	Rod Length [m]	No. of Sections	Closed Length [cm]	Line Weight [PE]	Type	
S606	1.83	2	123.0	3-6	SPINNING	
B606	1.83	2	123.0	3-6	BAITCAST	



## Sephia LIMITED

Be IMPRESSED by the rods' light weight when holding it, be SURPRISED at how easy and light the rods cut through the air when making casts, and get EXCITED when you hear the whipping sound from the rods cutting the wind.



※1 : EXCLUDING S 86M

SEPHIA LIMITED							
Model Number	Rod Length [m]	No. of Sections	Closed Length [cm]	Weight [g]	Lure Weight [no.]	Line Weight [PE]	Type
S83L	2.51	2	129.0	102	1.5-3.5	0.3-0.8	SPINNING
S77ML	2.31	2	119.0	100	1.8-3.8	0.4-1	SPINNING
S85ML	2.57	2	132.0	103	1.8-3.8	0.4-1	SPINNING
S89ML	2.67	2	137.2	104	1.8-3.8	0.4-1	SPINNING
S86M	2.59	2	133.0	104	2-4	0.5-1	SPINNING

## Sephia XTUNE

Refining the series with lightness, rod sensitivity and operability. The demands and expectations on eging rods have crystallized into this High Grade model!



※1 : S82L, S86L, S79ML, S82ML, S86ML, S810ML, S92ML+

SEPHIA XTUNE <span style="color: red;">NEW</span>							
Model Number	Rod Length [m]	No. of Sections	Closed Length [cm]	Weight [g]	Egi Size [no.]	Line Weight [PE]	Type
S82L	2.49	2	127.7	102	1.5-3.5	0.3-0.8	SPINNING
S86L	2.59	2	133.3	106	1.5-3.5	0.3-0.8	SPINNING
S79ML	2.36	2	121.5	99	1.8-3.8	0.4-1	SPINNING
S82ML	2.49	2	128.0	102	1.8-3.8	0.4-1	SPINNING
S86ML	2.59	2	133.0	104	1.8-3.8	0.4-1	SPINNING
S810ML	2.69	2	138.0	106	1.8-3.8	0.4-1	SPINNING
S92ML+	2.79	2	143.0	107	1.8-3.8	0.4-1	SPINNING
S79M	2.36	2	121.5	100	2-4	0.5-1	SPINNING
S82M	2.49	2	128.0	104	2-4	0.4-1	SPINNING
S86M	2.59	2	133.0	107	2-4	0.5-1	SPINNING
S90M	2.74	2	140.5	108	2-4	0.5-1	SPINNING
S86MH	2.59	2	133.0	107	2.5-4.5	0.6-1.2	SPINNING

## Sephia XTUNE MB

The latest technology is compact. The uncompromising performance further expands the possibilities of Eging.

Eging is actually in itself a wide field in the world of fishing. The target is not limited to only the big fin reef squid. The sizes can vary greatly depending on the species of squid. From shore to off-shores, from shallow to deep waters. The Sephia XR has a wide range of models to choose from regardless of the season.



※1 : S83ML, S86ML

SEPHIA XTUNE MB <span style="color: red;">NEW</span>							
Model Number	Rod Length [m]	No. of Sections	Closed Length [cm]	Weight [g]	Egi Size [no.]	Line Weight [PE]	Type
S83ML	2.51	5	53.6	53.6	1.8-3.8	0.4-1	SPINNING
S86ML	2.59	5	55.8	55.8	1.8-3.8	0.4-1	SPINNING
S86M	2.59	5	55.5	55.5	2-4	0.5-1	SPINNING



Sephia XTUNE S86MH

Sephia XTUNE MB S86M



Sephia XR S73SUL-S

Sephia SS S86ML-S

Sephia TT S86ML

## Sephia XR

Enjoy all kinds of squid fishing. Find your favourite model among our comprehensive lineup.

Eging is actually in itself a wide field in the world of fishing. The target is not limited to only the big fin reef squid. The sizes can vary greatly depending on the species of squid. From shore to off-shores, from shallow to deep waters. The Sephia XR has a wide range of models to choose from regardless of the season. Spiral X core gives the rods their light and strong blanks. The Carbon monocoque grip makes the rods lightweight and highly sensitive to nibbles from squids or small fishes. Finally, the X guide reduces line trouble. Using an array of technologies on the Sephia XR, Shimano is confident there is a right one for you!



**C14+**

※1 : S83L, S79ML, S83ML, S86ML

※2 : S73UL-S, S76UL-S, S86ML-S, S86M-S

SEPHIA XR							NEW
Model Number	Rod Length [m]	No. of Sections	Closed Length [cm]	Weight [g]	Egi Size [no.]	Line Weight [PE]	Type
S73SUL-S	2.21	2	114.0	89	1.5-2.5	0.2-0.5	SPINNING
S76UL-S	2.29	2	118.0	89	1.5-3	0.2-0.6	SPINNING
S83L	2.51	2	129.0	98	1.8-3.5	0.3-0.8	SPINNING
S79ML	2.36	2	121.5	96	1.8-3.8	0.4-1	SPINNING
S83ML	2.51	2	129.0	99	1.8-3.8	0.4-1	SPINNING
S86ML	2.59	2	133.0	100	1.8-3.8	0.4-1	SPINNING
S86ML-S	2.59	2	133.0	100	1.8-3.8	0.4-1	SPINNING
S86M	2.59	2	133.0	100	2-4	0.5-1	SPINNING
S86M-S	2.59	2	133.0	100	2-4	0.5-1	SPINNING
S73MH	2.21	2	114.0	96	2.5-4.5	0.6-1.2	SPINNING
S86MH	2.59	2	133.0	107	2.5-4.5	0.6-1.2	SPINNING
S90H	2.74	2	140.5	113	3-5	0.8-1.5	SPINNING

## Sephia SS

The SEPHIA SS rods exhibit a more natural bend and have an average weight of 95g across the lineup.



※1 : S83L, S86L ※2 : S76ML-S, S86ML-S, S86M-S

SEPHIA SS							
Model Number	Rod Length [m]	No. of Sections	Closed Length [cm]	Weight [g]	Egi Size [no.]	Line Weight [PE]	Type
S83L	2.51	2	129.0	92	1.5-3.5	0.3-0.8	SPINNING
S86L	2.59	2	133.0	92	1.5-3.5	0.3-0.8	SPINNING
S76ML	2.29	2	118.0	86	1.8-3.8	0.4-1	SPINNING
S76ML-S	2.29	2	118.0	87	1.8-3.8	0.4-1	SPINNING
S83ML	2.51	2	129.0	92	1.8-3.8	0.4-1	SPINNING
S86ML	2.59	2	133.0	93	1.8-3.8	0.4-1	SPINNING
S86ML-S	2.59	2	133.0	93	1.8-3.8	0.4-1	SPINNING
S89ML	2.67	2	137.0	95	1.8-3.8	0.4-1	SPINNING
S83M	2.51	2	129.0	92	2-4	0.5-1	SPINNING
S86M	2.59	2	133.0	99	2-4	0.5-1	SPINNING
S86M-S	2.59	2	133.0	102	2-4	0.5-1	SPINNING
S92M+	2.80	2	143.5	103	2-4.5	0.5-1	SPINNING
S86MH	2.59	2	133.0	102	2.5-4.5	0.6-1.2	SPINNING

## Sephia TT

The high performance rod Sephia TT emphasizes the ability to operate the most important technique - "jerk" in eging with a light and automatic feeling.

Designed so that the whole body of the rod bends flexibly, the rod jerks easily just by moving the wrist lightly. In addition, it is easy to grasp the timing of jerk and cast, establishing an intuitive "automatic" performance.



※1 : S83L, S86L

SEPHIA TT							
Model Number	Rod Length [m]	No. of Sections	Closed Length [cm]	Weight [g]	Egi Size [no.]	Line Weight [PE]	Type
S83L	2.51	2	129.0	96	1.5-3.5	0.3-0.8	SPINNING
S86L	2.59	2	133.0	96	1.5-3.5	0.3-0.8	SPINNING
S83ML	2.51	2	129.0	98	1.8-3.8	0.4-1	SPINNING
S86ML	2.59	2	133.0	98	1.8-3.8	0.4-1	SPINNING
S83M	2.51	2	129.0	98	2-4	0.5-1	SPINNING
S86M	2.59	2	133.0	105	2-4	0.5-1	SPINNING
S89M	2.67	2	137.0	107	2-4	0.5-1	SPINNING
S86MH	2.59	2	133.0	106	2.5-4.5	0.6-1.2	SPINNING

## Sephia BB

With Hi-Power X from the base of the blanks all the way to the tips, the SEPHIA BB cuts off unnecessary vibrations passed along the rod.



※1 : S83L, S86L

SEPHIA BB							
Model Number	Rod Length [m]	No. of Sections	Closed Length [cm]	Weight [g]	Egi Size [no.]	Line Weight [PE]	Type
S83L	2.52	2	129.4	99	1.5-3.5	0.3-0.8	SPINNING
S86L	2.59	2	133.2	102	1.5-3.5	0.3-0.8	SPINNING
S80ML	2.44	2	125.6	98	1.8-3.8	0.4-1	SPINNING
S83ML	2.52	2	129.4	100	1.8-3.8	0.4-1	SPINNING
S86ML	2.59	2	133.2	104	1.8-3.8	0.4-1	SPINNING
S80M	2.44	2	125.6	99	2-4	0.5-1	SPINNING
S83M	2.52	2	129.4	102	2-4	0.5-1	SPINNING
S86M	2.59	2	133.2	107	2-4	0.5-1	SPINNING
S89M	2.67	2	137.0	112	2-4	0.5-1	SPINNING
S86MH	2.59	2	133.2	113	2.5-4.5	0.6-1.2	SPINNING
S89MH	2.67	2	137.0	113	2.5-4.5	0.6-1.2	SPINNING

## Sephia XTUNE TIP EGING

A truly light rod to meet your eging expectations. Improving the performance on all fronts so you can continue eging all day long!

XTUNE is a thorough refinement of the performance required for tip-eging rods. Pursuing not only the lightness of its own weight, but also the "true lightness" of how it feels when used. Characteristics of these rods include being light, slender, responsive and having the strength of the butt unique to the XTUNE models. These are what will allow you as eging anglers to be able to use more aggressive and speedy jerk techniques on your egis, without the worry of the rod giving in to your unique style!



SEPHIA XTUNE TIP EGING							
Model Number	Rod Length [m]	No. of Sections	Closed Length [cm]	Weight [g]	Lure Weight [g]	Line Weight [PE]	Type
S68L-S	2.03	3	131.1	85	MAX40	0.3-0.8	SPINNING
S511ML-S	1.80	3	108.1	80	MAX60	0.4-1	SPINNING
S68ML-S	2.03	3	128.6	87	MAX60	0.4-1	SPINNING
S68M-S	2.03	3	131.6	90	MAX80	0.4-1	SPINNING

## Sephia C14+ TIP EGING

Introducing two additions to the line-up, the Sephia C14+ Tip Eging is now a more complete family with rods catering to a wider target range yet retains their sensitivity and operability.



※1 : S68L-S, S511ML-S, S68ML-S, S511M-S, S68M-S ※2 : S68MH-S

SEPHIA C14+ TIP EGING							
Model Number	Rod Length [m]	No. of Sections	Closed Length [cm]	Weight [g]	Lure Weight [g]	Line Weight [PE]	Type
S68L-S	2.03	2	170.9	95	MAX40	0.3-0.8	SPINNING
S511ML-S	1.80	2	147.9	90	MAX60	0.4-1	SPINNING
S68ML-S	2.03	2	168.4	95	MAX60	0.4-1	SPINNING
S511M-S	1.80	2	147.7	90	MAX80	0.4-1	SPINNING
S68M-S	2.03	2	168.4	100	MAX80	0.4-1	SPINNING
S68MH-S	2.03	2	168.2	100	MAX100	0.4-1	SPINNING

Sephia BB S86L

Sephia XTUNE TIP EGING S68ML-S

Sephia C14+ TIP EGING S68ML-S

Sephia SS TIP EGING S66ML-S



Sephia BB TIP EGING S66ML-S



## Sephia SS TIP EGING

With the whole family renewed, the latest centre cut Sephia SS Tip Eging rods have now achieved performance close to the C14+ family.



### SEPHIA SS TIP EGING

Model Number	Rod Length [m]	No. of Sections	Closed Length [cm]	Weight [g]	Lure Weight [g]	Line Weight [PE]	Type
S511ML-S	1.80	93.7	93.7	78	MAX60	0.4-1	SPINNING
S66ML-S	1.98	102.7	102.7	85	MAX60	0.4-1	SPINNING
S70ML-S	2.13	110.2	110.2	90	MAX60	0.4-1	SPINNING
S66M-S	1.98	102.7	102.7	87	MAX80	0.4-1	SPINNING
S70M-S	2.13	110.2	110.2	92	MAX80	0.4-1	SPINNING

## Sephia BB TIP EGING

With Hi-Power X at its core, this family of specialized tip eging rods have been equipped with the feature of a mid end rod.



※1 : S66ML-S, S70ML-S  
 ※2 : S66M-S, S70M-S

### SEPHIA SS TIP EGING







Model Number	Rod Length [m]	No. of Sections	Closed Length [cm]	Weight [g]	Lure Weight [g]	Line Weight [PE]	Type
S66ML-S	1.98	2	102.7	85	MAX60	0.4-1	SPINNING
S70ML-S	2.13	2	110.2	90	MAX60	0.4-1	SPINNING
S66M-S	1.98	2	102.7	88	MAX80	0.4-1	SPINNING
S70M-S	2.13	2	110.2	92	MAX80	0.4-1	SPINNING





**LIFESTYLE GEARS**

## Shimano Line Function

MATERIAL	PE LINE	CONSTRUCTION METHOD	PE LINE	
	<b>IZANAS®</b> This product uses ultra-high strength polyethylene fiber IZANAS®.		<b>X TOUGH CROSS</b> X Tough Cross incorporates a tight weave construction, which improves overall linear strength and knot strength. Another advantage is that it lowers elongation and heightens sensitivity, making it perfect for high end fishing.	
	<b>Spectra®</b> Uses Spectra's polyethylene raw yarn. A line with a thick fiber structure contained in the fiber bundle and excellent wear resistance. Spectra is recognised as the premium braided fishing line fibre. Spectra lasts twice as long in abrasion testing as comparable material.			<b>X TOUGH CROSS 2</b> The Tough Cross braiding method is now paired with the VT braiding method in the correct proportions to produce the latest evolution in line manufacturing. This evolution has yielded an unbelievable reliability which outs anglers at ease even when going up against sea monsters
	<b>X-Filament</b> Next-generation high-molecular-weight polyethylene yarn. The maximum requirement of "strong" required for PE lines has been greatly improved.			<b>EBT METHOD</b> Power Pro's Enhanced Body Technology [EBT] utilises original processing. The additional line treatment/ processing results in an overall improvement in line toughness, abrasion resistance, and fights line dig in comparison to Spectra line.

## OCEA8

NEW

X-Filament

HEATSINK COATING (45-13 only)

SALTWATER PE

Coated with a special silicon-resin material, the OCEA 8 lines are more resistant to heat. The best part is that the coating does not affect the lines' smoothness. With the use of the Tough Cross 2 technology and the VT construction method, these lines are stronger and more durable than ever!

Available in:

Breaking strength [lb]: 33, 45, 63, 76, 99, 113, 151, 173

Length: 200m, 300m, 400m, 500m

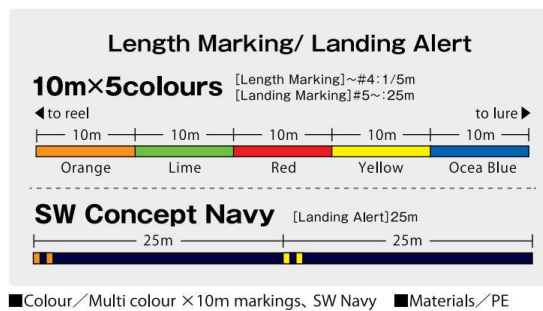
Multi colour  
SW Navy
 Made in Japan

## GRAPPLER8

NEW

IZANAS

HEATSINK COATING

World standard offshore PE Line!

The Grappler name has become synonymous with quality and strength and the new Grappler PE 8 carrier braid is no different. Sparing no cost, this multi colour PE Braid is made from 8 high-end IZANAS fibres and incorporates the Shimano exclusive Heat Sink technology that disperses heat across the coating, reducing damage to the line in those long, hard fights. The VT Construction Method enables the fine braid fibres to be woven evenly at all angles, under high tension. This results in a smoother finish and reduced diameter, which aids in all aspects of casting and jigging across PE 0.8 to PE 8.0.

Available in:

Breaking strength [lb]: 18.5, 23.1, 27.1, 31.0, 43.0, 63.0, 76.0, 98.2, 105.6, 147.7

Length: 200m, 300m

Strong retention rate of 94% after wear! (No. 0.8 / according to internal test)



Multi colour

 Made in Japan

## PITBULL 8+

IZANAS TOUGH CROSS 2 HEATSINK COATING

THE HIGHLY REPUTED [MISSION COMPLETE] EVOLVED INTO [PITBULL] SERIES!

Shimano Pitbull 8+ is very smooth, soft braided line with super low stretch. This new Plus version has Heat Sink Coating, silicone resin surface coating, which protects braided line from heat, especially from heat from abrasion.

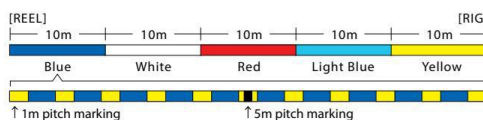
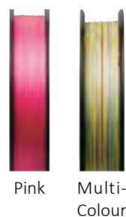
 Made in Japan



Pink  
Multi-Colour

Available in:

Breaking strength [lb]: 9.3lb, 12.2lb, 14.8lb, 18.5lb, 23.5lb, 27.1lb, 31.8lb, 43.0lb

Length: 150m, 200m

## PITBULL

IZANAS TOUGH CROSS 2 (PITBULL 12 ONLY)

Both suppleness and smoothness.  
PE line for ultra-low elongation lure casting.

Available in:

PITBULL 4

Breaking strength [lb]: 8.6lb, 10.3lb, 12.5lb, 17.8lb, 20.0lb, 27.0lb, 31.7lb, 38.7lb

Length: 150m, 200m, 300m

PITBULL 8

Breaking strength [lb]: 14.5lb, 18.3lb, 22.4lb, 27.0lb, 31.7lb, 42.8lb

Length: 150m, 200m, 300m

PITBULL 12

Breaking strength [lb]: 13.9lb, 18.3lb, 23.4lb, 28.4lb, 36.2lb, 43.7lb

Length: 150m, 200m

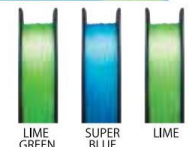
LIME GREEN  
SUPER BLUE  
LIME

 Made in Japan

# PITBULL 4+ NEW



Supple and low elongation.  
Super light PE line with excellent operability!

Available in:  
Weight [lb]: 4.5, 5.6, 7.1  
Length: 100m



Made in Japan

# Tanatoru ヨナトル



1m/5m with a simple colour pattern. Easy and convenient!

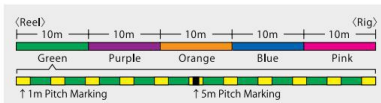

Available in:  
**Tanatoru 4**  
12.5lb, 17.8lb, 20.0lb, 31.7lb, 38.7lb, 49.1lb, 67.8lb  
150m, 200m, 300m, 500m

**Tanatoru 8**  
14.5lb, 18.3lb, 22.4lb, 31.7lb, 42.8lb, 54.6lb, 67.8lb,  
150m, 200m, 300m, 500m



Made in Japan

# 怪力 KAIRIKI MYSTERIOUS POWER

Kairiki 4 utilises the same VT Construction Method of braiding technology as Kairiki 8. Featuring four carriers, the new tight weave construction is created by applying high tension at opposing directions during the braiding process. The fibre is woven evenly at all angles, resulting in a smoother finish and a reduced diameter. This low stretch, long casting braid is an excellent choice for finesse fishing, where smoothness, sensitivity and castability is fundamental. Kairiki 4 is available from PE 0.6 (6lb) to PE 5 (50lb) in 150m and 300m spools, in Green and Multi colour.



Poundage	8lbs	10lbs	15lbs	20lbs	30lbs	40lbs	50lbs
Length	150m, 300m						
Colour	Mantis Green			Multi-Colour			

Made in Japan

# 怪力 KAIRIKI MYSTERIOUS POWER

Featuring 8 carriers and incorporating premium Japanese manufacturing, the new tight weave VT construction is created through applying high tension at opposing directions during the braiding process. In the VT Construction Method, fibre is woven evenly at all angles – resulting in a smoother finish, reduced diameter and longer casts.



• New advanced 8 carrier braid • High quality, made in Japan  
• Tight weave VT construction • Smoother finish - longer casting • Smoother finish - reduced noise

Poundage	8lbs	10lbs	15lbs	20lbs	30lbs	40lbs	50lbs	60lbs	80lbs
Length	150m, 300m & 3000m								
Colour	Mantis Green		Steel Gray		Hi-Viz Yellow		Multi-Colour		

Made in Japan

# Sephia 8+



TOUGH CROSS 2

HEAT-SINK COATING

Saltwater PE

Available in:

Breaking strength [lb]: MAX 8.6, 9.9, 14.5, 18.3

Length: 150m, 200m



DURABILITY UP 19%. WITH A RETENTION RATIO OF 0.4 EVEN AFTER ABRASION!

Made in Japan

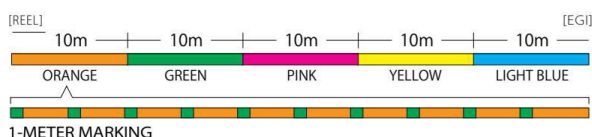

# Sephia 8



VT工法

Saltwater PE

- Made in Japan (Similar to Pitbull)
- Endorsed by experience instructors!
- Uses G5 colours for better squid hunting efficiency
- Relative density of 0.98 (Sephia 8 is floating type PE line)

Available in:  
Breaking strength [lb]:  
MAX 8.6, 9.9, 14.5, 18.3  
Length: 150m, 200m



A HIGHLY COST EFFECTIVE PE LINE WITH ENHANCED PERFORMANCE FOR EGING!

Made in Japan

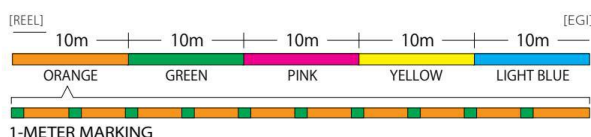

## OCEA JIGGER MX4

SALTWATER  
PE

Constructed using Melt Cross technology, the new OCEA Jigger MX4 is not only highly resistant to rubbing, it is also highly sensitive. With Melt Cross technology, the line is wrapped in a special film after braiding which is then heat-shrunk to melt the surface, making it more resistant than conventional braided lines.

Available in:

Breaking strength [lb] :

MAX 5lb, 12lb, 13lb, 19lb, 20lb, 35lb, 41lb, 52lb, 65lb

Length: 200m, 300m, 600m



Made in Japan



Conventional Braided Line

Melt Cross

Braided line produced by a new production process for overhead slow jigging

After braiding, the line is wrapped with a special film and heat-shrunk to melt the surface

## POWER PRO BOATGAME

With five contrasting colours, you get accurate casting and depth placement all the time. Giving you an added advantage over anglers who uses normal braids.

Available in:

Breaking strength [lb]:

10, 18, 20, 29, 33, 54, 67, 72, 92

Length: 150m, 200m, 300m

Easy-to-read color pattern marking at 1m &amp; 5m

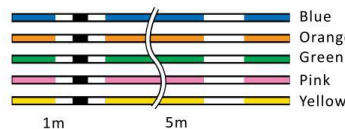
Blue  
Orange  
Green  
Pink  
Yellow

Spectra

日本編針

EBT

Made in USA



## POWER PRO SUPER SLICK V2

SuperSlick has been re-engineered for a whole new level of toughness. Combining a new 8-end, dense weave construction with the proven EBT coating process, SSV2 now delivers all of the smooth, silent benefits of original SuperSlick, plus added abrasion toughness that provides the power to rip through the heaviest cover with the same force as traditional 4-end braids. Available in traditional Blue, the popular Moss Green and now introducing Hi-Vis Aqua Green for the visibility minded angler, and Onyx for those looking to catch the monster Bass.

Available colours:



Available in:

Breaking strength [lb]: 8, 10, 15, 20, 30, 40, 50, 65, 80

Length: 150yd, 300yd, 500yd, 1500yd, 3000yd



Made in USA

## POWER PRO BRAIDED LINE

These super lines are a perfect combination when used together with Shimano tackles for the ultimate fishing experience. The Ultra-strong braided Spectra® Fiber was processed with the Enhanced Body Technology (EBT) to create an incredibly round, smooth & sensitive line. Power Pro outperforms mono-filament in any situation & leaves other super lines in the dust. Older, first-generation super lines were made of abrasive line that could cut rod guides and take a toll on equipment. PowerPro solves these problems through super slick, non-abrasive Spectra Fiber composition and unique EBT processing.

Available colours:



Available in:

Breaking strength [lb]: 3, 4, 5, 8, 10, 15, 20, 30, 40, 50, 65, 80, 100, 150, 200, 250

Length: 100yd, 150 yd, 300yd, 500yd, 1500yd, 3000yd



Made in USA

## EXAGE MONOFILAMENT LINE



- Good value all round monofilament mainline
- Exceptional knot strength
- Perfect for both freshwater and saltwater
- Made in Japan

Made in Japan

Available in:

Breaking strength [lb]: MAX 2.8lb, 3.9lb, 5lb, 6.3lb, 7.5lb, 9.7lb, 12.1lb, 16.5lb, 22.9lb, 28.4lb, 41.8lb

Length: 150m, 300m

## TECHNIUM INVISITEC MONOFILAMENT LINE



- A monofilament that is practically invisible in the water, helping it to blend into any lake bed
- Outstanding strength
- Superb casting properties
- Sinks quickly and stays on the bottom
- Made in Japan

Made in Japan

Available in:

Breaking strength [lb]: 4.8lb, 5.9lb, 7.2lb, 9.2lb, 11.6lb, 14.7lb, 19.8lb, 26.4lb, 33lb

Length: 150m

**OCEA** NEW  
**NYLON CASTING LEADER**

A blend of two types of high molecular weight nylon resin made in Japan. Achieves high strength with our unique spinning technology.



● Made in Japan

Shimano's OCEA Nylon Casting Leader is specifically designed for saltwater casting techniques. Powerful fish like giant trevally, kingfish and tuna can be harsh on hooks and terminal tackle and the inbuilt stretch and abrasion resistance of this premium high molecular weight monofilament leader minimises tackle failure. OCEA Nylon Casting Leader is also preferred for specialised topwater casting techniques to maintain a solid connection and hook-set under heavy drag settings.

Available in:

Breaking strength [lb]: 40, 50, 60, 70, 80, 90, 100, 120, 140, 170, 200, 260  
 Length: 30m, 50m

**OCEA**  
**OCEA JIGGER LEADER** Master Fluoro

Double layer construction. A thin line that catches big targets!

Ocea Jigger Master Fluoro is a leader line dedicated to jiggging that is reliable in extreme fights. Softer and higher shock absorbing performance than previous models.



● Made in Japan

Available in:

Breaking strength [lb]: MAX 16, 20, 25, 30, 40, 50, 60  
 Length: 50m

**OCEA**  
**FLUOROCARBON LEADER**

Unique two-layer structure with strong knots!

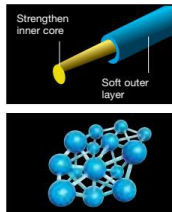

● Made in Japan

High Quality Fluorocarbon leader made to the highest spec in the market. Fluorocarbon is almost invisible in the water and has zero stretch. Special construction of a strength core with a soft outer layer means the line is easier to handle. Perfect pair up with the OCEA PE EX8.

Available in:

Breaking strength [lb]: 16lb, 20lb, 25lb, 30lb, 40lb, 50lb, 60lb, 80lb, 100lb  
 Length: 30m, 50m

**Sephia** **SHOCK LEADER** EGGING LEADER

A TENACIOUSLY STRONG YET FLEXIBLE FLUOROCARBON MADE SPECIALLY FOR EGI!

Available in:

Breaking Strength [lb]: MAX 7lb, 8lb, 10lb, 11lb, 14lb  
 Length: 30m



● Made in Japan

**EX FLUORO**

A NEW FLUOROCARBON LINE WHICH PROVIDES ANGLERS WITH A STRONG KNOT!

**HYPER REEL COATING**

WITH A SILICON COATING, THE LINE REPELS WATER MORE EFFECTIVELY!

**TUNED TO CUT WATER EFFECTIVELY**

THE STRETCH IN THE FC LINE IS PERFECT TO OPTIMISE THE ACTION OF THE ENTOURAGE EGI. IT ALSO HELPS TRANSFER ROD ACTION TO THE EGI!



LINE

PE (BRAIDED)

MONOFILAMENT

FLUOROCARBON

# BOOST CONCEPT

Shimano lures have the technology to dramatically improve the performance of lures, maximizing the potential of each lure.

Introducing the three (3) Boost Concepts. The Flash Boost appeals greatly to predators with the inner flashing plate (flashes even when lure is stationary). The Jet Boost stretches the casting distance of lures to the maximum and makes them immediately action-ready for retrieving right after landing onto the water surface. Lastly, the Scale Boost reproduces the scales of real sardines with refinement technology. The three boost concepts boosts your lures' performance like never before!

## FLASH BOOST

The mirror plate -  
A unique structure that keeps reflecting.

## JET BOOST

A center of gravity movement system  
that increases the flight distance.

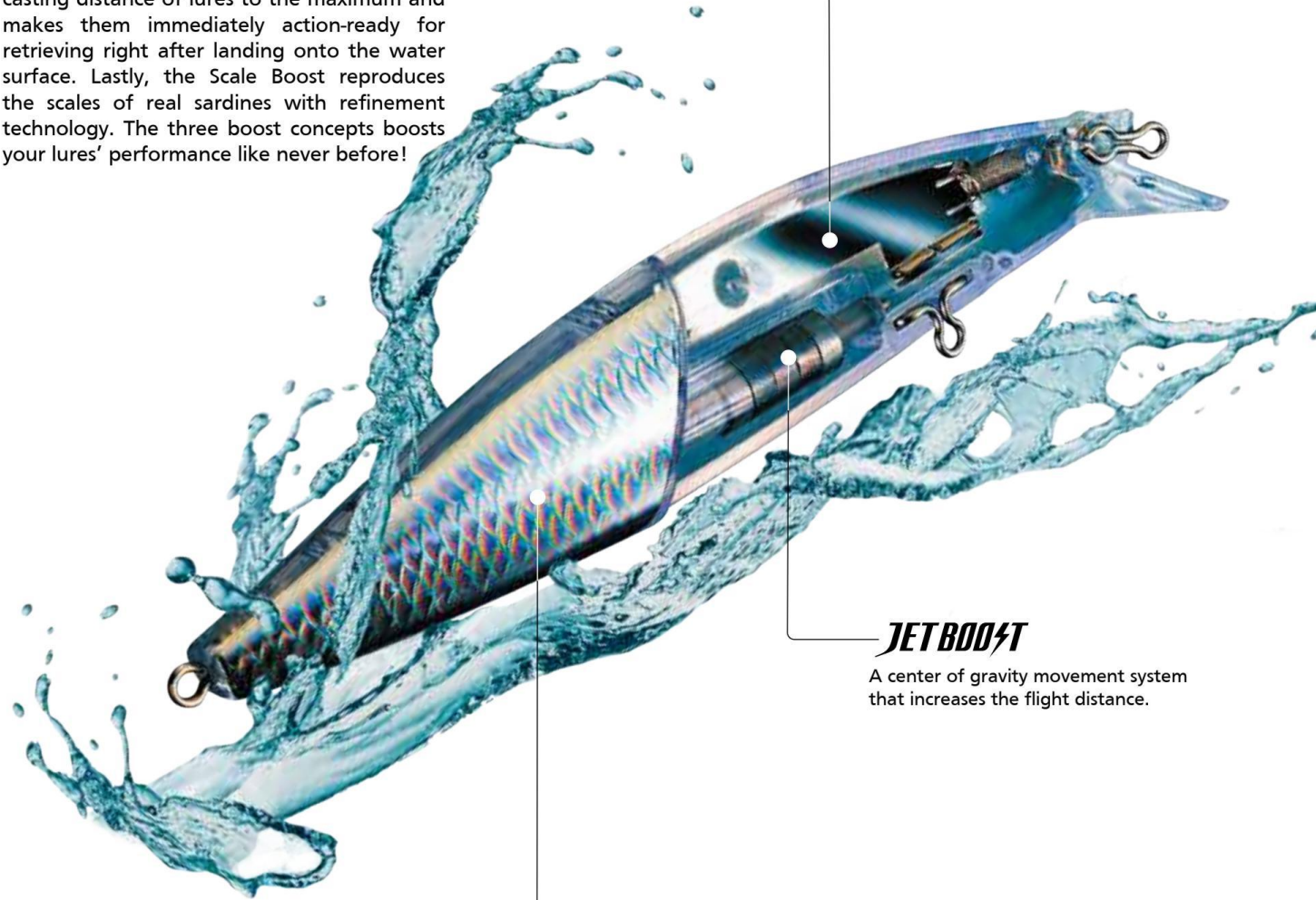

## SCALE BOOST

New hologram type color names N (Natural), A (Appeal), T (Transparent)

N(Natural)= Previously known as 狂鱗



"Natural", which reproduces real fish scales, pursues the reality that each scale shines independently. An original hologram with a sense of life.

A(Appeal)= Previously known as 強鱗



A hologram that follows the concept of "Natural" and enhances its presence by increasing the size of the scales, achieving both realism and appeal.

T(Transparent)=Previously known as : 透鱗



A hologram that follows the concept of "Appeal" and allows clear scales to shine, show through, and disappear, giving the fish a natural sense of life.



For more information on the Boost Concept:

[https://youtu.be/HLp\\_taOVib0](https://youtu.be/HLp_taOVib0)

Scan QR Code on the left with QR Code reader on your smartphone or tablet devices.

# Sephia *Entourage seagle* FLASHBOOST 3.5号

Introducing an evolved version of the Sephia Entourage - low underwater movement resistance and stable performance!

FLASHBOOST

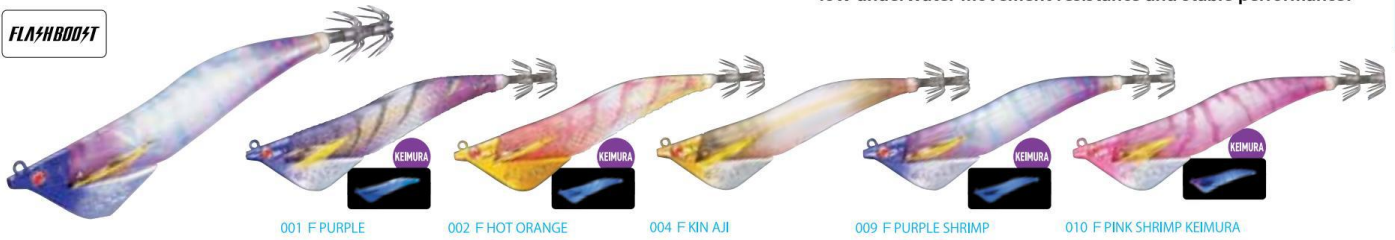

001 F PURPLE      002 F HOT ORANGE      004 F KIN AJI      009 F PURPLE SHRIMP      010 F PINK SHRIMP KEIMURA

## SEPHIA ENTOURAGE SEAGLE FLASH BOOST 3.5 **NEW**

Model	Length/ Weight	Colours
QT-X00U	3.5/25g	002, 003, 004, 009, 010
QT-X01U	3.5/28g	002, 003, 004, 009, 010
QT-X02U	3.5/35g	002, 003, 004, 009, 010
QT-X03U	3.5/43g	002, 003, 004, 009, 010

# Sephia *Clinch* FLASHBOOST

## No 2.5.3.0

FLASHBOOST



001 F MOTE MOTE PINK      002 F LIME BLUE      003 F PURPLE K      004 F AVOCADO K  
 005 F ELEGANT RED      006 F ORANGE CANDY      007 F GOLDEN HORSE MACKEREL      008 F KEIMURA SHRIMP      009 F BROWN SHRIMP  
 010 F BANANA CHATO      011 F PINK CHATO      012 F OYOGA SEA HORSE      013 F OYOGA SEIWA      014 F PINK CANDY

## SEPHIA CLINCH FLASH BOOST

Model	Size [No./] Weight	Colours
QE-X25T	2.5/10g	001, 002, 003, 004, 005, 006, 007, 008, 009, 010, 011, 012, 013, 014
QE-X30T	3.0/15g	001, 002, 003, 004, 005, 006, 007, 008, 009, 010, 011, 012, 013, 014

## No 3.5



001 F MOTE MOTE PINK      002 F LIME BLUE      003 F PURPLE K      004 F AVOCADO K  
 005 F KIN AJI      006 F KEIMURA SHRIMP      007 F BROWN SHRIMP      008 F OYOGA SEIWASHI      009 F PEACH SHRIMP      010 F MIKAN SHRIMP

## SEPHIA CLINCH FLASH BOOST 3.5

Model	Size [No./] Weight	Colours
QE-X35U	3.5/19g	001, 002, 003, 004, 005, 006, 007, 008, 009, 010

# Sephia *Clinch* Rattle



001 PINK GIN      002 ORANGE KIN      003 PINK CANDY      004 ORANGE CANDY      005 PINK CORE  
 006 AVOCADO KEIMURA      007 EGGPLANT PURPLE      008 BANANA CHATO      009 HAWAIIAN  
 010 TRI COLOUR      011 AJIIKEN      012 AJIAKA      013 KIBINAGO      014 GURUKUN KEIMURA

## SEPHIA CLINCH RATTLE

Model	Size [No./] Weight	Colours
QE-J25S	2.5/10g	001, 002, 003, 004, 005, 006, 007, 008, 009, 010, 011, 012, 013, 014
QE-J30S	3.0/15g	001, 002, 003, 004, 005, 006, 007, 008, 009, 010, 011, 012, 013, 014
QE-J35S	3.5/19g	001, 002, 003, 004, 005, 006, 007, 008, 009, 010, 011, 012, 013, 014
QE-J38S	3.8/24g	001, 002, 003, 004, 005, 006, 007, 008, 009, 010, 011, 012, 013, 014

LURE

FEATURES

EGGING

OFFSHORE

SHORE SALT

LIGHT SALT

ULTRA LIGHT

BASS

# Sephia Clinch

SEARCH AND HUNT MODEL

MONSTER BOTTOM MODEL



SEPHIA CLINCH 2.5/3.0/3.5/3.8

Model	Size [No./ Weight	Colours
<b>TYPE 1: SEARCH AND HUNT MODEL</b>		
QE-230Q	2.5/10g	01T, 02T, 03T, 04T, 05T, 06T, 07T, 08T, 09T, 10T, 11T, 12T, 13T, 14T, 15T, 16T, 17T, 18T, 19T, 20T
QE-225Q	3.0/15g	
<b>TYPE 2: MONSTER BOTTOM MODEL</b>		
QE-238Q	3.5/19g	01T, 02T, 03T, 04T, 05T, 06T, 07T, 08T, 09T, 10T, 11T, 12T, 13T, 14T, 15T, 16T, 17T, 18T, 19T, 20T
QE-235Q	3.8/24g	

# Sephia SUI SUI DROPPER

FLASHBOOST

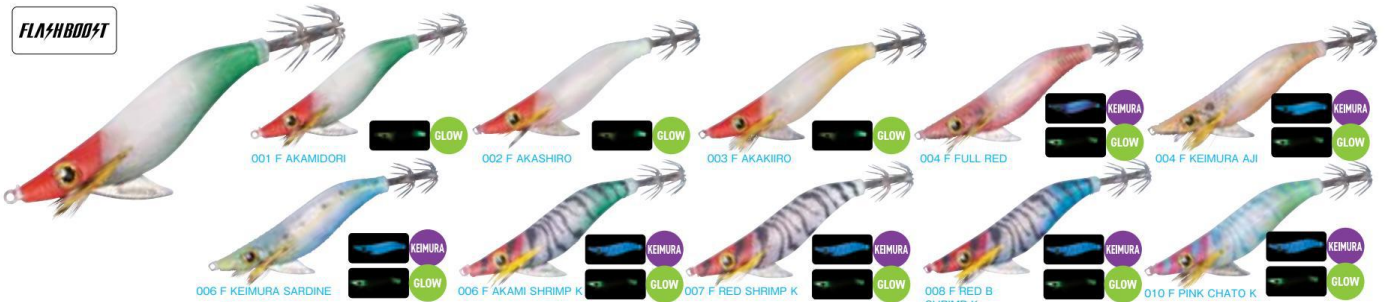

SEPHIA SUI SUI DROPPER 2.5 **NEW**

Model	Size [No./ Weight	Colours
QS-X25U	2.5/ 6.5g	001, 002, 003, 004, 005, 006, 007, 008, 009, 010

# OCEA BOMB DIP 170F FLASHBOOST

FLASHBOOST

JETBOOST

SCALEBOOST



Designed for aggressive surface feeding predators, the Ocea Bomb Dip Flash Boost is a powerful popper designed for both inshore and offshore fishing.

When aggressive fish like tuna and GT are feeding near the surface, few lures beat a popper for action and the Ocea Bomb Dip is no exception. From your very first cast you'll notice how the Jet Boost technology powers the lure through the air; reaching distances you thought weren't achievable, which is useful when tuna are pack feeding away from your boat.



Reduces popping mistakes. Uses a gourd-shaped body for the purpose of improving operability.

A gourd-shaped body that has good tide biting and can realize popping with a short movement distance. Since it is easy to get entangled with water, we are also aiming to reduce misactions such as lures rolling on the surface of the water. In addition to a small body that attracts attention with loud popping and is easy to eat, it is equipped with a flash boost that keeps flushing even while the lure action is stopped.



A deep cup design that realizes deep bass and loud volume and a bubble chamber that draws a large amount of bubbles into the water are fused.

A bubble chamber that takes in water and air and draws finely sparkling bubbles into the water. A deep cup design designed for loud popping sounds that are difficult to achieve with small poppers.



OCEA BOMB DIP 170F FLASH BOOST **NEW**

Model	Length/ Weight	Colours
XU-P17V	170mm/72g	001, 002, 003, 004, 005, 006



## OCEA BUBBLE DIP 220F FLASHBOOST

Equipped with a flash boost on the bubble dip!  
A slim popper that has evolved to aim for tuna!

FLASHBOOST

JETBOOST

SCALEBOOST



"Flash Boost Mechanism" Continue to flash even when it stays in place!



Supports single hook aimed at amberjack and GT

Triple hooks

Single hook



Attract with bubbles!



001 F SARDINE



003 F ANCHOVY



005 F GREEN

GREEN PLATE



007 T SARDINE



002 F PINK SARDINE



004 F FLYING FISH



006 F RAINBOW

GREEN PLATE



008 A ORANGE

### OCEA BUBBLE DIP 220F FLASH BOOST **NEW**

Model	Length/ Weight	Colours
XU-P22T	220mm/93g	001, 002, 003, 004, 005, 006, 007, 008

## OCEA BUBBLE DIP 180F JETBOOST

JETBOOST

SCALEBOOST



001 KYORIN IWASHI



002 KYORIN PINK



004 KYORIN FLYING FISH



006 TOURIN IWASHI



02T SILHOUETTE SAURY



04T SILHOUETTE CLEAR SILVER

### OCEA BUBBLE DIP 180F JET BOOST **NEW**

Model	Length/ Weight	Colours
OP-118R	180mm/76g	001, 002, 004, 006, 02T, 04T

## OCEA HEAD DIP 175F / 200F FLASHBOOST

FLASHBOOST

JETBOOST

Unstoppable flashing!  
Head Dip with Flash Boost!

SCALEBOOST



175mm

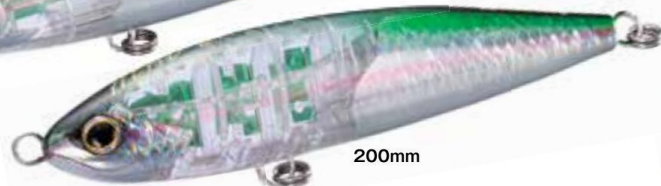

200mm



001 F SARDINE



002 F PINK SARDINE



003 F ANCHOVY



004 F FLYING FISH



005 F ALUMINUM SARDINE



006 F ALUMINUM SAURY



007 F GREEN

GREEN PLATE



008 F RAINBOW

GREEN PLATE

### OCEA HEAD DIP 175F / 200F FLASH BOOST

Model	Length/ Weight	Colours
XU-T17T	175mm/ 97g	001, 002, 003, 004, 005, 006, 007, 008
XU-T20S	200mm/ 135g	001, 002, 003, 004, 005, 006, 007, 008

## OCEA HEAD DIP 140F FLASHBOOST

FLASHBOOST

JETBOOST

SCALEBOOST



The low buoyancy design allows the entire lure to be immersed in water as much as possible, and the Flash Boost continues to shine, giving it a strong appeal that will not be interrupted during the stay.



### FLASH BOOST MECHANISM

The vibration amplification by the spring keeps the plate flashing even when it is stationary.



003 F ANCHOVY



005 F RAINBOW

GREEN PLATE



001 F SARDINE



004 F FLYING FISH



002 F PINK SARDINE



007 F GREEN

GREEN PLATE



006 F RAINBOW



007 T SARDINE



008 A ORANGE

### OCEA HEAD DIP 140F FLASH BOOST **NEW**

Model	Length/ Weight	Colours
XU-T14U	140mm/ 70g	001, 002, 003, 004, 005, 006, 007, 008

## OCEA SARDINE BALL 130S FLASH BOOST

FLASH BOOST

JET BOOST

A sardine ball aimed at yellowfin tuna!

SCALE BOOST



Continue to appeal even if it is moving or stationary. Equipped with Flash Boost.

Equipped with a large hook to confront tuna!



### OCEA SARDINE BALL 130S FLASH BOOST **NEW**

Model	Length/ Weight	Colours
XU-S13U	130mm/ 77g	001, 002, 003, 004, 005, 006, 007, 008

## OCEA SARDINE BALL 150S FLASH BOOST

FLASH BOOST

JET BOOST

Shimano has finally applied the unstoppable flashing effect onto the OCEA Sardine Ball, sinking pencils made specifically to target Tunas!

SCALE BOOST



### OCEA SARDINE BALL 150S FLASH BOOST **NEW**

Model	Length/ Weight	Colours
XU-S15S	150mm/ 71g	001, 002, 003, 004, 006, 007, 008, 009

## OCEA FULL THROTTLE 190F JET BOOST

JET BOOST

Unstoppable! Keep rolling! Introducing a downsized model that is easy to handle with full throttle that supports non-stop jerk.

SCALE BOOST

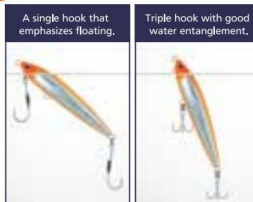
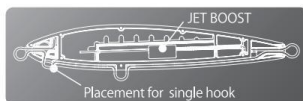

### OCEA FULL THROTTLE 190F FLASH BOOST **NEW**

Model	Length/ Weight	Colours
XU-T19V	190mm/ 85g	001, 002, 003, 004, 006

## OCEA 列注平政 220F FLASH BOOST

Fine tune with good water entanglement. The new weight makes it even easier to handle.

FLASH BOOST

SCALE BOOST



**FLASH BOOST**  
A flash boost mechanism that hangs a reflector inside the body with a spring. By using vibration such as rod action and amplifying the vibration with a spring, you can continue to appeal with quick glittering flashing even during drifting without moving the lure.



### OCEA BETCHU HIRAMASA 160 F FLASH BOOST **NEW**

Model	Length/ Weight	Colours
XU-T22U	220mm/ 120g	001, 002, 003, 004, 006

# OCEA 列注平政 160F FLASHBOOST

FLASHBOOST SCALEBOOST



Shimano's original Flash Boost is installed in the Betchu Hiramasa!

Compared to the original model Ocea Pencil Betchu Hiramasa 160F, it is equipped with a newly designed weight laid out at the rear center of gravity, and the posture during stay is adjusted in the upright direction. This tuning makes it easier to restore the posture after jerk, and it is designed with the aim of reducing dive mistakes and improving the stability in waters.

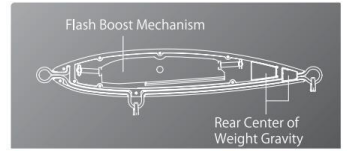

## "Flash Boost Mechanism"

Vibration amplification by spring keeps inviting even when stationary



001 F SARDINE

002 F PINK SARDINE

003 F ANCHOVY

004 F FLYING FISH

005 F WHITE

006 F ORANGE

### OCEA BETCHU HIRAMASA 160F FLASH BOOST

Model	Length/ Weight	Colours
XU-B16U	160mm/ 61g	001, 002, 003, 004, 006

# OCEA PENCIL 列注平政 145F / 160F / 190F / 220F

SCALEBOOST



145mm

001 KYORIN SARDINE

006 KYORIN KATAKUCHI

007 KYORIN FLYING FISH

008 KYORIN ORANGE

010 TOURIN IWASHI

011 BOAT WHITE

### OCEA PENCIL BETCHU HIRAMASA 145F/160F/190F/220F **NEW**

Model	Length/ Weight	Colours
OT-145K	145mm/46g	001, 006, 007, 008, 010, 011
OT-160J	160mm/57g	001, 006, 007, 008, 010, 011
OT-190J	190mm/70g	001, 006, 007, 008, 010, 011
OT-022L	220mm/114g	001, 006, 007, 008, 010, 011

# OCEA Pebble Light A slim slender jig which falls beautifully and naturally!

SCALEBOOST



## 'Snap' Connection Method Quick Change Assist

A 'snap' connection method is used while maintaining strength so that small hooks used in super light jiggling can be replaced quickly.

A pebble light designed to imitate the slow falling of a weak bait so that it can be 'eaten' without discomfort. Not only is the pebble stick smaller, but the balance is also adjusted with an emphasis on operability.



001 KYORIN GURIKIN

002 KYORIN CHATO

003 KYORIN ZEBRA

004 KYORIN PINK

005 KYORIN SARDINE

006 KYORIN AKAKIN

007 KEIMURA BAIT

008 KYORIN OREKIN

### OCEA PEBBLE LIGHT

Model	Length/ Weight	Colours
JU-P40U	92mm/40g	001, 002, 003, 004, 006, 007, 008
JU-P60U	105mm/60g	001, 002, 003, 004, 006, 007, 008
JU-P80U	125mm/80g	001, 002, 003, 004, 006, 007, 008

# OCEA Wing Fall Wide horizontal roll, light pull resistance and fast landing. 'Teardrops' that have been sharpened to accommodate all fish species.

SCALEBOOST



001 ZEBRA GLOW

004 PLATED COPPER

005 KYORIN SILVER

008 FULL GLOW

003 KYORIN AKAKIN

002 FULL SILVER

005 KYORIN BP

007 KYORIN MURAGIN

A thin head that creates light pull resistance for comfortable operability even in the deep sea.

Flat side that falls while rolling in a wide horizontal posture.

Equipped with a newly designed weight laid out at the rear center of gravity allows for quick landing.



### OCEA WING FALL

Model	Length/ Weight	Colours
JV-F80T	88mm/80g	001, 002, 003, 004, 006, 007, 008
JV-F10T	95mm/100g	001, 002, 003, 004, 006, 007, 008
JV-F13T	104mm/130g	001, 002, 003, 004, 006, 007, 008
JV-F16T	111mm/160g	001, 002, 003, 004, 006, 007, 008
JV-F20T	118mm/200g	001, 002, 003, 004, 006, 007, 008
JV-F25T	127mm/250g	001, 002, 003, 004, 006, 007, 008
JV-F33T	133mm/330g	001, 002, 003, 004, 006, 007, 008
JV-F37T	138mm/370g	001, 002, 003, 004, 006, 007, 008
JV-F40T	142mm/400g	001, 002, 003, 004, 006, 007, 008
JV-F50T	154mm/500g	001, 002, 003, 004, 006, 007, 008

LURE

FEATURES

AGING

OFFSHORE

SHORE SALT

LIGHT SALT

ULTRA LIGHT

BASS

# OCEA Long Waver

SCALEBOOYT

## SIZE CHART

100g  
130g  
160g  
200g  
250g  
290g  
320g  
350g  
400g  
500g



### OCEA LONG WAVER **NEW**

Model	Length/ Weight	Colours
JV-L10U	138mm/100g	001, 002, 003, 004, 006, 007, 008, 009, 010
JV-L13U	151mm/130g	001, 002, 003, 004, 006, 007, 008, 009, 010
JV-L16U	162mm/160g	001, 002, 003, 004, 006, 007, 008, 009, 010
JV-L20U	175mm/200g	001, 002, 003, 004, 006, 007, 008, 009, 010
JV-L25U	191mm/250g	001, 002, 003, 004, 006, 007, 008, 009, 010
JV-L29U	202mm/290g	001, 002, 003, 004, 006, 007, 008, 009, 010
JV-L32U	215mm/320g	001, 002, 003, 004, 006, 007, 008, 009, 010
JV-L35U	217mm/350g	001, 002, 003, 004, 006, 007, 008, 009, 010
JV-L40U	246mm/400g	001, 002, 003, 004, 006, 007, 008, 009, 010
JV-L50U	271mm/500g	001, 002, 003, 004, 006, 007, 008, 009, 010

# OCEA Stinger Butterfly Sardine Waver

SCALEBOOYT

From groupers and snappers to Tunas and GTs, this series of pilot jigs is more than ready with new additional sizes in the lineup!



### OCEA STINGER BUTTERFLY SARDINE WAVER 100g-250g

Model	Length/ Weight	Colours
JT-410P	111mm/100g	009, 010, 011, 012, 013, 01T, 06T, 52T
JT-413P	121mm/130g	009, 010, 011, 012, 013, 01T, 06T, 52T
JT-416P	130mm/160g	009, 010, 011, 012, 013, 01T, 06T, 52T
JT-418P	135mm/180g	009, 010, 011, 012, 013, 01T, 06T, 52T
JT-420P	140mm/200g	009, 010, 011, 012, 013, 01T, 06T, 52T
JT-425P	151mm/250g	009, 010, 011, 012, 013, 01T, 06T, 52T

### OCEA STINGER BUTTERFLY SARDINE WAVER 290g-500g

Model	Length/ Weight	Colours
JV-S29T	168mm/290g	001, 002, 004, 005, 006, 007, 008, 009
JV-S32T	174mm/320g	001, 002, 004, 005, 006, 007, 008, 009
JV-S35T	178mm/350g	001, 002, 004, 005, 006, 007, 008, 009
JV-S40T	189mm/400g	001, 002, 004, 005, 006, 007, 008, 009
JV-S50T	204mm/500g	001, 002, 004, 005, 006, 007, 008, 009

# OCEA Stinger Butterfly Easy Pebble

Comfortable to retrieve, easy-to-perform long slide actions and dynamic rolling of the jigs during fall actions!



### OCEA STINGER BUTTERFLY EASY PEBBLE

Model	Length/ Weight	Colours
JV-C10S	144mm/100g	001, 002, 003, 004, 005, 006, 008, 009, 011
JV-C14S	162mm/140g	001, 002, 003, 004, 005, 006, 008, 009, 011
JV-C17S	174mm/170g	001, 002, 003, 004, 005, 006, 008, 009, 011
JV-C21S	188mm/210g	001, 002, 003, 004, 005, 006, 008, 009, 011
JV-C25S	199mm/250g	001, 002, 003, 004, 005, 006, 008, 009, 011
JV-C29S	209mm/290g	001, 002, 003, 004, 005, 006, 008, 009, 011
JV-C32S	216mm/320g	001, 002, 003, 004, 005, 006, 008, 009, 011
JV-C35S	224mm/350g	001, 002, 003, 004, 005, 006, 008, 009, 011
JV-C40S	233mm/400g	001, 002, 003, 004, 005, 006, 008, 009, 011
JV-C50S	250mm/500g	001, 002, 003, 004, 005, 006, 008, 009, 011
JV-F70T	259mm/700	001, 002, 003, 004, 005, 006, 008, 009, 011
JV-F90T	277mm/900	001, 002, 003, 004, 005, 006, 008, 009, 011

# OCEA Stinger Butterfly Pebble Stick

SCALEBOOST

Pebble stick, a jig that invites reaction with a quick fall.



## OCEA STINGER BUTTERFLY PEBBLE STICK

Model	Length/ Weight	Colours
JT-908N	125mm/80g	001, 002, 003, 004, 006, 007, 008, 009, 24T, 36T
JT-910N	135mm/100g	001, 002, 003, 004, 006, 007, 008, 009, 24T, 36T
JT-912N	143mm/120g	001, 002, 003, 004, 006, 007, 008, 009, 24T, 36T
JT-915N	154mm/150g	001, 002, 003, 004, 006, 007, 008, 009, 24T, 36T
JT-920N	170mm/200g	001, 002, 003, 004, 006, 007, 008, 009, 24T, 36T
JT-926N	185mm/260g	001, 002, 003, 004, 006, 007, 008, 009, 24T, 36T
JT-930N	195mm/300g	001, 002, 003, 004, 006, 007, 008, 009, 24T, 36T
JT-935N	205mm/350g	001, 002, 003, 004, 006, 007, 008, 009, 24T, 36T

# OCEA Stinger Butterfly Center Sardine

SCALEBOOST

A series of center jigs suited for milder jiggling motions to target bait fish!



## OCEA STINGER BUTTERFLY CENTER SARDINE **NEW**

Model	Length/ Weight	Colours
JT-709L	108mm/90g	001, 002, 003, 004, 005, 006, 25T
JT-711L	115mm/110g	001, 002, 003, 004, 005, 006, 25T
JT-713L	123mm/135g	001, 002, 003, 004, 005, 006, 25T
JT-716L	130mm/160g	001, 002, 003, 004, 005, 006, 25T

# OCEA Stinger Butterfly Wing

SCALEBOOST



## OCEA STINGER BUTTERFLY WING

Model	Length/ Weight	Colours
JT-511M	98mm/110g	001, 002, 003, 004, 005, 15T, 25T
JT-513M	105mm/135g	001, 002, 003, 004, 005, 006, 25T
JT-516M	112mm/160g	001, 002, 003, 004, 005, 006, 25T
JT-520M	120mm/200g	001, 002, 003, 004, 005, 006, 25T, 36T
JT-525M	129mm/250g	001, 002, 003, 004, 005, 006, 25T, 36T

# OCEA Stinger Butterfly Drift Slasher NORTH PREMIUM

SCALEBOOST



## OCEA STINGER BUTTERFLY DRIFT SLASHER NORTH PREMIUM

Model	Length/ Weight	Colours
JU-D15U	173mm/150g	001, 002, 003, 004
JU-D20U	190mm/200g	001, 002, 003, 004
JU-D24U	202mm/240g	001, 002, 003, 004

# OCEA Stinger Butterfly King Slasher Pilot jigs targeted at Tunas and Amberjacks

SCALEBOOST



## OCEA STINGER BUTTERFLY KING SLASHER **NEW**

Model	Length/ Weight	Colours
JT-312P	171mm/120g	001, 010, 011, 012, 013, 014
JT-313P	178mm/135g	001, 010, 011, 012, 013, 014
JT-315P	184mm/150g	001, 010, 011, 012, 013, 014
JT-318P	195mm/180g	001, 010, 011, 012, 013, 014
JT-320P	203mm/200g	001, 010, 011, 012, 013, 014
JT-324P	215mm/240g	001, 010, 011, 012, 013, 014

LURE

FEATURES

EGING

OFFSHORE

SHORE SALT

LIGHT SALT

ULTRA LIGHT

BASS

OCEA *Stinger Butterfly* **Speed Slasher**

**Speed Slasher**

Deep waters? Fast currents? Perfect for the Speed Slasher to come on scene! Now with additional colours!

SCALEBOOST



OCEA STINGER BUTTERFLY SPEED SLASHER **NEW**

Model	Length/ Weight	Colours
JT-215Q	189mm/150g	001, 011, 012, 01T, 09T, 10T
JT-218Q	201mm/180g	001, 011, 012, 01T, 09T, 10T
JT-220Q	208mm/200g	001, 011, 012, 01T, 09T, 10T
JT-224Q	221mm/240g	001, 011, 012, 01T, 09T, 10T
JT-230Q	238mm/300g	001, 011, 012, 01T, 09T, 10T

OCEA **Assist Hook Set**

Based off the design of self-made hooks by one of Shimano's instructors. A set of hooks which generally covers all sorts of jigging styles!



OCEA HOOKS WITH SPECIAL CASE



Set Includes: **BAITCAST / OVERHEAD JIGGING FOR MID-DEEP WATERS**

TWIN S	TWIN M	TWIN L
×4 SETS	×4 SETS	×4 SETS
HOOK: #3/0	HOOK: #3/0	HOOK: #3/0

Set Includes: **BAITCAST / OVERHEAD JIGGING FOR IN-SHORE SCENES**

TWIN S	TWIN M	TWIN L
×4 SETS	×4 SETS	×4 SETS
HOOK: #2/0	HOOK: #2/0	HOOK: #2/0

Set Includes: **JIGGING WITH SPINNING REELS**

TWIN S	TWIN M	SINGLE L
×3 SETS	×3 SETS	×3 SETS
HOOK: #5/0	HOOK: #5/0 THICK	HOOK: #9/0

OCEA ASSIST HOOK SET

Model	TYPE
EU-K03S	BAITCAST/ OVER HEAD JIGGING [IN-SHORE]
EU-K02S	BAITCAST/ OVERHEAD JIGGING [ MID-DEEP WATER]
EU-J03S	JIGGING WITH SPINNING REELS

**BEAM POPPER 130F FLASHBOOST**

Average flight distance over 70m?! Birth of a slim popper for surf with flash boost!

FLASHBOOST JETBOOST SCALEBOOST

BODY DESIGN



The mirror plate held by a spring inside the body synchronizes with the lure action to create diffuse reflection. Even while the action is stopped and drifting, the plate inside shines for a while and invites the fish.

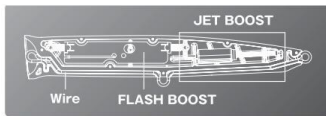

NESSA BEAM POPPER 130F FLASH BOOST **NEW**

Model	Length/ Weight	Colours
XG-P13U	130mm/29g	001, 002, 003, 004, 005, 006, 007, 008, 009, 010

COLTSNIPER **ROCKFLAT 150S JETBOOST**

Action changes between topwater and underwater according to the cranking or winding technique of the angler!

JETBOOST SCALEBOOST

Luring in even the more stubborn species which do not bite, this fits your Slow Jigging needs perfectly!



COLTSNIPER ROCKFLAT 150S JET BOOST

Model	Length/ Weight	Colours
XX-S15S	150mm/67g	001, 002, 003, 004, 005, 007, 009, 010

## COLTSNIPER ROCKSPLASH 140F JETBOOST

JETBOOST SCALEBOOST



COLTSNIPER ROCKSPLASH 140F JET BOOST

Model	Length/ Weight	Colours
OT-140Q	140mm/68g	001, 010, 013, 014, 015, 016, 017, 018

## COLTSNIPER ROCKWALK 110F Luring fish with a diving and skating lure of smaller shapes is the Coltsniper Rock Walk

SCALEBOOST



COLTSNIPER ROCKWALK 110F

Model	Length/ Weight	Colours
OT-111Q	110mm/23g	001, 010, 013, 014, 015, 016, 017, 018

## COLTSNIPER ROCKDIVE 160F JETBOOST Incredible casting distances with the centre of gravity shifting system. S-shaped diving and sliding patterns created from the keel mouth design on the Coltsniper Rock Dive!

JETBOOST SCALEBOOST



COLTSNIPER ROCKDIVE 160F JET BOOST

Model	Length/ Weight	Colours
OT-160P	160mm/65g	001, 010, 013, 014, 015, 016, 017, 018

## COLTSNIPER ROCKSLIDE 120S / 140S JETBOOST

JETBOOST

SCALEBOOST



COLTSNIPER ROCKSLIDE 120S/ 140S JET BOOST

Model	Length/ Weight	Colours
OL-212P	120mm/33g	001, 010, 013, 014, 015, 016, 017, 018
OL-214P	140mm/56g	001, 010, 013, 014, 015, 016, 017, 018

## COLTSNIPER アオモノキャッチャー

SCALEBOOST



COLTSNIPER AOMONO CATCHER

Model	Length/ Weight	Colours
JW-228S	71mm/28g	001, 002, 003, 004, 005, 006, 007, 008, 009, 010
JW-235S	78mm/35g	001, 002, 003, 004, 005, 006, 007, 008, 009, 010
JW-242S	85mm/42g	001, 002, 003, 004, 005, 006, 007, 008, 009, 010
JW-260S	91mm/60g	001, 002, 003, 004, 005, 006, 007, 008, 009, 010

LURE

FEATURES

AGING

OFFSHORE

SHORE SALT

LIGHT SALT

ULTRA LIGHT

BASS

## COLTSNIPER サコシジグ

SCALE BOOST



## COLTSNIPER SAGOSHI

Model	Length/ Weight	Colours
JW-L28T	105.5mm/28g	001, 002, 003, 004, 005, 006, 007
JW-L35T	105.5mm/35g	001, 002, 003, 004, 005, 006, 007
JW-L42T	109.5mm/42g	001, 002, 003, 004, 005, 006, 007

## COLTSNIPER WONDERFALL

Fascinating fall action aiming at various fish species!

SCALE BOOST



## COLTSNIPER WONDERFALL

Model	Length/ Weight	Colours
JM-503Q	58mm/30g	001, 002, 003, 004, 44T, 45T, 47T
JM-504Q	66mm/40g	001, 002, 003, 004, 44T, 45T, 47T
JM-505Q	72mm/50g	001, 002, 003, 004, 44T, 45T, 47T
JM-506Q	77mm/60g	001, 002, 003, 004, 44T, 45T, 47T

## Soare Metal shot TG

Metal Shot TG with new colours!



Hooks are not included for 18g-40g

SOARE METAL SHOT TG **NEW**

Model	Weight	Colours
JJ-T03U	3g	001, 002, 003, 004, 005, 006, 007
JJ-T05U	5g	001, 002, 003, 004, 005, 006, 007
JJ-T07U	7g	001, 002, 003, 004, 005, 006, 007
JJ-T10U	10g	001, 002, 003, 004, 005, 006, 007
JJ-T14U	14g	001, 002, 003, 004, 005, 006, 007
JJ-T18U	18g	001, 002, 003, 004, 005, 006, 007
JJ-T24U	24g	001, 002, 003, 004, 005, 006, 007
JJ-T32U	32g	001, 002, 003, 004, 005, 006, 007
JJ-T40U	40g	001, 002, 003, 004, 005, 006, 007

EXSENCE Silent Assassin 99F / 99S / 99SP **FLASH BOOST**

FLASH BOOST

JET BOOST

All-rounder minnow in any situation! Assassin 99 with flash boost is born!

SCALE BOOST

EXSENCE SILENT ASSASSIN 99F/ 99S/ 99SP FLASH BOOST **NEW**

Model	Length/ Weight	Colours
XM-199V	99mm/14g	001, 002, 003, 004, 005, 006, 007, 008
XM-299V	99mm/17g	001, 002, 003, 004, 005, 006, 007, 008
XM-999V	99mm/16g	001, 002, 003, 004, 005, 006, 007, 008



## EXSENCE Dive Assassin 99F / 99S *FLASHBOOST*

FLASHBOOST

JETBOOST

Introducing a diving minnow dive assassin with excellent flight distance!

SCALEBOOST



004 F RED HEAD



002 F BORA



003 F SUKE IWASHI



005 F CANDY



006 F TOURIN IWASHI



007 F CHATO GOLD



008 F GURIKIN

EXSENCE DIVE ASSASSIN 99F / 99S FLASH BOOST **NEW**

Model  
XM-D99U  
XM-E99U

Length/ Weight  
99mm/16g  
99mm/19g

Colours

001, 002, 003, 004, 005, 006, 007, 008  
001, 002, 003, 004, 005, 006, 007, 008

## Bantam WorldRush 56F *FLASHBOOST*

FLASHBOOST



001 BLACK CHATO



002 GOLD CHATO



003 BLACKBUCK S



004 NATURAL GIL



005 SEXY G SHAD



006 RED CLAW



007 GREEN CLAW



008 GREEN CHATO S  
GOLD PLATE



009 BROWNBACK S  
GOLD PLATE



010 BLUE CHATO

BANTAM WORLD RUSH 56F FLASH BOOST **NEW**

Model  
ZQ-C56V

Length/ Weight  
56mm/16g

Colours

001, 002, 003, 004, 005, 006, 007, 008, 009, 010

## Bantam World Diver 99SP *FLASHBOOST*

Stable flight distance and continuous appeal underwater!

FLASHBOOST

JETBOOST

SCALEBOOST



001 KYORIN KUROGIN



002 KYORIN KUROKIN



003 KYORIN CHATO



004 KYORIN SMELT



005 KYORIN CROWN



006 KYORIN BLUE



007 KYORIN RED



008 HOT TIGER



009 SMELT



010 TOURIN AYU  
GOLD PLATE

BANTAM WORLD DIVER 99SP FLASH BOOST **NEW**

Model  
ZQ-B99U

Length/ Weight  
99mm/16g

Colours

001, 002, 003, 004, 005, 006, 007, 008, 009, 010

## Bantam World Minnow 115F *FLASHBOOST*

A floating model has been added to the proven World Minnow 115!

FLASHBOOST

JETBOOST

SCALEBOOST



001 KYORIN KUROGIN



002 KYORIN KUROKIN



003 KYORIN CHATO



004 KYORIN SMELT



011 KYORIN CROWN



013 KYORIN BLUE



014 KYORIN RED



015 HOT TIGER



016 SMELT



017 TOURIN AYU  
GOLD PLATE

BANTAM WORLD MINNOW 115F FLASH BOOST **NEW**

Model  
ZQ-M11U

Length/ Weight  
115mm/14g

Colours

001, 002, 003, 004, 011, 014, 015, 016, 017

## Scorpion WORLD JERK 115F / 115S *FLASHBOOST*

Cross the boundaries of lure fishing!  
Jerk bait for multiple fish species!

FLASHBOOST

JETBOOST

SCALEBOOST



004 A CHATO G  
GOLD PLATE



001 N FLORIDA  
GOLD PLATE



002 N ORANGE CHART  
GOLD PLATE



003 N RED GORUDO  
GOLD PLATE



005 N PINK SILVER



006 MATTE OSBORNE



007 MATTE BLACK



008 T CHATO PEARL

SCORPION WORLD JERK 115F / 115S FLASH BOOST **NEW**

Model  
ZR-M11V  
ZR-311V

Length/ Weight  
115mm/16g  
115mm/19g

Colours

001, 002, 003, 004, 005, 006, 007, 008  
001, 002, 003, 004, 005, 006, 007, 008

LURE

FEATURES

EGGING

OFFSHORE

SHORE SALT

LIGHT SALT

ULTRA LIGHT

BASS

# PANZAR EX POPPER 65



## BUBBLE CHAMBER

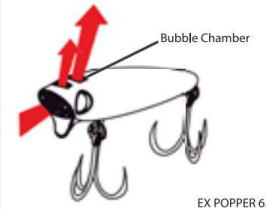

The 'Bubble Chamber' will force water through the chamber and shoot it out of the top creating more commotion than conventional poppers.

PANZAR EX POPPER 65

Model	Length	Colours
XHT66SE	65mm	001, 002, 003, 004, 005, 006, 007, 008, 009, 010, 011, 012

# PANZAR EX PENCIL 75



## EASY SLIDE ACTION



Easy to use and achieve great casting distance with "Magnet Weight Transfer System"!

## MAGNET WEIGHT TRANSFER SYSTEM

Improve casting distance and swimming response.

Casting-Move Weight (improve casting distance)

Swimming-Fix weight (improve swimming response)

PANZAR EX PENCIL 75

Model	Length	Colours
XHT75SE	75mm	001, 002, 003, 004, 005, 006, 007, 008, 009, 010, 011, 012

# PANZAR EX MINNOW 70F/S



## COMBINATION OF STRONG WOBBLE AND ROLL ACTION



PANZAR EX MINNOW 70F/S

Model	Length	Colours
ZN170S	70mm	001, 002, 003, 004, 005, 006, 007, 008, 009, 010, 011, 012
ZNM70S	70mm	001, 002, 003, 004, 005, 006, 007, 008, 009, 010, 011, 012

# APPAREL SIZE CHART

## MEN

NEW SIZING								
MEASUREMENT	XS	S	M	L	XL	2XL	3XL	4XL
HEIGHT (cm)	155~165	160~170	165~175	170~180	175~185	175~185	175~185	175~185
CHEST (cm)	80~88	84~92	88~96	92~100	96~104	100~108	104~112	108~116
WAIST (cm)	66~74	70~78	74~82	78~86	82~90	86~94	90~98	94~102
HIPS (cm)	82~90	86~94	90~98	94~102	98~106	102~110	106~114	110~118

OLD SIZING								
MEASUREMENT	XS	S	M	L	XL	2XL	3XL	4XL
HEIGHT (cm)	145~155	150~160	160~170	170~180	175~185	180~190	185~195	190~200
CHEST (cm)	72~80	78~86	84~92	90~98	96~104	102~110	111~125	121~135
WAIST (cm)	60~68	66~74	72~80	78~88	86~96	94~104	105~115	114~124

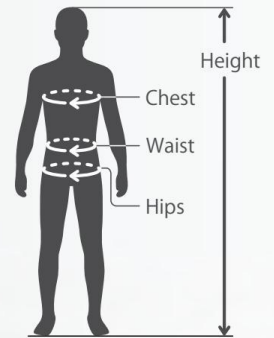

## LADIES

NEW SIZING								
MEASUREMENT	—	WS	WM	WL	—	—	—	—
HEIGHT (cm)	—	150~160	155~165	160~170	—	—	—	—
CHEST (cm)	—	76~84	80~88	84~92	—	—	—	—
WAIST (cm)	—	56~64	60~68	64~72	—	—	—	—
HIPS (cm)	—	82~90	86~94	90~98	—	—	—	—

OLD SIZING								
MEASUREMENT	—	—	WM	—	—	—	—	—
HEIGHT (cm)	—	—	150~160	—	—	—	—	—
CHEST (cm)	—	—	80~86	—	—	—	—	—
WAIST (cm)	—	—	60~70	—	—	—	—	—

- ※ The size is displayed on the back tag.
- ※ The displayed size chart is a guide. Please be sure to try it on when you purchase and select the appropriate size.
- ※ The new size is applicable for models that ends with "V". (Example: RA-001V)

## FEATURES



### Water Repellent

It is a product that has the effect of reducing the penetration of water into the fabric by repelling water in the form of water droplets on the surface of the fabric by applying special processing.



### Breathable

It is a product that has the function of letting water vapor from sweat escape to the outside of clothes, suppressing the generation of moisture and water droplets inside clothes, and reducing stuffiness and stickiness of the skin. This feature helps maintain a comfortable fit when working in the rain or wearing it for extended periods of time.



### UPF50+

It is a product that has UPF50+ Sun Protection, which is the highest value when the cut rate is 95% or more in the world standard of UV blocking performance. When worn, the time affected by UV rays can be delayed by 50 times or more compared to when the skin is bare.



### UV Cut

It is a product with the added function of effectively blocking harmful ultraviolet rays and reducing sunburn. Products with this UV cut mark protect the skin from UV rays and help prevent sunburn effectively.



### Water Absorption & Quick Drying

This product uses a fabric that has the function of quickly absorbing and releasing moisture when the product gets wet or sweats. This feature keeps the skin dry and provides a silky feel.



### Stretch

It is a product that uses a fabric with elasticity. It is soft to the touch and does not interfere with the movement of arms, legs, and joints, so it is not easy to feel stress. In addition to a comfortable fit that fits the body line, it also has the convenience of being easily removed.



### Waterproof

Assuming wearing in rainy weather or in an environment where it is splashed with water, the fabric has been waterproofed to prevent water from penetrating from the front to the back, and the seam tape treatment for waterproof sewing has cleared the total waterproofness test.



A classic design with brand logo  
**ORGANIC COTTON LOGO T-SHIRT**

**SH-004V** NEW  
 • Organic cotton that is soft to the touch  
 • Accented with a simple brand logo  
 AVAILABLE SIZES:  
 WS, WM, XS, S, M, L, XL, 2XL



A comfortable T-shirt that absorbs water, block UV rays, and dries quickly.  
**QUICK-DRYING GRAPHIC T-SHIRT**

**SH-005V** NEW  
 • Lightweight and durable recycled polyester  
 • Various graphics created for each color  
 AVAILABLE SIZES:  
 WS, WM, XS, S, M, L, XL, 2XL



A full zip shirt that absorbs water and dries quickly, making it comfortable even on a sunny day.  
**PRINTED FULL ZIP SHIRT**

**SH-006V** NEW  
 • Adopts a full zip with excellent detachability  
 • Sporty print design  
 AVAILABLE SIZES:  
 XS, S, M, L, XL, 2XL



## SOUTH EAST ASIA FISHING WEAR



**WATER CAMO BLUE HOODIE** NEW  
 AVAILABLE SIZES:  
 S, M, L, XL, 2XL, 3XL



**SHIMANO GRAY HOODIE** NEW  
 AVAILABLE SIZES:  
 S, M, L, XL, 2XL, 3XL



**SUBLIMATED LONG SLEEVE TEE** NEW  
 AVAILABLE SIZES:  
 S, M, L, XL, 2XL, 3XL



**OUT OF OFFICE TEE** NEW  
 AVAILABLE SIZES:  
 S, M, L, XL, 2XL, 3XL



**SHIMANO BASIC TEE**  
 AVAILABLE SIZES:  
 S, M, L, XL, 2XL, 3XL



**IT'S ALL ABOUT THE BASS TEE**  
 AVAILABLE SIZES:  
 S, M, L, XL, 2XL, 3XL



**FEROCIOUS GROUPER TEE**  
 AVAILABLE SIZES:  
 S, M, L, XL, 2XL, 3XL



**LIVE.BREATHE.FISH HOODIE**  
 AVAILABLE SIZES:  
 S, M, L, XL, 2XL, 3XL



**WHITE CAMO HOODIE**  
 AVAILABLE SIZES:  
 S, M, L, XL, 2XL, 3XL



Shorts with a design suitable for casual wear.

**DRY SHORTS**

**WP-000V** *NEW*

- Wrinkle-resistant fabric
- Buckle belt that can be attached and detached with one touch
- Wide range of motion, inseam gusset

AVAILABLE SIZES:  
WS, WM, XS, S, M, L, XL, 2XL



Pants suitable for casual wear

**DRY PANTS**

**WP-001V** *NEW*

- Wrinkle-resistant fabric
- Buckle belt that can be attached and detached with one touch
- Wide range of motion, inseam gusset

AVAILABLE SIZES:  
WS, WM, XS, S, M, L, XL, 2XL



Shorts with a stylish three-dimensional silhouette.

**ACTIVE PROOF SHORTS**

**WP-002V** *NEW*

- Buckle belt that can be attached and detached with one touch
- Belt specifications make it difficult to slip off

AVAILABLE SIZES:  
WS, WM, XS, S, M, L, XL, 2XL



Active pants with a three-dimensional silhouette.

**ACTIVE PROOF PANTS**

**WP-003V** *NEW*

- Buckle belt that can be attached and detached with one touch
- Belt specifications make it difficult to slip off

AVAILABLE SIZES:  
WS, WM, XS, S, M, L, XL, 2XL



A face mask that feels soft to the touch and has high elasticity, making it easy to breathe.

**FACE MASK**

**AC-001V** *NEW*

- Adopts punching process that makes it easy to breathe
- Equipped with an ear hook loop to prevent slipping off
- We devised a sewing method for wearing comfortability

FREE SIZE



It has high texture and elasticity and is well ventilated.

**SUNSHADE**

**AC-002V** *NEW*

- Provides good ventilation, use with a cap to prevent sunburn
- Adjustable by opening and closing the snap button

FREE SIZE



Highly textured and stretchable!  
Comfortable fit.

**ARM COVER**

**AC-004V** *NEW*

- Size:  
S: Upper arm circumference 25-30cm, total length 47cm  
M: Upper arm circumference 27-32 cm, total length 47 cm



Highly textured and stretchable!  
Comfortable fit.

**LEG COVER**

**AC-005V** *NEW*

- Size: M: Thigh circumference 45-52 cm, total length 64.6 cm  
L: Thigh circumference 45-52 cm, total length 74.6 cm





KHAKI

WHITE

NAVY YELLOW



POISON BLUE

BLACK RED

BLUE CAMO



RED

YELLOW CAMO

DEEP NAVY



KHAKI CAMO



Light fishing shoes with excellent sliding resistance.

**EVAIR MARINE FISHING SHOES**

**FS-0911**

One shoe for all your aqua-activity needs. Made from non-marking rubber outsole using ultralight EVA material, the Shimano EVAIR sandals is made for the outdoors. One piece molded EVA absorbs heel shock and reduces foot fatigue with its ergonomic arch design. Now in new colors to suit your preference.

AVAILABLE SIZES: 7-13



Gray Camo

Yellow Green

Marine Camo

Light fishing sandals with excellent sliding resistance.

**EVAIR MARINE FISHING SANDALS**

**FS-093L**

AVAILABLE SIZES: 7-13



FORCEMASTER

LESATH

BASSTERRA

CRUZAR

PANZAR

JIGWREX

STRADIC

BEASTMASTER

**SHIMANO EYEWEAR**

FREE SIZE



BLACK

CHARCOAL

BLUE

KHAKI



Basic design rain work cap.

**RAIN WORK CAP**

**CA-001V** **NEW**

AVAILABLE SIZES: S, M, L



BLACK

CHARCOAL

NAVY

BLUE

Basic design silhouette cap.

**TWILL CAP**

**CA-007V** **NEW**

AVAILABLE SIZES: S, M, L



BLACK

KHAKI

NAVY

GRAY

Basic design silhouette mesh cap.

**TWILL MESH CAP**

**CA-008V** **NEW**

AVAILABLE SIZES: S, M, L



OCEAN NAVY

BLACK

Basic gloves with a new generation pattern design.

**OCEA BASIC GLOVES**

**GL-003V** **NEW**

AVAILABLE SIZES: S, M, L, XL



OCEAN NAVY

BLACK

Flagship gloves that can withstand harsh use.

**OCEA TOUGH GLOVES**

**GL-001V** **NEW**

AVAILABLE SIZES: S, M, L, XL



BLACK

KHAKI

GRAY

A hip bag that fits snugly and does not slip easily.

**HIP BAG**

**BW-021T** **NEW**

•Material: Polyester

AVAILABLE SIZES:

•S: 10×29×17cm

•M: 12×32×22cm



BLACK

KHAKI

GRAY

Shoulder bag that can be hung on either side.

**SLING SHOULDER BAG**

**BS-025T** **NEW**

•Material: Polyester

AVAILABLE SIZES:

•S: Fits 2 boxes (21 x 15 x 4 cm)

•M: Fits 4 boxes (21 x 15 x 4 cm)



BLACK

KHAKI

GRAY

A shoulder bag that fits snugly on your shoulder.  
**SHOULDER BAG**

- BS-021T** NEW
- Material: Polyester
  - AVAILABLE SIZES:
  - One size: 10×32×22cm

SHIRT



BLACK

GRAY

WITH RAIN COVER

SAND BEIGE

Comes with a rain cover.  
 A mini shoulder bag that is easy to use for fishing.  
**MINI SHOULDER BAG**

- BS-026U** NEW
- Material: Polyester
  - AVAILABLE SIZES:
  - One size: 7.5×25×18cm

PANTS

INNER WEAR

FOOT WEAR



LW

S

RW

R

Egi case.  
**SEPHIA EGI CASE**

- BP-221S** NEW
- Material: Polypropylene
  - AVAILABLE SIZES:
  - S: 4.5x13x18cm (Fits up to 8 egis)
  - R: 4x21x15cm (Fits up to 14 egis)
  - L: 4.5x25x18cm (Fits up to 18 egis)
  - SW: 7x13x18cm (Fits up to 18 egis)
  - RW: 7x 21x15cm (Fits up to 28 egis)
  - LW: 7x25x18cm (Fits up to 36 egis)
  - Storage guide is based on egi size no. 3.5

OTHERS

BAGS/ CASE



M

M

L

L

Reels can be stored systematically.  
**REEL POUCH**  
**PC-029R**

- AVAILABLE SIZES:
- M: 19×28×13cm
  - L: 31×41×16.5cm
- Storage guide:
- M: 3x C3000 size reels+2x 5000 size reels
  - L: 4x 10000 size reels+ 3x 20000 size reels

TOOLS



## HD TACKLE BOX

Robust body with storability  
Tackle box that can also be used as a chair



### HD TACKLE BOX 47

CS-202U **NEW**

DIMENSION:  
• 46.5×33.3×32.2cm

Light and strong! Robust body!

Although it has a light body that is easy to carry, it can be used as a chair with a load capacity of 500 kg.



### HD TACKLE BOX 50

CS-201U **NEW**

DIMENSION:  
• 53.8×35.9×34.7cm

Partitioned tray box convenient for storage!

A removable tray that can store necessary items such as lures. With a partition, small items can be stored efficiently.



HD Tackle Box 47/ 50 includes 1x free Hammerhead Shark Motif sticker inside.

- Water resistant
- UV resistant
- For tackle boxes and coolers



BLACK 22L



KHAKI 27L



GRAY 22L

### ROD REST BOAT BAG (HARD)

BK-007T **NEW**

• Material: EVA

AVAILABLE SIZES/ DIMENSIONS:

- 22L OUTER: 30×38×30cm, INNER: 27×36×8cm
- 27L OUTER: 30×45×30cm, INNER: 27×42×8cm
- 32L OUTER: 30×52×30cm, INNER: 27×50×8cm



BLACK 22L



KHAKI 27L



GRAY 22L



BLACK 27L



GRAY 27L

A classic tackle boat bag (with inner tray).

### TACKLE BOAT BAG (HARD)

BK-001T **NEW**

• Material: EVA

AVAILABLE SIZES/ DIMENSIONS:

- 22L OUTER: 30×38×30cm, INNER: 27×36×8cm
- 27L OUTER: 30×45×30cm, INNER: 27×42×8cm

A classic tackle boat bag (without inner tray).

### EVA TACKLE BAG (HARD)

BK-002T **NEW**

• Material: EVA

AVAILABLE SIZES/ DIMENSIONS:

- 22L OUTER: 30×38×30cm
- 27L OUTER: 30×45×30cm



TH-202N  
Heavy



BLACK GOLD

OCEA BLUE

Compatible with bobbin knots. A high-strength knot can be created by easily wrapping the PE line around the leader.

### BOBBIN WINDER HEAVY

TH-202N

- Size / 75mm
- Weight / 57g
- PE compatible (1.5-8.0 recommended)

AVAILABLE COLOUR  
• BLACK GOLD  
• OCEA BLUE

TH-201M  
Light



NAVY

RED

BLACK

### BOBBIN WINDER LIGHT

TH-201N

- Size: 75mm
- Weight: 33g
- PE compatible (0.3-3.0 recommended)

AVAILABLE COLOUR  
• NAVY  
• RED  
• BLACK

RUST RESISTANT  
Fluorine Processing  
COMPATIBLE RINGS  
#5~#11  
STRAIGHT



BLACK

LIGHT GRAY

KHAKI

RUST RESISTANT  
Fluorine Processing  
COMPATIBLE RINGS  
#5~#11  
BEND



BLACK

LIGHT GRAY

Offshore pliers that support up to large split rings.

### POWER PLIERS [OFFSHORE]

CT-561P **NEW**

- Size: 185 x 50 x 16 mm
- Blade Material: Stainless steel

• Lock part that can be opened and closed with one hand  
• Handle shape / material (soft) for ease of grip  
• Lanyard mounting hole  
• PE line compatible

AVAILABLE COLOURS:

- BLACK
- LIGHT GRAY
- KHAKI

### POWER PLIERS

CT-562P **NEW**

- Size: 185 x 50 x 16 mm
- Blade Material: Stainless steel

• Easy to work with a curved tip  
• Lock part that can be opened and closed with one hand  
• Handle shape and material (soft) that pursues ease of grip  
• Lanyard mounting holes  
• PE line compatible

AVAILABLE COLOURS:

- BLACK
- LIGHT GRAY
- KHAKI

RUST RESISTANT  
Fluorine Processing  
COMPATIBLE RINGS  
#00~#3



BLACK

KHAKI

BLACK

KHAKI

For light games, trout, bass, etc.

### MINI RING PLIERS TYPE-F

CT-544P **NEW**

- Size: 120x46x13mm
- Blade Material: Stainless steel

• Easy-to-grip handle shape  
• Sleeve caulking  
• Handle end lock  
• Lanyard mounting hole  
• Compatible with PE line

AVAILABLE COLOURS:

- BLACK
- KHAKI

### MINI RING PLIERS

CT-545P **NEW**

- Size: 120x46x13mm
- Blade Material: Stainless steel

• Easy-to-grip handle shape  
• Sleeve caulking  
• Handle end lock  
• Lanyard mounting hole  
• Compatible with PE line

AVAILABLE COLOURS:

- BLACK
- KHAKI

RUST RESISTANT  
Fluorine Processing  
COMPATIBLE RINGS  
#1~#5



BLACK

LIGHT GRAY

KHAKI

For sea bass, flounder, jigging, etc.

### AD PLIERS RH TYPE-F

CT-541P **NEW**

- Size: 158x48x13mm
- Blade Material: Stainless steel

AVAILABLE COLOUR

- BLACK
- LIGHT GRAY
- KHAKI

• Easy-to-grip handle shape  
• Lock part that can be opened and closed with one hand  
• End rope / lanyard mounting hole  
• Sleeve caulking  
• Lure eye tuner  
• PE line compatible

COMPATIBLE RINGS  
#1~#5

### AD PLIERS RH TYPE-F

CT-542P **NEW**

- Size: 158x48x13mm
- Blade Material: Stainless steel

AVAILABLE COLOUR

- BLACK
- KHAKI

• Easy-to-grip handle shape  
• Lock part that can be opened and closed with one hand  
• End rope / lanyard mounting hole  
• Sleeve caulking  
• Lure eye tuner  
• PE line compatible



BLACK

KHAKI

Please follow the instructions below to grease fully assembled reels.

**IMPORTANT:** Grease in a proper position for best results.

● **OILING POINTS**

 : OIL ONLY

 : OIL OR GREASE

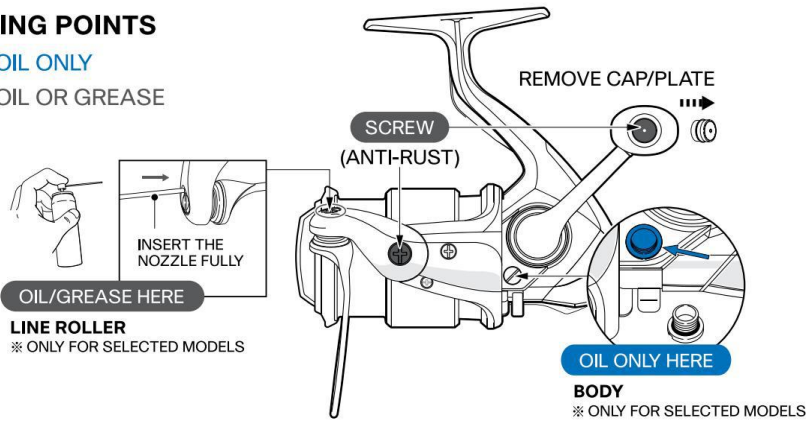

※ ONLY USE GREASE WHEN REEL IS DISASSEMBLED

● **OIL/GREASE POINTS FOR SPINNING REEL**

 : OIL ONLY

 : GREASE ONLY

 : OIL OR GREASE

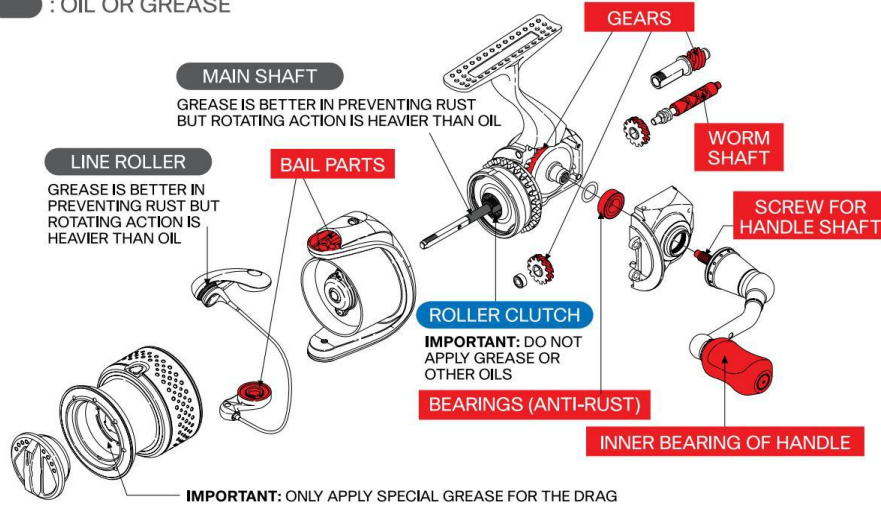

IMPORTANT: ONLY APPLY SPECIAL GREASE FOR THE DRAG

● **OIL/GREASE POINTS FOR BAITCAST REEL**

 : OIL ONLY

 : GREASE ONLY

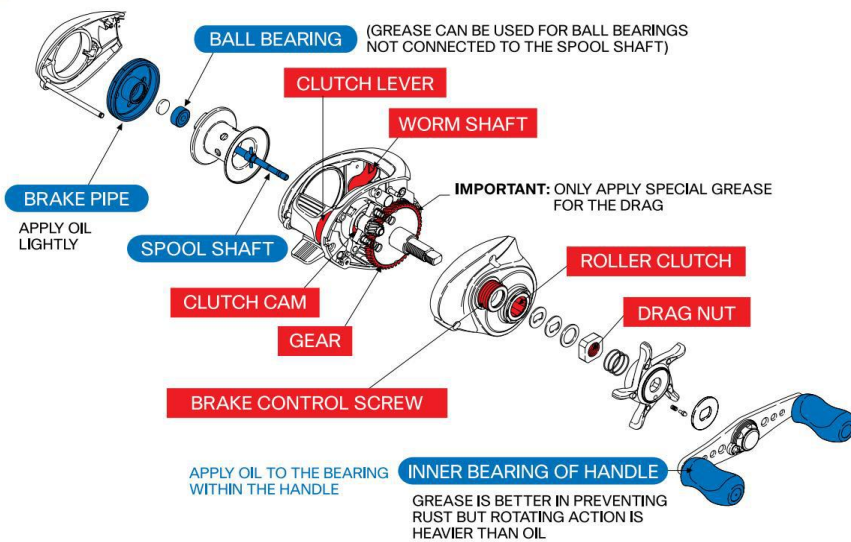

< ATTENTION >  
APPLY OIL/GREASE IN SUITABLE PORTIONS FOR PROPER FUNCTIONING OF REEL  
DISASSEMBLE REEL AT YOUR OWN RISK

REEL  
OIL  
GREASE  
SPRAY  
INSTRUCTION

REEL MAINTENANCE  
SPRAY



SP-013A

SP-213A

SHIMANO



## AM I COVERED BY SHIMANO WARRANTY?

Check out our dealer locator for your nearest Shimano Authorised Dealer to be covered under our warranty! Enquire more in stores for details on the warranty coverage. Terms and conditions apply.



SCAN HERE FOR OUR DEALER LOCATOR!  
Available on both our website and Facebook page.

**AUTHORISED  
WARRANTY PRODUCT**



# SHIMANO

## **SHIMANO (S) PTE LTD**

20 Benoi Sector, Jurong Town,  
Singapore 629852  
[fish.shimano.com.sg](http://fish.shimano.com.sg)

## **SHIMANO INC.**

3-77 Oimatsu-cho, Sakai-Ku,  
Sakai City, Osaka 590-8577  
[fishing.shimano.co.jp](http://fishing.shimano.co.jp)

## **COPYRIGHT 2022 SHIMANO (SINGAPORE) PTE LTD.**

All rights reserved. Nothing in this publication may be reproduced in whole or in part, by any means, without the expressed permission from Shimano (Singapore) Pte Ltd. All specifications listed here are subjected to change without prior notice.

Shimano (Singapore) Pte Ltd. handles Shimano Tackles Sales to countries in South East Asia and South Asia through our authorized distributors, wholesalers and dealers.

🌐 [fish.shimano.com.sg](http://fish.shimano.com.sg)     **ShimanoFishSEA**

