



okuma
INSPIRED FISHING

**2022-2023
PRODUCT CATALOG**

INSPIRED FISHING

OKUMA FISHING TACKLE RISING WITH EVERY CHALLENGE

The average person might stumble upon a remote beach & find inspiration in the texture of the sand, curl of the waves & the salty spice of the air. For the community of anglers, however, playing witness to nature is far less satisfying than direct participation.

As we approach every piece of water, our attention inevitably falls to what lies beneath the surface: beneath the waves, off the point, on the edge of structure, at the intersection of currents. It's the fish & their habits, their power & speed that captivate our attention. Through rod & reel we find our connection. Some call it sport. We call it a way of life that's rich with experiences.

At Okuma Fishing Tackle, our goal is to enhance every encounter. Integrating the latest advancements in materials & construction techniques is a means to downplay the presence of the gear. Eliminate weight & increase feel. Enjoy a running fish instead of fearing it. Button down the drag & go toe-to-toe with complete confidence. Your focus is not on the equipment; it's on the fish.

Wherever your travels take you, from the local pond to distant reef, we're proud to be your partner in the discovery of what lies beneath.

OKUMA FISHING TACKLE CORPORATION



CONTENTS

1 SPINNING REELS

Makaira Spinning Reels	16
Tesoro Spinning Reels	17
Salina Salt Reels	18
Cedros Reels	19
Azores Saltwater Reels	20
ITx Carbon Reels	21
SURF-8k Reels	22
Rockaway Surf & Baitfeeder Reels	22
Coronado CDX Baitfeeder Reels	23
Helios SX Reels	23
CEYMAR HD REELS	24
Epixor XT Reels	24
Ceymar Reels	25
Ceymar Baitfeeder Reels	25
Ceymar ODT Reels	26
Avenger Reels	27
Avenger Baitfeeder Reels	28
Alaris Reels	29
Rox Reels	29
Fina spin reels	30
Aria "a" Reels	30

2 BAITCAST REELS

Hakai DT Low Profile Baitcast	34
Komodo SS Low Profile Baitcast	37
Citrix Low Profile Baitcast	38
Ceymar ODT Baitcast Reels	38
Serrano Low Profile Baitcast	39
Epixor Low Profile Baitcast	40
Halogen Low Profile Baitcast	40
Ceymar Low Profile Baitcast	40

3 CONVENTIONAL REELS

Tesoro Star Drag Reels	43
Cortez Star Drag Reels	43
Cold Water SS Low Profile Line Counter	44
Cold Water Low Profile Line Counter	44
Cold Water Line Counter Reels	45
Cold Water Wire Line Reels	45
Convactor Reels	46
Convactor Low Profile Reels	46
Convactor Line Counter Reels	47
Magda Pro Line Counter Reels	48
Classic Pro XP Reels	48
Classic CLX Reels	48
Makaira Lever Drag Reels	50
Makaira SEa Matte Black Lever Drag Reels	51
Makaira SEa & SEa Silver Lever Drag Reels	52
Alijos 2-speed Lever Drag Reels	56
Alijos Lever Drag High Speed Reels	56
Cavalla Lever Drag Reels	57
Solterra SLX "B" Lever Drag Reels	58

4 RODS

Psycho Stick Rods	62
Guide Select Cranking Rods	63
Tournament Concept Rods	63
Serrano Rods	64
Cerros Rods	64
Reflexions "b" Rods	65
Guide Select "a" Swimbait Rods	66
Avenger Carp Rods	66
EVx Musky Rods	67
Psycho Stick Musky Rods	67
Snakehead Junky Rods	68
Dead Eye Custom Rods	69
Dead Eye Pro Rods	69
Dead Eye Classic Rods	70
X-Series Salmon & Steelhead Rods	71
GLS Custom Rods	72
Guide Select Pro Rods	73
Guide Select Classic Rods	74
Kokanee Black Rods	74
SST "a" Carbon Grip Rods	75
SST "a" Special Edition Rods	76
SST "a" Cork Grip Rods	77
SST "a" Trout, Kokanee, Halibut Rods	78
Celilo Graphite Rods	79

RODS CONT.

Celilo Specialty Rods	80
Connoisseur Rods	81
White Diamond Rods	82
Blue Diamond Rods	82
Classic Pro GLT Rods	83
SCT Albacore Rods	84
PCH Custom Rods	85
PCH Custom Inshore Rods	86
PCH Trolling Rods	86
Makaira Trolling Rods	88
Cedros "a" Jigging Rods	89
Monterey Salmon, Halibut & Sturgeon Rods	89
Cavalla Boat Rods	90
ECS Custom Rods	92
DTR Custom Offshore Rods	93
DTR Custom Inshore Rods	94
Silver Slayer Tarpon Rods	95
SRT Inshore Elite Rods	96
SRT Inshore Premier Rods	96
RTF Inshore Rods	97
Sarasota Rods	98
Epixor Rods	99
Ceymar Inshore Rods	99
Axeon Pro Rods	100
Cortez Sabiki Rods	100
Battle Cat Rods	101
Crab Snare Special Rods	101
Hawaiian Custom Rods	102
Hawaiian Custom Popping Rods	103
Hawaiian Custom Jigging Rods	103
HCS Custom Surf Rods	104
Cedros Surf Rods	105
Rockaway Surf HD Rods	106
Rockaway Surf Rods	106
Rockaway Surf SP Rods	107
Solaris Surf Rods	108
Nesika Surf Rods	109
Longitude Surf Rods	109
Tundra Rods	110
Tundra Pro Rods	110
Cold Water Ice Combos	111
Cold Water Deadstick Combos	111
Trio Pro & Trio Ice Rods	112
ICX Ice Rods	113
Inspira Ice Rods	113
Cold Water Ice Rods	114
Cold Water Deadstick Rods	114

5 TRAVEL

Voyager Signature Surf Rods	117
Voyager Signature Boat Rods	117
Voyager Signature Freshwater Rods	118
SST "a" Travel Rods	119
Voyager Travel Kit	120

6 FLY & FLOAT

Helios SX Fly Reels	124
RAWII centerpin Float Reels	125
Aventa Float Reels	125
Aventa Float Rods	126
SST "a" Float Rods	126
SLV "b" Fly Reels	127
Sierra X Fly Reels	127
SLV Fly Rods	128
Crisium Fly Rods	128

7 COMBOS

Halogen Combos	131
Avenger Spinning Combos	132
Avenger Salmon/Steelhead Combos	132
Dead Eye Classic Combos	133
Convactor Combos	133
Ceililo Kokanee Combos	134
Great Lakes Trolling Combo	135
Ceymar Combos	135
Safina Pro Saltwater Combos	136
Fuel Spin Combos	137
Alaris Combo	138
Aveon Combos	138
Rox Combos	139
Fin Chaser "X" Series Combos	140
Tundra Combo	141
Tundra Pro Combos	142
Steeler XP Combos	143
Boundary Combos	144
Cascade II Combos	144

8 ACCESSORIES & APPAREL

Cal's Universal Drag Reel Grease	147
Polar-X Reel Grease	147
Accessories	148
Okuma Apparel	148

Okuma Warranty & Repair Centers	149
Candadian Warranty Centers	149
Authorized Repair Centers	150
Okuma Sales Representatives	152

SPINNING REEL TECHNOLOGY



ALG

With today's super braided lines & lighter more compact reels, ALG offers anglers lighter weight gears without compromising on strength & durability. Adding to their longevity, ALG gears are anodized to hold up to the elements much better than traditional gearing materials.

PRECISION ELLIPTICAL GEARING SYSTEM

The Precision Elliptical Gearing System advantage boils down to one thing & one thing only - performance. By regulating the speed of the spindle stroke, reels equipped with this system wind line more consistently & uniformly on the spool, resulting in level line lay. This creates less friction during casting for increased distance, greater accuracy & longer line life, as well as smoother, more uniform drag pressures. Pick up any Okuma reel equipped with this feature & feel for yourself the balance, smoothness & power that are all characteristics of the Precision Elliptical Gearing System.



SPINNING REEL DUAL FORCE DRAG

DFD incorporates both surfaces of the spool to maximize high-end drag pressure, efficiency & overall smoothness. Mounted in the top of the spool & protected by the Hydro Block system is a multi-disc felt drag system that works in conjunction with a secondary drag system that is mounted under the spool. Even pressure is applied to both surfaces of the spool for maximum stability.



MAXGEAR

Makaira reels feature a forged, machine cut stainless steel main gear paired with a 17-4 stainless steel pinion gear. This gear system is unmatched in this category.



HDGII

Okuma's proprietary High Density Gearing II incorporates an extremely strong alloy composition with a special anti-corrosion coating process. The result is high density, corrosion resistant gears that are built to handle the severe elements & brutal strains placed on a reel's internal gear system.



LITECAST™

Litecast™ is the latest in Okuma's reel technology. Reels with the Litecast™ structure are composed using a magnesium material in the casting process, making the integrity of the reel incredibly strong & 15% lighter than aluminum alloy reels. Okuma Cedros Saltwater Spinning Reels feature the new Litecast™ construction.



C-40X

Okuma's C-40X carbon technology utilizes a specially blended graphite polymer. The carbon fibers in this material are elongated & reinforced, creating a substantially stronger composite than standard graphite materials. At 25% lighter, 1.5 times stronger & 100% anti-corrosive, C-40X translates into an extremely lightweight & durable construction.



CFR CYCLONIC FLOW ROTOR

The Cyclonic Flow Rotor (CFR) was designed to create a "cyclonic" airflow, which significantly increases air flow through the ported rotor. This thoroughly tested design allows for a much faster drying time if the reel becomes wet, minimizing corrosion possibilities throughout the reel.



ALUMILITE FRAME CONSTRUCTION

AlumiLite construction incorporates Okuma's rigid aluminum body technology on spinning, trolling and fly reel designs. Aluminum frames are stronger and more rigid and are capable of withstanding more pressure and torque than traditional graphite frames. These lightweight, diecast aluminum frames provide more precise tolerances for precision gear alignment, maximum castability and ultimate durability.

TORSION CONTROL ARMOR

The Torsion Control Armor (TCA) design found on the new Inspria spinning reels is made with Okuma's C-40X long-strand carbon fiber technology. This not only makes the reel lighter, but also makes the reel extremely rigid which reduces twist & torque, keeping the internal parts in perfect alignment.



CENTRIFUGAL DISC BAIL

Okuma's Centrifugal Disc Bail (CDB) is a unique new design that incorporates a heavier brass disc that is perfectly weighted & balanced to create a smoother & easier bail operation, while increasing the strength & stability of the overall bail function.

SPINNING REEL TECHNOLOGY



BAITFEEDING SYSTEM

Okuma's baitfeeding system allows anglers to disengage their spinning reel spool & allow their bait to run freely. The baitfeeding system incorporates a secondary micro-adjustable drag system at the rear of the reel that allows for precise adjustment of the spool for bait control. In order to disengage this system simply turn the handle. The On/Off lever on the rear of the reel will automatically disengage the baitfeeding system so you can fight your fish with the main drag system.



HYDRO BLOCK

The Hydro Block design features a rubber gasket mounted in the top of a spinning reel spool. This rubber seal blocks water & foreign materials from entering the drag system. The Hydro Block system ensures that your drag washers always perform at optimal levels.



QUICK-SET

This system allows for instant handle engagement & eliminates all handle back play commonly found in many reels. This is accomplished by using a corrosion-resistant stainless steel roller bearing that engages the reel in one direction for rock-solid hook sets.



EFR II

The Even Flow Roller System utilizes a ball bearing under the line roller to maximize efficiency. This roller helps reduce line twists by freely rolling over the line roller without friction. Without this system, line will naturally twist when drag is pulled.



RES II

The RES II System stands for Rotor Equalizing System. This second-generation RES System incorporates a computer-balanced weight precisely placed in the rotor. This weight allows for precision balance & eliminates all spool wobble for perfect alignments & smooth cranking.

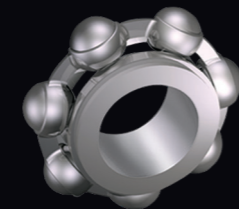

HIGH PERFORMANCE BALL BEARINGS

The balls used on the HPB's are constructed from the same high-grade stainless steel material as the bearing housing. These bearings were designed to be more than 10 times more resistant to saltwater than standard stainless steel bearings. These bearings may even outlast the angler himself.

LOW PROFILE REEL TECHNOLOGY



LITECAST™

Litecast™ is the latest in Okuma's reel technology. Reels with the Litecast™ structure are composed using a magnesium material in the casting process, making the integrity of the reel incredibly strong & 15% lighter than aluminum alloy reels. Okuma Hakai Baitfeeder Reels feature the new Litecast™ construction.



FLITE SPOOL

Flight spool is a Dream Tackle Design allowing Okuma to offer a super tuned spool on our premium baitcast reels. The spool is 33mm in diameter and was developed for long distance casting as well as finesse style fishing. The complete spool design weighs in at just 0.33 ounces as a result of its uniform thickness, which is what helps set this super tuned spool apart from others.



FLITE SHAFT

Flite shaft is a patented hollow stainless steel spool shaft with precision stainless steel balls pressed on each end. These balls rotate under pressure to reduce friction and help increase casting distance. Providing the perfect balance point between weight, strength and smoothness.

PRECISION SUS BALLS ON ENDS FOR PERFECT BALANCE

HOLLOW MAIN SHAFT



TGT (Traction Grip Technology)

Okuma TGT is made of non-slip durable materials that not only provides maximum grip, but comfort and control in all weather conditions.

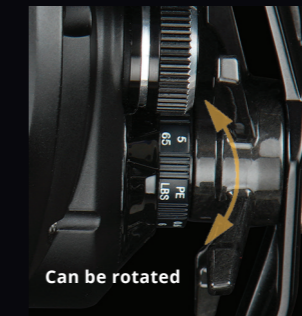

Can be rotated

UNIVERSAL LINE DIAM. INDICATOR

Always know what line you spooled on your reel when you pick it up.



MCS

Okuma's Magnetic Control System reduces backlash & improves casting distance by utilizing the magnetic field generated by the high RPM spinning of the spool during casting. The magnetic field is influenced by the adjustable cast control magnets which exert an opposing force & allows for minute & accurate adjustments.



VELOCITY CONTROL

The Velocity Control System is an adjustable, 6-pin centrifugal braking system for precision spool control. Weights can be adjusted IN or OUT for additional spool control. Positioning the weights in toward the spool allows for more freespool, while adjusting the pins out away from the spool allows for more control. Anglers can alternate weights until they find that perfect balance for casting.



SPOOL ACCESS PORT

This unique new design can be found on Okuma's low profile baitcast reels. The Spool Access Port allows for quick access to the spool by simply sliding the lock/unlock lever on the sideplate opposite the handle. This system allows for quick spool changes, but more importantly it allows quick access for adjusting the Velocity Control System.

TROLLING AND CONVENTIONAL REEL TECHNOLOGY



SELF LUBRICATING GEAR SYSTEM

The self-lubricating gear system is a feature found on Okuma's higher-end star drag reels. The main gear on this system incorporates a heat-sensitive oil-impregnated brass bushing that is mounted in the center of the gear. This system releases oil if friction increases to keep the main gear & drive shaft running smoothly in all conditions. Okuma is the first company to adopt this technology which originated in the large machine industry where this function has been time tested for many years.

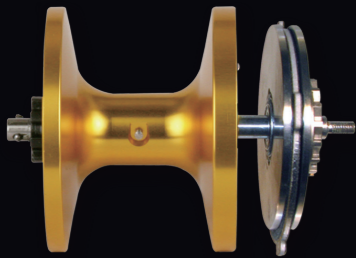

LEVER DRAG DUAL FORCE DRAG

For extremely smooth & strong drag outputs, Okuma's Makaira and Alijo's 2-speed reels are designed with a patented Dual Force Drag system. This drag system is specifically engineered to be mounted in the right side of the spool, designed around a Pull Bar Drag System which keeps all mechanical workings in precise alignment & places no pressure on the frame. This system works in conjunction with a custom designed thrust bearing, which alleviates side load at heavy drag settings.



2-SPEED GEARING

Okuma's 2-speed technology incorporates two sets of stainless steel main & pinion gears, allowing anglers the option of a high-speed gear ratio or a powerful low-speed gear ratio for maximum power & torque. To shift gears it is as easy as pushing a button or popping a lever with Okuma's unique shifting design to obtain the appropriate gear ratio you desire.

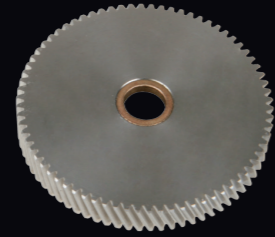

XL GEARING

The XL gearing design found on both lever drag & star drag reels incorporates an oversized gear box that features an enlarged gearing system & enlarged drag system. The drag surface areas on this system are more than 50% larger than a standard gear-box design. For the gear system, the major advantage is that the gear teeth are substantially larger, allowing more strength & cranking power. This is how we are able to offer a high-speed gear ratio reel without sacrificing cranking power. Our XL gearing system essentially turns your reel into a winch.



MACHINED RIGID FRAME

Okuma's Machined Rigid Frame construction incorporates a one-piece fully-machined aluminum frame. These rigid bar-stock aluminum frames are the ultimate in precision alignment & tolerances withstanding more pressure & torque than any other material used in our industry for frame materials. Okuma features these anodized frames on fly reels, baitcast reels, lever drag reels & star drag trolling reels.

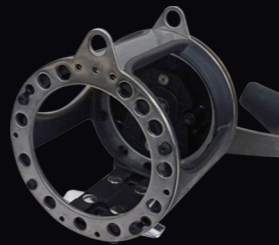

BODY ARMOR

Okuma's stainless steel Body Armor eliminates the frame flex commonly found in graphite framed trolling reels. This feature incorporates two large stainless steel rings that are mounted to both sides of the frame. The harness lugs are integrated into the body armor design & eliminate the pressure commonly placed on the harness lugs by redistributing the pressure to these large-diameter rings.

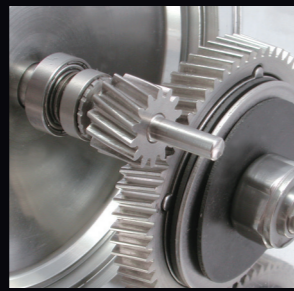

SPEED LOC PINION GEAR SYSTEM

The SLG technology incorporates a dual-step pinion gear system on star drag reels that allows positive engaging at extreme high speeds. The SLG system allows for instant gear engagement when engaging from freespool to strike at speeds in excess of 50 MPH.

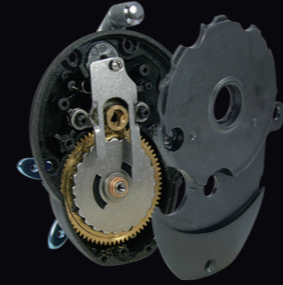

MSS

Strong, Stable, Smooth - Okuma's Mechanical Stabilizing System is a support system that ties the spool shaft, pinion gear, pinion gear bearing, drive shaft & main gear together with a single support system. While other reels on the market offer minimal or no gear stabilization, this patented Okuma design allows all of these critical parts to stay in precise alignment. Designed specifically to hold up to the demands of braided & wire line fishing, the MSS support system stabilizes the spool shaft at 3 key stress points to eliminate flex under pressure - which directly translates into a reel that is more durable, stronger & smoother than the competition.



WIDE MOUTH LEVELWIND

This heavy-duty, stainless steel levelwind is Titanium coated & built to withstand the punishment of both braided & wire lines. The guide has been designed with an increased opening to insure proper knot clearance when fishing with double lines. This wide space allows for Albright or similar connection knots, as well as swivels & copper line to pass through the guide easier & be wound directly on the spool.



T-BAR HANDLE

T-Bar Handle: The patented design of the T-Bar handle offers a true ergonomically correct angle to ensure an angler gets maximum power with minimum fatigue. The T-bar takes full advantage of the natural dynamics of the human hand, wrist & forearm to help sustain power & endurance for the angler.



HIPPO GRIP

The Hippo Grip is a unique reel-clamp design that serves triple duty when fishing offshore. This heavy-duty, forged aluminum reel clamp securely supports your reel to the rod for maximum safety. This clamp also incorporates a small hole that was designed to be used with a safety line for trolling. On the rear of the clamp is a large diameter hole that was designed to be used as a trigger. The large hole should be mounted facing the butt of the rod.



MCS

Okuma's Magnetic Control System is a fully-sealed, 100% waterproof cast control system that reduces backlash & improves casting distance by utilizing the magnetic field generated by the high RPM spinning of the spool during casting. The magnetic field is influenced by the adjustable cast control magnet which exerts an opposing force & allows for minute & accurate adjustments.



STRIKE ZONE

Okuma's Strike Zone linecounter system incorporates a mechanical counter that precisely measures line based on spool revolutions. These counters measure in feet & are calibrated at the factory to be most accurate with a full spool & monofilament lines.



ERGO GRIP

The Ergo Grip handle knob is an extremely comfortable oversized handle-knob design for both speed & power. This soft-touch knob has been ergonomically designed to fit in the palm of your hand & will be found on certain Okuma lever drag reels, star drag reels & some spinning reel models.



CRC

Okuma's Corrosion Resistance Coating (CRC) consists of a thin layer of Corrosion X HD applied to all internal & external parts. The CRC process actually penetrates & bonds to the metal, which helps significantly in the reduction of corrosion, & towards the long term protection of your reel.

ROD TECHNOLOGY

Ultimate Flex Reinforcement



A TIP TO CATCH THEM ALL

Anglers will immediately identify the benefits of Okuma's Ultimate Flex Reinforcement (UFR) technology through light-weight and sensitive rod-tip construction. UFR technology incorporates three times the strength and lifting power over traditional rods, making it powerful enough to fight the toughest of fish, but sensitive enough to feel the lightest of bites.

Ultimate Matrix Reinforcement



LIGHTWEIGHT STRENGTH BUILT FOR ANY CHALLENGE

Okuma's Ultimate Matrix Reinforcement (UMR) technology maximizes rod strength while minimizing weight, so you can rise to meet any challenge.



SPINNING REELS

Spinning reels are an opportunity. Worldwide, they're most often the very first reel a beginning angler picks up. For many, they're the only reel type that's ever needed. As such, spinning reels define the experience from pond panfish to offshore big game. At every level the Okuma selection is angler-centric, delivering a fantastic fishing experience through better design, materials & construction techniques. Our reels need to inspire participation today, tomorrow & in the future ahead, a responsibility we gladly accept.

MAKAIRA

SPINNING REEL

Derived from the Okuma 4D Concept which focuses on Design, Drive, Drag & Durability as core performance elements, Makaira spinning reels are built from the ground up to be the toughest, most durable spinning reels an angler can own. Constructed from the finest & strongest materials available, Makaira series reels are big game reels developed to pursue everything from Giant Trevally, trophy-sized Yellowtail & Amberjack, to the most formidable adversaries in the ocean, like giant Bluefin Tuna, Marlin, cow Yellowfin Tuna & large sharks.



MAXGEAR

Makaira reels feature a forged, machine cut stainless steel main gear paired with a 17-4 stainless steel pinion gear. This gear system is unmatched in this category.



The Makaira is unmatched in elite level spinning reels with a forged, machine cut aluminum body, sideplate & rotor. There are no die-cast parts on this reel. The Mak is the elite reel in the category, with a complete forged aluminum housing.

The Makaira drag system utilizes the complete surface area of the carbon fiber drag washers; the system has been engineered to make full contact with the outer edges of our carbon washers, which maximizes efficiency & the ability to deliver high drag outputs. The DFD concept applies pressure to both sides of the spool in order to maximize use of the available surface area, enlarging the working surfaces of our drag system which dramatically improves heat dissipation.



BEARINGS

CARBON FIBER

Makaira spinning reels are engineered to withstand the most brutal conditions the ocean can offer. To accomplish this, we equipped this series with 23 different oil-retaining o-rings & gaskets. Our engineers made this reel impervious to the elements & by making it water tight, all the internal mechanisms are sealed & protected from salt. The result is the best-of-the-best when it comes to big game fishing reels.



MAKAIRA[®]

SPINNING REEL



MAKAIRA SPINNING REELS

- Forged aluminum, machine cut body/sideplate
- Forged aluminum, machine cut Cyclonc Flow rotor
- Forged stainless steel main gear for ultimate power & strength
- Precision machine cut 17-4 grade stainless steel pinion gear
- Oversized 17-4 grade stainless steel spool shaft reduces flex
- Hydro Sealed Body & DFD system for maximum protection
- Carbonite high output drag with Cal's drag grease on full DFD
- Customized pre-set drag system, works like a lever drag reel
- 9HPB + 1RB corrosion resistant stainless steel bearings
- Dual anti-reverse system for maximum strength & reliability
- Quick-Set stainless steel German anti-reverse roller bearing
- CRC: Corrosion-resistant coating process
- Machined aluminum, 2-tone anodized spool with LCS lip
- Machined aluminum screw-in handle arm for added strength
- Right & Left handles are designed differently: Order by Rt/Lt
- Heavy duty, solid aluminum bail wire with manual trip function
- Rotor brake system works in conjunction with manual bail trip
- Machined aluminum handle knob on 20,000 & 30,000 size.
- Ergo Grip, Rubber Soft Touch handle on 10,000 size
- Makaira reels are backed by a 5-year limited warranty

MAKAIRA SPINNING REEL HANDLES

Handle Model #	Description	Original Factory Handle	Reel Compatibility	Handle Length
ARMKSH-10LT	Left Handle Crank with Ergo Grip Handle Knob	MK-10000L	10000/20000/30000 LS/RS	76mm
ARMKSH-10RT	Right Handle Crank with Ergo Grip Handle Knob	MK-10000R	10000/20000/30000 LS/RS	76mm
ARMKSH-LT	Left Handle Crank with Aluminum Handle Knob	MK-20000/30000LS	10000/20000/30000 LS/RS	83mm
ARMKSH-RT	Right Handle Crank with Aluminum Handle Knob	MK-20000/30000RS	10000/20000/30000 LS/RS	83mm

Model	Gear Ratio	Bearings	Weight (oz.)	LINE Retrieve	Max Drag	Mono Line Capacity	Braided line rating
MAKAIRA SPINNING REELS							
MK-10000L*	4.9:1	9HPB + 1RB	28.2	40"	55-lbs	470/12, 340/15, 280/20	415/50, 290/65
MK-20000LS*	5.8:1	9HPB + 1RB	35	51.6"	66-lbs	580/20, 430/25, 330/30	490/65, 400/80
MK-30000LS*	5.8:1	9HPB + 1RB	39	65.7"	66-lbs	490/40, 360/50, 300/60	700/80, 570/100
MK-10000R	4.9:1	9HPB + 1RB	28.2	40"	55-lbs	470/12, 340/15, 280/20	415/50, 290/65
MK-20000RS	5.8:1	9HPB + 1RB	35	51.6"	66-lbs	580/20, 430/25, 330/30	490/65, 400/80
MK-30000RS	5.8:1	9HPB + 1RB	39	65.7"	66-lbs	490/40, 360/50, 300/60	700/80, 570/100

*Left Handed Retrieve



TESORO

TESORO SPINNING REELS

- Alumilite body, sideplate and Cyclonic Flow rotor
- IPX-7 full body waterproof design for ultimate protection
- 12HPB + 1RB corrosion resistant stainless-steel bearings
- Carbonite high output DFD drag with Cal's drag grease
- Specialized titanium spool shaft reduced flex and weight
- Dual anti-reverse for maximum strength and reliability
- Oversized brass main gear and C-6191 brass pinion gear
- Even Flow Line Roller system with DLC coating
- Rigid machined aluminum screw in handle design
- Carbon fiber handle knob for comfort and weight reduction
- Pinion gear: double supported with ball bearings
- Frictionless main shaft design provides smooth operation
- Machined aluminum screw in handle for maximum strength
- Rotor brake system works in conjunction with manual bail trip
- CRC: Corrosion Resistant Corrosion Coating process
- Tesoro reels are backed by a 1-year limited warranty



TSR-8000HA

TSR-18000PA

	MODEL	GEAR RATIO	BEARINGS	WEIGHT (OZ.)	LINE RETRIEVE	MAX DRAG	MONO LINE CAPACITY	BRAIDED LINE RATING
TESORO SPINNING REELS - HIGH SPEED MODELS								
NEW	TSR-8000HA	5.8:1	12 HPB + 1RB	24.6	44.1"	55-lbs	440/12, 300/16, 245/20	500/40, 425/50
NEW	TSR-10000HA	5.8:1	12 HPB + 1RB	25.2	47.6"	55-lbs	550/12, 375/16, 305/20	500/50, 330/65
NEW	TSR-14000HA	5.8:1	12 HPB + 1RB	25.5	49.6"	55-lbs	710/12, 480/16, 395/20	450/65, 390/85
TESORO SPINNING REELS - STANDARD SPEED MODELS								
NEW	TSR-18000PA	4.4:1	12 HPB + 1RB	32.7	41.7"	55-lbs	560/20, 445/25, 320/30	460/65, 400/80
NEW	TSR-20000PA	4.4:1	12 HPB + 1RB	32.7	43.7"	55-lbs	670/20, 530/25, 390/30	—

DUAL FORCE DRAG SYSTEM:

Mounted in the top of the spool and protected by the Hydro Block system is a Carbonite drag stack that works in conjunction with a secondary oversized Carbonite drag system that is mounted under the spool. Even pressure is applied to both surfaces of the spool for maximum stability and significantly increased drag output compared to traditional single drag systems.



SALINA

SALINA SALT REELS

- Carbonite DFD drag system with Cal's drag grease
- LITECAST body is 15% lighter than diecast aluminum
- 6HPB + 1RB corrosion resistant stainless-steel bearings
- Full grease pack and waterproof seals on key bearings
- Even Flow Line Roller system with DLC coating
- Dual anti-reverse on 8000-14000 sizes
- HDGI: High density main gear for durability
- Precision machine cut brass pinion gear
- Machined aluminum, screw-in handle arm
- Machined aluminum, 2-tone anodized ball handle knob
- Manual bail trip function on 8000-14000 sizes
- CRC: Corrosion Resistant Corrosion Coating process
- Salina spinning reels are backed by a 1-year limited warranty



SA-8000A

	MODEL	GEAR RATIO	BEARINGS	WEIGHT (OZ.)	LINE RETRIEVE	MAX DRAG	MONO LINE CAPACITY	BRAIDED LINE RATING
SALINA SALT SPINNING REELS - HIGH SPEED MODELS								
NEW	SA-4000HA	5.8:1	6 HPB + 1RB	14.6	35.4	33-lbs	280/8, 230/10, 190/12	230/30, 190/40
NEW	SA-5000HA	5.8:1	6 HPB + 1RB	14.9	37.4	33-lbs	295/10, 245/12, 210/14	240/40, 210/50
NEW	SA-6000HA	5.8:1	6 HPB + 1RB	15.2	39.8	33-lbs	320/12, 215/16, 175/20	320/40, 270/50
SALINA SALT SPINNING REELS - STANDARD SPEED MODELS								
NEW	SA-8000A	5.4:1	6 HPB + 1RB	22.9	40.6	44-lbs	440/12, 300/16, 245/20	500/40, 425/50
NEW	SA-10000A	5.4:1	6 HPB + 1RB	23.5	44.1	44-lbs	550/12, 375/16, 305/20	500/50, 330/65
NEW	SA-14000A	5.4:1	6 HPB + 1RB	22.9	45.7	44-lbs	690/12, 470/16, 380/20	410/65, 370/85



CEDROS

CEDROS REELS

- DFD: Precision Dual Force Drag system
- Multi-disc drag adjustment for more precise settings
- LITECAST: Body construction is 15% lighter
- CRC: Corrosion resistant coating process
- 6HPB + 1RB corrosion resistant stainless steel bearings
- Dual anti-reverse feature on 8000-14000 sizes
- Quick-Set anti-reverse roller bearing
- Manual bail trip function 8000-14000 sizes
- HDGII: Corrosion resistant, High density gearing
- Precision machine cut brass pinion gear
- Machined aluminum, 2-tone anodized spool
- Machined aluminum, screw-in handle arm
- Cedros spinning reels are backed by a 1-year limited warranty



CJ-10000



CJ-8000

Specifically designed for saltwater use, the Cedros spinning reels feature Okuma's Litecast Blade body design, Dual Force Drag System for extreme stopping power & our proprietary High Density Gearing with a special corrosion resistant coating. Combine this with a high-speed gear ratio & a customized aluminum handle, you have one of the best saltwater jig fishing reels on the market.

MODEL	GEAR RATIO	BEARINGS	WEIGHT (OZ.)	LINE RETRIEVE	MAX DRAG	MONO LINE CAPACITY	BRAIDED LINE RATING
CEDROS SPINNING REELS - HIGH SPEED							
CJ-4000H	5.8:1	6BB + 1RB	13.4	35.4"	33-lbs	280/8, 230/10, 190/12	230/30, 190/40
CJ-6000H	5.8:1	6BB + 1RB	14.3	39.8"	33-lbs	320/12, 215/16, 175/20	320/40, 270/50
CEDROS SPINNING REELS - STANDARD SPEED							
CJ-8000	5.4:1	6BB + 1RB	22.0	40.9"	44-lbs	440/12, 300/16, 245/20	500/40, 425/50
CJ-10000	5.4:1	6BB + 1RB	22.7	44.1"	44-lbs	550/12, 375/16, 305/20	500/50, 330/65
CJ-14000	5.4:1	6BB + 1RB	22.9	45.8"	44-lbs	690/12, 470/16, 380/20	410/65, 370/85



AZORES

AZORES SALTWATER REELS

- DFD: Precision Dual Force Drag system
- Precision click drag adjustment for more precise settings
- Multi-disc, Carbonite & felt drag washers for DFD
- 6HPB + 1RB corrosion resistant stainless steel bearings
- Quick-Set anti-reverse roller bearing plus ratchet system
- Dual anti-reverse system for maximum security
- Precision machine cut brass pinion gear
- CRC: Corrosion-resistant coating process
- HDGII: Corrosion-resistant, High density gearing
- ALC: Rigid diecast aluminum body, sideplate & rotor
- MSS: carbon Mechanical Stabilizing System
- Machined aluminum, 2-tone anodized spool with LCS lip
- Machined aluminum handle arm for added strength
- Hydro Block water tight drag seal
- Heavy duty, solid aluminum bail wire
- Azores spinning reels are backed by a 1-year limited warranty



Z-6000H-BLUE



Z-8000H-BLUE

MODEL	GEAR RATIO	BEARINGS	WEIGHT (OZ.)	LINE RETRIEVE	MAX DRAG	MONO LINE CAPACITY	BRAIDED LINE RATING
AZORES SALTWATER REELS							
Z-4000H-BLUE	5.8:1	6BB + 1RB	12.0	35.8"	28-lbs	300/8, 250/10, 210/12	215/30, 150/40
Z-6000H-BLUE	5.8:1	6BB + 1RB	18.5	41.2"	29-lbs	310/12, 215/16, 180/20	270/50, 180/65
Z-8000H-BLUE	5.4:1	6BB + 1RB	25.6	43.4"	44-lbs	460/12, 320/16, 270/20	370/50, 245/65
Z-14000H-BLUE	5.4:1	6BB + 1RB	26.3	47.4"	44-lbs	680/12, 470/16, 400/20	300/65, 240/80

ITX

ITX CARBON REELS

- Lightweight & rigid C-40X rotor & TCA construction
- Multi-disc, carbon fiber drag system with Hydro Block gasket
- 7HPB + 1RB High Performance, grease packed bearings
- Quick-Set anti-reverse roller bearing
- CFR: Cyclonic Flow Rotor Technology
- Machined aluminum screw in handle design
- TGT Grip: Traction Grip Technology
- Precision machine cut brass pinion gear
- Machined aluminum, 2-tone anodized aluminum spool
- Heavy duty, solid aluminum bail wire
- RESII: Computer balanced Rotor Equalization System
- ITX spinning reels are backed by a 1-year limited warranty

MACHINED ALUMINUM SCREW IN HANDLE DESIGN WITH TGT GRIP

The machined aluminum handle screws directly into the reel for the ultimate in a direct & secure connection.

(TGT: Traction Grip Technology)



MODEL	GEAR RATIO	BEARINGS	WEIGHT (OZ.)	LINE RETRIEVE	MAX DRAG	MONO LINE CAPACITY	BRAIDED LINE RATING
ITX CARBON REELS							
ITX-1000H	5.8:1	7HPB + 1RB	7.1	28.7"	7-lbs	280/2,140/4,110/6	150/15
ITX-2500H	6.0:1	7HPB + 1RB	8.3	33.5"	18-lbs	195/6,165/8,130/10	130/30
ITX-3000H	6.0:1	7HPB + 1RB	8.3	33.5"	18-lbs	240/6,200/8,160/10	160/30
ITX-4000H	6.0:1	7HPB + 1RB	10.1	37.0"	22-lbs	260/8,220/10,180/12	215/30



SURF-8K

SURF-8K REELS

- Carbonite drag washers on Dual Force Drag
- Heavy duty, brass DFD & spool shaft stabilizer
- 5HPB+1RB corrosion resistant stainless steel bearings
- CRC: Corrosion-Resistant Coating process
- Machined aluminum, screw in handle system
- Slow oscillation system for improved line lay
- Corrosion resistant frame, sideplate and rotor
- CFR: Cyclonic Flow Rotor technology
- Hydro Block water tight drag seal
- Machined aluminum, 2-tone anodized spool with LCS lip
- Heavy duty solid aluminum bail wire
- RESII: Computer balanced Rotor Equalizing System
- SURF-8K reels are backed by a 1-year limited warranty

MODEL	GEAR RATIO	BEARINGS	WEIGHT (OZ.)	LINE RETRIEVE	MAX DRAG	MONO LINE CAPACITY	BRAIDED LINE RATING
SURF-8K REELS							
SURF-8K	4.7:1	5HPB + 1RB	26.9	42.6"	40-lbs	770/12,540/16,450/20	840/40,710/50



ROCKAWAY SURF

ROCKAWAY SURF & BAITFEEDER REELS

- 4BB + 1RB stainless steel bearing system
- Quick-Set anti-reverse roller bearing
- 5.3:1 gear ratio with 40.9" of line pickup
- Precision machine cut brass pinion gear
- CFR: Cyclonic Flow Rotor technology
- Corrosion resistant frame, sideplate & rotor
- Rigid metal handle design to reduce flex
- Long cast, 2-tone anodized aluminum spool
- On/Off auto trip baitfeeding system on RBF models
- 5BB + 1RB stainless steel bearing system on RBF model
- ROCKAWAY reels are backed by a 1-year limited warranty

MODEL	GEAR RATIO	BEARINGS	WEIGHT (OZ.)	LINE RETRIEVE	MAX DRAG	MONO LINE CAPACITY	BRAIDED LINE RATING
ROCKAWAY SURF REELS							
RA-6000	5.3:1	4BB + 1RB	17.0	40.9"	26-lbs	375/12,260/16,220/20	400/40
RA-8000	5.3:1	4BB + 1RB	18.7 oz	48.4"	35-lbs	550/12,370/16,305/20	570/40
ROCKAWAY BAITFEEDER REELS							
RBF-8000	5.3:1	5BB + 1RB	20.7 oz	48.4"	35-lbs	550/12,370/16,305/20	570/40





CDX-60

Coronado CDX

CORONADO CDX BAITFEEDER REELS

- On/Off auto trip bait feeding system
- DFD: Precision Dual Force Drag system
- Carbonite drag washers on Dual Force Drag
- Heavy duty, brass DFD & spool shaft stabilizer
- 4HPB+1RB corrosion resistant stainless steel bearings
- Quick-Set anti-reverse bearing allows for zero back play in handle
- CRC: Corrosion-Resistant Coating process
- Machined aluminum, screw in handle system
- Slow oscillation system for improved line lay
- Corrosion resistant frame, sideplate and rotor
- CFR: Cyclonic Flow Rotor technology
- Hydro Block water tight drag seal
- Machined aluminum, 2-tone anodized spool with LCS lip
- Heavy duty solid aluminum bail wire
- RESII: Computer balanced Rotor Equalizing System
- Coronado reels are backed by a 1-year limited warranty

MODEL	GEAR RATIO	BEARINGS	WEIGHT (OZ.)	LINE RETRIEVE	MAX DRAG	MONO LINE CAPACITY	BRAIDED LINE RATING
CORONADO CDX BAITFEEDER REELS							
CDX-55	4.4:1	4HPB+1RB	19.4	32.5"	28-lbs	385/10, 325/12, 285/14	245/50
CDX-60	4.4:1	4HPB+1RB	19.8	34.1"	26.9-lbs	385/12, 270/16, 225/20	290/50
CDX-65	4.9:1	4HPB+1RB	29.0	41.7"	33.7-lbs	540/12, 380/16, 320/20	315/65
CDX-80	4.9:1	4HPB+1RB	30.1	45.4"	37.5-lbs	690/12, 485/16, 405/20	235/80



HSX-30

Helios SX

HELIOS SX REELS

- Lightweight C-40X carbon frame & sideplates
- C-40X Cyclonic Flow Rotor for corrosion resistance
- TCA: Torsion Control Armor reduces twisting
- 8HPB + 1RB corrosion resistant stainless steel bearings
- Quick-Set anti-reverse roller bearing
- Precision machine cut brass pinion gear
- ALG: Precision AlumiLite alloy main gear & oscillating gears
- Rigid, machined aluminum, anodized handle
- Lightweight, EVA handle knobs for comfort
- Precision Elliptical Gearing system
- Machined aluminum, 2-tone anodized spool
- Heavy duty, solid aluminum bail wire
- RESII: Computer balanced Rotor Equalizing System
- Backed by a 1-year limited warranty

MODEL	GEAR RATIO	BEARINGS	WEIGHT (OZ.)	LINE RETRIEVE	MAX DRAG	MONO LINE CAPACITY	BRAIDED LINE RATING
HELIOS SX SPINNING REELS							
HSX-20	5.0:1	8HPB + 1RB	6.2	24.7"	6-lbs	220/2, 140/4, 110/6	130/10, 110/15
HSX-30	5.0:1	8HPB + 1RB	7.0	27.8"	13-lbs	240/6, 200/8, 160/10	180/15, 130/20
HSX-40	5.0:1	8HPB + 1RB	9.1	30.9"	13-lbs	260/8, 220/10, 180/12	215/30, 150/40



CHD-4000A

Ceymar HD

CEYMAR HD REELS

- HDG-II: Oversized high-density gearing
- 7BB + 1RB corrosion resistant stainless-steel bearings
- Multi-disc, oiled felt drag system
- Quick-Set anti-reverse roller bearing
- Precision machine cut brass pinion gear
- Even Flow Line Roller system with DLC coating
- Corrosion resistant frame, sideplate and rotor
- Rigid machined aluminum screw in handle design
- Pinion gear: double supported with ball bearings
- Frictionless main shaft design provides smooth operation
- Machined aluminum, 2-tone anodized spool
- Heavy duty, solid aluminum bail wire
- Rotor brake system prevents rotation while casting
- Ceymar HD reels are backed by a 1-year limited warranty

MODEL	GEAR RATIO	BEARINGS	WEIGHT (OZ.)	LINE RETRIEVE	MAX DRAG	MONO LINE CAPACITY	BRAIDED LINE RATING
CEYMAR HD SPINNING REELS - STANDARD SPEED MODELS							
CHD-1000A	5.2:1	7BB+1RB	6.9	26.8"	11-lbs	285/2, 150/4, 110/6	150/15
CHD-2500A	5.3:1	7BB+1RB	8.3	30.7"	13-lbs	195/6, 165/8, 130/10	130/30
CHD-3000A	5.3:1	7BB+1RB	8.3	30.7"	13-lbs	240/6, 200/8, 165/10	160/30
CHD-4000A	5.2:1	7BB+1RB	9.6	32.7"	20-lbs	280/8, 230/10, 190/12	220/30
CHD-C5000A	5.2:1	7BB+1RB	9.7	34.6"	20-lbs	295/10, 245/12, 210/14	230/50
CEYMAR HD SPINNING REELS - HIGH SPEED MODELS							
CHD-2500HA	6.0:1	7BB+1RB	8.3	34.6"	13-lbs	195/6, 165/8, 130/10	130/30
CHD-3000HA	6.0:1	7BB+1RB	8.3	34.6"	13-lbs	240/6, 200/8, 165/10	160/30
CHD-4000XA	6.2:1	7BB+1RB	9.6	39.0"	20-lbs	280/8, 230/10, 190/12	220/30

Epixor XT

EPIXOR XT REELS

- TCA: Torsion Control Armor reduces twisting
- Multi-disc, Japanese oiled felt drag washers
- 7BB+1RB stainless steel bearings
- Quick-Set anti-reverse bearing
- Precision machine cut brass pinion gear
- Slow oscillation system for improved line lay
- Corrosion resistant frame, sideplate and rotor
- CFR: Cyclonic Flow Rotor technology
- Rigid metal handle design for strength
- Machined aluminum, 2-tone anodized spool with LCS lip
- Heavy duty solid aluminum bail wire
- RESII: Computer balanced Rotor Equalizing System
- Epixor XT reels are backed by a 1-year limited warranty

MODEL	GEAR RATIO	BEARINGS	WEIGHT (OZ.)	LINE RETRIEVE	MAX DRAG	MONO LINE CAPACITY	BRAIDED LINE RATING
EPIXOR XT SPINNING REELS - STANDARD SPEED MODELS							
EPXT-20	5.0:1	7BB+1RB	7.3	23.9"	11-lbs	280/2, 140/4, 110/6	150/15
EPXT-30	5.0:1	7BB+1RB	8.8	27.0"	17.6-lbs	240/6, 200/8, 160/10	215/15
EPXT-40	5.0:1	7BB+1RB	10.7	30.1"	22.1-lbs	260/8, 220/10, 180/12	200/30
EPXT-55	5.0:1	7BB+1RB	11.1	34.3"	26-lbs	310/12, 215/16, 180/20	280/50
EPIXOR XT SPINNING REELS - HIGH SPEED MODELS							
EPXT-30S	6.0:1	7BB+1RB	8.8	33.4"	17.6-lbs	240/6, 200/8, 160/10	215/15
EPXT-40S	6.0:1	7BB+1RB	10.7	37.1"	22.1-lbs	260/8, 220/10, 180/12	200/30



EPXT-30



Ceymar

CEYMAR REELS

- Multi-disc, oiled felt drag system
- 7 BB + 1RB for ultimate smoothness
- C-10 /20 sizing features 6BB+1RB
- Quick-Set anti-reverse roller bearing
- Precision machine cut brass pinion gear
- Corrosion resistant frame, sideplate and rotor
- Rigid, forged aluminum, black anodized handle design
- Lightweight, EVA handle knobs for comfort
- C-65 - models feature ergo grip handle style
- Precision Elliptical Gearing system
- Machined aluminum, 2-tone anodized spool
- Heavy duty, solid aluminum bail wire
- RESII: Computer balanced Rotor Equalizing System
- Narrow Blade Body Design for reduced fatigue
- Ceymar spinning reels are backed by a 1-year limited warranty

CEYMAR BAITFEEDER REELS

- On/Off auto trip bait feeding system
- Multi-disc, Japanese oiled felt drag washers
- 7BB+1RB stainless steel bearings
- Quick-Set ant-reverse bearing
- Precision machine cut brass pinion gear
- Corrosion resistant frame, sideplate and rotor
- CFR: Cyclonic Flow Rotor technology
- Precision Elliptical Gearing System
- Rigid metal handle design for strength
- Machined aluminum, 2-tone anodized spool with LCS lip
- Heavy duty solid aluminum bail wire
- RESII: Computer balanced Rotor Equalizing System
- Ceymar reels are backed by a 1-year limited warranty



MODEL	GEAR RATIO	BEARINGS	WEIGHT (OZ.)	LINE RETRIEVE	MAX DRAG	MONO LINE CAPACITY	BRAIDED LINE RATING
CEYMAR SPINNING REELS							
C-10	5.0:1	6BB+1RB	6.0	22.6"	5-lbs	210/2, 110/4, 70/6	90/10, 80/15
C-20	5.0:1	6BB+1RB	6.8	24.0"	6-lbs	280/2, 140/4, 110/6	180/10, 140/15
C-30	5.0:1	7BB+1RB	8.2	26.6"	13-lbs	300/4, 185/6, 145/8	180/15, 155/20
C-40	5.0:1	7BB+1RB	10.0	30.9"	13-lbs	265/8, 185/10, 160/12	215/30, 150/40
C-55	4.5:1	7BB+1RB	14.2	32"	18-lbs	315/12, 265/14, 200/18	375/30, 255/50
C-65†	4.8:1	7BB+1RB	20.7	37.6"	22-lbs	300/15, 260/20, 190/25	305/50, 205/65
CEYMAR BAITFEEDER REELS							
CBF-500	5.0:1	7BB+1RB	6.7	21.9"	6-lbs	165/2, 85/4, 65/6	85/15, 65/20
CBF-1000	5.0:1	7BB+1RB	7.1	24.0"	6-lbs	280/2, 140/4, 100/6	180/10, 140/15
CBF-3000	5.0:1	7BB+1RB	9.5	28.0"	18-lbs	240/6, 200/8, 165/10	160/30, 140/40
CBF-40	5.0:1	7BB+1RB	11.2	30.9"	13-lbs	295/8, 250/10, 210/12	240/30, 200/40
CBF-55†	4.5:1	7BB+1RB	15.8	32"	19-lbs	310/12, 275/14, 220/16	310/40, 260/50
CBF-65†	4.8:1	7BB+1RB	24.6	37.6"	33-lbs	280/16, 235/20, 190/2	370/50, 240/65

† Ergo Grip Handle

Ceymar ODT

CEYMAR ODT REELS

- Multi-disc, carbon fiber drag washers
- 7BB + 1RB for ultimate smoothness
- Quick-Set anti-reverse roller bearing
- Precision machine cut brass pinion gear
- Corrosion resistant body, sideplate and rotor
- CFR: Cyclonic Flow Rotor technology
- On/Off auto trip baitfeeding system on TGF models
- Rigid, metal handle design for maximum stability
- Lightweight, EVA handle knobs for comfort
- Precision Elliptical Gearing system
- Machined aluminum, anodized spool
- Heavy duty, solid aluminum bail wire
- RESII: Computer balanced Rotor Equalizing System
- Ceymar ODT reels are backed by a 1-year limited warranty

MODEL	GEAR RATIO	BEARINGS	WEIGHT (OZ.)	LINE RETRIEVE	MAX DRAG	MONO LINE CAPACITY	BRAIDED LINE RATING
CEYMAR ODT SPINNING REELS							
NEW ODT-500A	5.0:1	7BB + 1RB	6.0	22.6"	5-lbs	210/2, 110/4, 70/6	90/10, 80/15
NEW ODT-1000A	5.0:1	7BB + 1RB	6.8	24.0"	6-lbs	280/2, 140/4, 110/6	180/10, 140/15
NEW ODT-3000A	5.0:1	7BB + 1RB	8.2	26.6"	13-lbs	200/6, 160/8, 110/10	180/15, 155/20
NEW ODT-4000A	5.0:1	7BB + 1RB	10.0	30.9"	13-lbs	270/8, 190/10, 170/12	215/30, 150/40
CEYMAR ODT BAITFEEDER REELS							
NEW ODTF-500A	5.0:1	7BB + 1RB	6.7	21.9"	6-lbs	165/2, 85/4, 65/6	90/10, 80/15
NEW ODTF-1000A	5.0:1	7BB + 1RB	7.1	24.0"	6-lbs	280/2, 140/4, 100/6	180/10, 140/15
NEW ODTF-4000A	5.0:1	7BB + 1RB	11.6	31.1"	26-lbs	270/8, 190/10, 170/12	215/30, 150/40
NEW ODTF-5000A	4.5:1	7BB + 1RB	17.0	31.5"	26-lbs	295/10, 245/12, 210/14	240/40, 210/50





AV-3000



AV-8000



AV-3000LE

AVENGER

AVENGER REELS

- Multi-disc, Japanese oiled felt drag system
- 6BB + 1RB for ultimate smoothness & performance
- Quick-Set anti-reverse roller bearing
- Precision machine cut brass pinion gear
- Corrosion resistant frame, sideplate and rotor
- CFR: Cyclonic Flow Rotor technology
- Precision Elliptical Gearing system
- Avenger spinning reels are backed by a 1-year limited warranty

MODEL	GEAR RATIO	BEARINGS	WEIGHT (OZ.)	LINE RETRIEVE	MAX DRAG	MONO LINE CAPACITY	BRAIDED LINE RATING
AVENGER SPINNING REELS							
AV-500a	5.0:1	6BB + 1RB	6.2	21.8"	6-lbs	165/2, 85/4, 65/6	120/10, 70/20
AV-1000a	5.0:1	6BB + 1RB	6.7	24.0"	6-lbs	280/2, 140/4, 100/6	200/10, 120/20
AV-2500	5.0:1	6BB + 1RB	7.8	25.8"	15-lbs	180/6, 150/8, 125/10	120/30, 100/40
AV-3000	5.0:1	6BB + 1RB	7.8	25.8"	15-lbs	210/6, 170/8, 140/10	140/30, 120/40
AV-4000	5.0:1	6BB + 1RB	10.0	30.1"	17-lbs	265/8, 220/10, 185/12	215/30, 180/40
AV-6000	4.5:1	6BB + 1RB	14.1	31.1"	33-lbs	280/12, 195/16, 165/20	300/40, 260/50
AV-8000	4.8:1	6BB + 1RB	20.0	38.3"	35-lbs	380/12, 265/16, 225/20	410/40, 350/50
AV-10000	4.8:1	6BB + 1RB	20.0	38.3"	35-lbs	465/12, 325/16, 270/20	430/50, 280/65
AVENGER SPINNING REELS - SPECIAL EDITION							
AV-3000-LE	5.0:1	6BB + 1RB	7.8	25.8"	15-lbs	210/6, 170/8, 140/10	140/30, 120/40
AV-4000-LE	5.0:1	6BB + 1RB	10.0	30.1"	17-lbs	265/8, 220/10, 185/12	215/30, 180/40

CFR CYCLONIC FLOW ROTOR

AVENGER ABF

AVENGER BAITFEEDER REELS

- On/Off auto trip bait feeding system
- Multi-disc, Japanese oiled felt drag system
- 6BB + 1RB stainless steel bearing system
- Quick-Set anti-reverse roller bearing
- Precision machine cut brass pinion gear
- CFR: Cyclonic Flow Rotor technology
- Corrosion resistant frame, sideplate & rotor
- Rigid metal handle design to reduce flex
- Machined aluminum, 2-tone anodized spool
- RESII: Computer balanced Rotor Equalizing System
- Avenger ABF reels are backed by a 1-year limited warranty

BAITFEEDING SYSTEM

Okuma's baitfeeding system allows anglers to disengage their spinning reel spool & allow their bait to run freely. The baitfeeding system incorporates a secondary micro-adjustable drag system at the rear of the reel that allows for precise adjustment of the spool for bait control. In order to disengage this system simply turn the handle. The On/Off lever on the rear of the reel will automatically disengage the baitfeeding system so you can fight your fish with the main drag system.



ABF-500



ABF-1000

MODEL	GEAR RATIO	BEARINGS	WEIGHT (OZ.)	LINE RETRIEVE	MAX DRAG	MONO LINE CAPACITY	BRAIDED LINE RATING
AVENGER BAITFEEDER REELS							
ABF-500	5.0:1	6BB+1RB	6.7	21.9"	6-lbs	165/2, 85/4, 65/6	85/15, 65/20
ABF-1000	5.0:1	6BB+1RB	7.1	24.0"	6-lbs	280/2, 140/4, 100/6	180/10, 140/15
ABF-3000	5.0:1	6BB+1RB	10.1	28.0"	18-lbs	240/6, 200/8, 165/10	160/30, 140/40
ABF-4000	5.0:1	6BB+1RB	11.7	30.9"	22-lbs	285/8, 230/10, 190/12	230/30, 190/40
ABF-6000	4.5:1	6BB+1RB	17.0	31.4"	26-lbs	325/12, 220/16, 180/20	340/40, 290/50
ABF-8000	4.5:1	6BB+1RB	17.8	34.1"	26-lbs	440/12, 300/16, 245/20	460/40, 390/50

CFR CYCLONIC FLOW ROTOR



ALS-30

ALARIS

ALARIS REELS

- Multi-disc, Japanese oiled felt drag washers
- 3BB+1RB stainless steel bearings
- Quick-Set anti-reverse bearing
- Precision machine cut brass pinion gear
- Corrosion resistant frame, sideplate and rotor
- CFR: Cyclonic Flow Rotor technology
- Rigid metal handle design for strength
- Machined aluminum, 2-tone anodized spool with LCS lip
- Corrosion-resistant stainless steel bail wire
- RESII: Computer balanced Rotor Equalizing System
- Alaris reels are backed by a 1-year limited warranty

MODEL	GEAR RATIO	BEARINGS	WEIGHT (OZ.)	LINE RETRIEVE	MAX DRAG	MONO LINE CAPACITY	BRAIDED LINE RATING
ALARIS SPINNING REELS							
ALS-20	4.8:1	3BB+1RB	7.0	23.9"	11.9-lbs	280/2, 140/4, 110/6	180/10, 140/15
ALS-30	5.0:1	3BB+1RB	8.4	27.8"	15.9-lbs	240/6, 200/8, 160/10	300/15, 240/20
ALS-40	5.0:1	3BB+1RB	9.2	33.4"	17.4-lbs	260/8, 220/10, 180/12	210/30, 180/40
ALS-45	5.0:1	3BB+1RB	10.4	30.9"	18.7-lbs	280/8, 230/10, 185/12	220/30, 185/40
ALS-55	4.5:1	3BB+1RB	14.9	32.5"	30-lbs	310/12, 215/16, 180/20	185/40, 260/50
ALS-65	4.5:1	3BB+1RB	15.1	34.4"	30-lbs	400/12, 280/16, 230/20	340/50, 225/65

CFR CYCLONIC FLOW ROTOR



ROX-55

ROX

ROX REELS

- 2 Ball bearing drive for smoothness & longevity
- Oiled felt drag washers for smooth operation
- Corrosion resistant frame, sideplate and rotor
- Rigid aluminum handle design
- Durable stainless steel bail wire
- Backed by a 1-year limited warranty

MODEL	GEAR RATIO	BEARINGS	WEIGHT (OZ.)	LINE RETRIEVE	MAX DRAG	MONO LINE CAPACITY	BRAIDED LINE RATING
ROX SPINNING REELS							
ROX-20	5.0:1	2BB	7.3	23.9"	11-lbs	280/2, 140/4, 110/6	150/10, 115/15
ROX-30	5.0:1	2BB	8.8	27.0"	17.6-lbs	240/6, 200/8, 160/10	340/15, 270/20
ROX-40	5.0:1	2BB	10.7	30.1"	22.1-lbs	260/8, 220/10, 180/12	-
ROX-55	5.0:1	2BB	11.1	34.3"	26-lbs	310/12, 215/16, 180/20	330/40, 280/50



FN-500

FP-500

FE-500

Fina

FINA SPIN REELS

- Rigid, corrosion resistant frame & sideplate construction
- Multi-disc, oiled felt drag system
- Elite Models: 4BB + 1RB for ultimate smoothness
- Pro Models: feature 2BB + 1RB, and a push button foldable graphite handle arm
- Standard Models: 1 ball bearing for durability and smoothness
- Quick-Set anti-reverse roller bearing
- Precision machine cut brass pinion gear
- Machined aluminum, 2-tone anodized spool
- Fina Elite features a rigid metal handle
- Fina Elite is equipped with an EVA handle knob
- Fina reels are backed by a 1-year limited warranty

MODEL	GEAR RATIO	BEARINGS	WEIGHT (OZ.)	LINE RETRIEVE	MAX DRAG	MONO LINE CAPACITY	BRAIDED LINE RATING
FINA ELITE SPINNING REELS							
NEW FE-500	5.1:1	4BB+1RB	6.3	21.6"	6-lbs	280/2, 140/4, 100/6	200/10, 120/20
FINA PRO SPINNING REELS							
NEW FP-500	5.1:1	2BB+1RB	6.2	21.6"	6-lbs	280/2, 140/4, 100/6	200/10, 120/20
FINA SPINNING REELS							
NEW FN-500	5.1:1	1BB	5.5	21.6"	6-lbs	280/2, 140/4, 100/6	200/10, 120/20



ARIA-30a

ARIA "A"

ARIA "A" REELS

- Multi-disc, oiled felt drag washers
- 1 ball bearing drive for smoothness and durability
- Precision machine cut brass pinion gear
- Corrosion resistant body and rotor
- CFR: Cyclonic Flow Rotor technology
- Machined aluminum, anodized spool
- Corrosion-resistant stainless steel bail wire
- RESII: Computer balanced Rotor Equalizing System
- Aria reels are backed by a 1-year limited warranty

MODEL	GEAR RATIO	BEARINGS	WEIGHT (OZ.)	LINE RETRIEVE	MAX DRAG	MONO LINE CAPACITY	BRAIDED LINE RATING
ARIA "A" SPINNING REELS							
ARIA-1000a	4.8:1	1BB	6.5	24.0"	11-lbs	280/2, 140/4, 110/6	180/10, 140/15
ARIA-3000a	5.0:1	1BB	7.8	28.0"	15-lbs	240/6, 200/8, 160/10	300/15, 240/20
ARIA-C4000a†	5.0:1	1BB	8.3	33.5"	18-lbs	260/8, 220/10, 180/12	210/30, 180/40
ARIA-5000a	5.0:1	1BB	9.4	31.1"	20-lbs	295/10, 240/12, 210/14	240/40, 210/50

† Compact Body

CFR CYCLONIC FLOW ROTOR



BAITCAST REELS

At Okuma Fishing Tackle we deliver more than fishing gear. We deliver the motivation to hit the water, the energy to maintain focus & the excitement that injects every cast with high expectations. From avid recreational angler to touring professional, Okuma baitcast reels are a step above. Find premium features like Japanese ABEC-5 spool bearings & aluminum gears as standard features in tournament models instead of aftermarket upgrades. Our selection is not simply a platform upon which to begin customization, but the best a reel can be at every price.



HAKAI

HAKAI DT LOW PROFILE BAITCAST

- LiteCast magnesium frame: corrosion resistant coating
- Corrosion Resistant sideplates for maximum durability
- 42mm oversized hardened machine cut brass main gear
- Multi-disc Stainless Steel and Carbon Hybrid drag system
- Super tuner flitespool developed by Dream Tackle Design
- Patented fliteshaft hollow stainless steel main shaft
- Built in, universal line diameter indicator
- External adjustable magnetic cast control system
- Precision C-40x carbon injection star drag
- 6BB + 1RB stainless steel bearings for ultimate smoothness
- Quick-Set anti-reverse roller bearing for solid hook sets
- Hakai reels are backed by a 3-year limited warranty



MODEL	GEAR RATIO	BEARINGS	WEIGHT (OZ.)	LINE RETRIEVE	MAX DRAG	MONO LINE CAPACITY	BRAIDED LINE RATING
HAKAI DT LOW PROFILE BAITCAST REELS							
HDT100-A	6.2:1	6BB + 1RB	5.9	25.2"	20-lbs	110/12 , 100/14 , 75/16	140/30, 90/50
HDT100H-A	7.3:1	6BB + 1RB	5.9	29.9"	20-lbs	110/12 , 100/14 , 75/16	140/30, 90/50
HDT100X-A	8.1:1	6BB + 1RB	6.0	33.0"	20-lbs	110/12 , 100/14 , 75/16	140/30, 90/50
HDT101-A*	6.2:1	6BB + 1RB	5.9	25.2"	20-lbs	110/12 , 100/14 , 75/16	140/30, 90/50
HDT101H-A*	7.3:1	6BB + 1RB	5.9	29.9"	20-lbs	110/12 , 100/14 , 75/16	140/30, 90/50
HDT101X-A*	8.1:1	6BB + 1RB	6.0	33.0"	20-lbs	110/12 , 100/14 , 75/16	140/30, 90/50

*Left Handed Retrieve † Shallow Spool

FLITE **FLITE**
SPOOL SHAFT

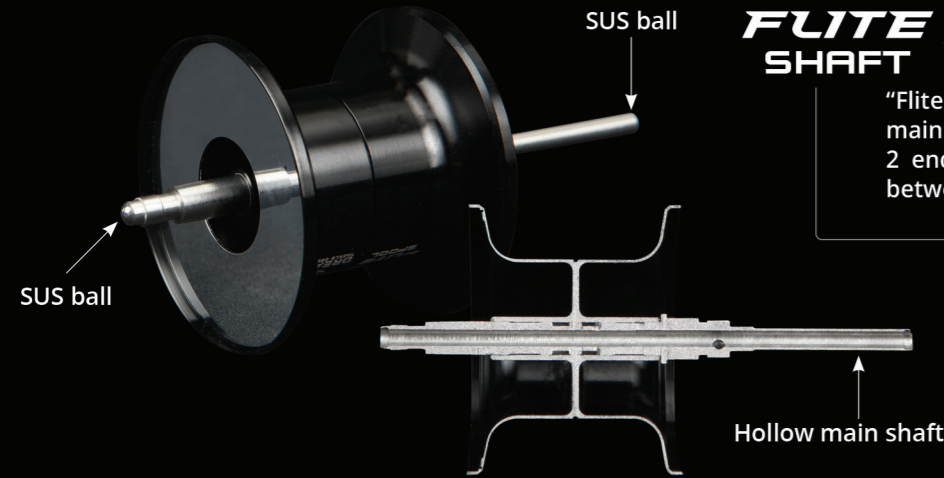

FLITE SHAFT

"Flite shaft": Patented hollow stainless steel main shaft with precision SUS balls pressed on 2 ends. Providing the perfect balance point between weight, strength and smoothness.

FLITE SPOOL

Flight spool is a Dream Tackle Design allowing Okuma to offer a super tuned spool, 33 mm O/D, 0.4mm uniform thickness. Spool weights only 9.5g (0.33oz) and was developed for long distance casting as well as finesse style fishing.



UNIVERSAL LINE DIAM. INDICATOR

Always know what line you spooled on your reel when you pick it up.

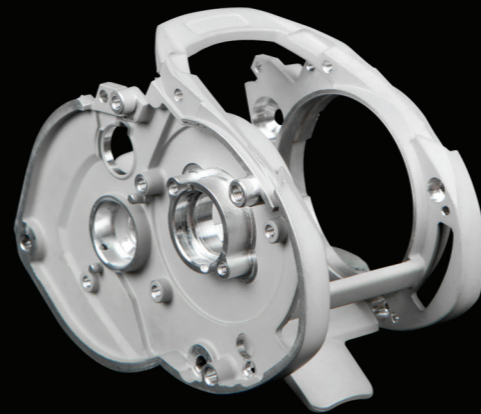
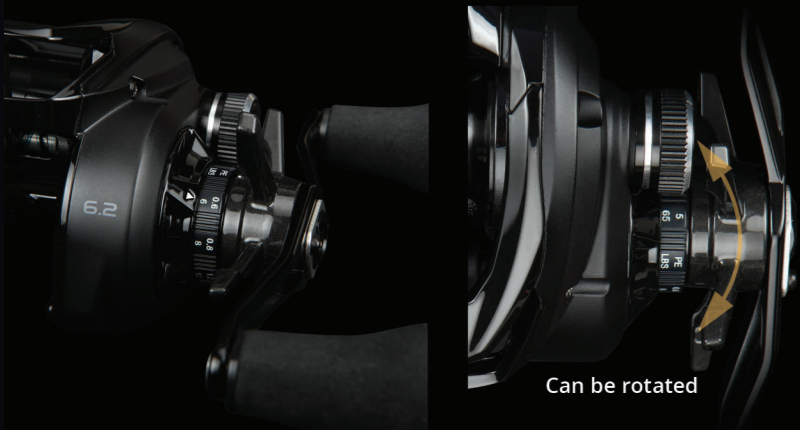

LITECAST

"LiteCast" Magnesium frame with extra ordinary treatment for corrosion resistance. Extra compact body, only 167g(5.9oz).

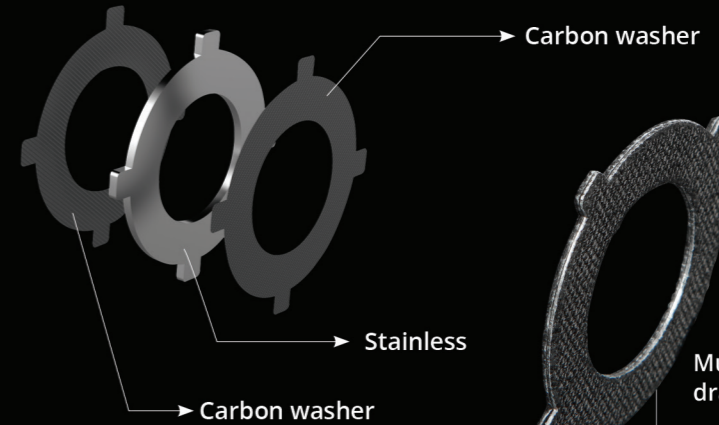

Multi-disc, Stainless steel & Carbon Hybrid drag washers, up to 9kg(20lbs) max drag.

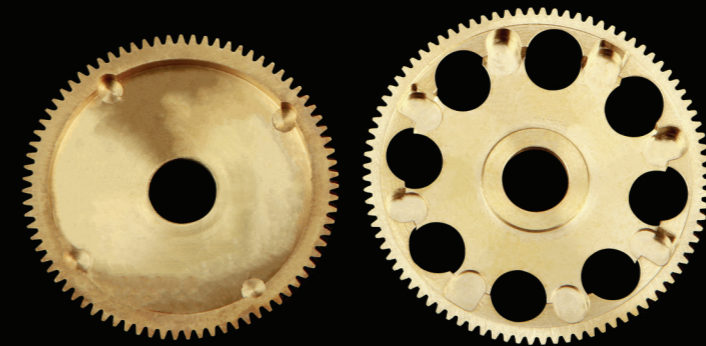

OVERSIZE MAIN GEAR

42mm oversized hardened brass main gear. Multi-disc, stainless-steel and carbon fiber hybrid drag washers for maximum drag output up to 9kg (20lbs).

KOMODO SS

KOMODO SS LOW PROFILE BAITCAST

- Stainless steel main gear for ultimate power & strength
- Precision machine cut stainless steel pinion gear
- Heavy-duty stainless-steel drive & spool shafts
- ALC: Rigid diecast aluminum frame & sideplates
- CRC: Corrosion-Resistant Coating process
- A6061-T6 machined aluminum, anodized spool
- Multi-disc high output Carbonite drag system
- Micro-click drag star for precise drag settings
- 350 size: 6HPB+1RB corrosion resistant stainless-steel bearings
- 450 size: 7HPB+1RB corrosion resistant stainless-steel bearings
- Precision Japanese ABEC-5 spool bearings
- Dual anti-reverse 350/450 sizes for maximum reliability
- Quick-Set anti-reverse roller bearing
- 6-pin Velocity Control casting system
- 350/450 sizes: Synchronized levelwind optimized for braided line
- Zirconium line guide inserts for use with braided line
- Available in both right & left-handle retrieve
- 350/450 Sizes: On/Off clicker for trolling, chunking or bait fishing
- Komodo SS reels are backed by a 3-year limited warranty



MODEL	GEAR RATIO	BEARINGS	WEIGHT (OZ.)	LINE RETRIEVE	MAX DRAG	MONO LINE CAPACITY	BRAIDED LINE RATING
KOMODO SS LOW PROFILE BAITCAST REELS							
KDS-273	7.3:1	6BB + 1RB	7.8	31.5"	20-lbs	255/10, 170/12, 135/14	185/50, 125/65
KDS-364	6.4:1	6HPB + 1RB	10.9	31"	25-lbs	250/12, 230/14, 150/20	230/50, 150/65
NEW KDS-371	7.1:1	6 HPB + 1RB	10.9	34.3"	25-lbs	250/12, 230/14, 150/20	230/50, 150/65
KDS-463	6.3:1	7HPB + 1RB	15.9	33.5"	30-lbs	290/14, 220/20, 130/30	300/50, 200/65
KDS-471	7.1:1	7HPB + 1RB	15.9	37.7"	30-lbs	290/14, 220/20, 130/30	300/50, 200/65
KDS-364P [†]	6.4:1	6HPB + 1RB	11.6	31"	25-lbs	250/12, 230/14, 150/20	230/50, 150/65
KDS-463P [†]	6.3:1	7HPB + 1RB	16.5	33.5"	30-lbs	290/14, 220/20, 130/30	300/50, 200/65
KDS-471P [†]	7.1:1	7HPB + 1RB	16.5	37.7"	30-lbs	290/14, 220/20, 130/30	300/50, 200/65
KDS-273LX*	7.3:1	6BB + 1RB	7.8	31.5"	20-lbs	255/10, 170/12, 135/14	185/50, 125/65
KDS-364LX*	6.4:1	6HPB + 1RB	10.9	31"	25-lbs	250/12, 230/14, 150/20	230/50, 150/65
NEW KDS-371LX*	7.1:1	6 HPB + 1RB	10.9	34.3"	25-lbs	250/12, 230/14, 150/20	230/50, 150/65
KDS-463LX*	6.3:1	7HPB + 1RB	15.9	33.5"	30-lbs	290/14, 220/20, 130/30	300/50, 200/65
KDS-364PLX* [†]	6.4:1	6HPB + 1RB	11.6	31"	25-lbs	250/12, 230/14, 150/20	230/50, 150/65
KDS-463PLX* [†]	6.3:1	7HPB + 1RB	16.5	33.5"	30-lbs	290/14, 220/20, 130/30	300/50, 200/65

*Left Handed Retrieve † Power Handle



KDS-463P

CITRIX

CITRIX LOW PROFILE BAITCAST

- ALC: Rigid diecast aluminum frame
- A6061-T6 machined aluminum, anodized large arbor spool
- Multi-disc Carbonite drag system
- 9BB+1RB bearing drive system
- Micro-click drag star for precise drag settings
- External adjustable centrifugal cast control system
- Quick-Set anti-reverse roller bearing
- Corrosion resistant palm sideplate
- Easy change palm sideplate access port
- Ergonomic handle design allows cranking closer to body
- Zirconium line guide inserts for use with braided line
- Citrix reels are backed by a 1-year limited warranty



MODEL	GEAR RATIO	BEARINGS	WEIGHT (OZ.)	LINE RETRIEVE	MAX DRAG	MONO LINE CAPACITY	BRAIDED LINE RATING
CITRIX LOW PROFILE BAITCAST REELS							
Ci-364a	6.4:1	7BB + 1RB	11.0	31"	25-lbs	250/12, 230/14, 150/20	230/50, 150/65
Ci-364Pa [†]	6.4:1	7BB + 1RB	11.0	31"	25-lbs	250/12, 230/14, 150/20	230/50, 150/65
Ci-364LXa*	6.4:1	7BB + 1RB	11.0	31"	25-lbs	250/12, 230/14, 150/20	230/50, 150/65
Ci-364PLXa* [†]	6.4:1	7BB + 1RB	11.0	31"	25-lbs	250/12, 230/14, 150/20	230/50, 150/65

*Left Handed Retrieve † Power Handle

Ceymar ODT

CEYMAR ODT BAITCAST REELS

- Rigid, corrosion resistant frame & sideplate construction
- 5BB + 1RB precision stainless steel bearing drive system
- Quick Set anti-reverse bearing for solid hook sets
- Precision cut, high strength brass main & pinion gears
- Externally adjustable magnetic cast control system
- 33.5mm machined aluminum, black anodized spool
- Multi-disc drag washers for consistent performance
- Double paddle, 95mm aluminum swept handle arm
- Ceymar ODG reels are backed by a 1-year limited warranty



MODEL	GEAR RATIO	BEARINGS	WEIGHT (OZ.)	LINE RETRIEVE	MAX DRAG	MONO LINE CAPACITY	BRAIDED LINE RATING
CEYMAR ODT LOW PROFILE BAITCAST REELS							
NEW ODT-100HA	7.2:1	5BB + 1RB	7.0	29.9"	11-lbs	120/12, 110/14, 90/16	155/30, 100/50
NEW ODT-101HA*	7.2:1	5BB + 1RB	7.0	29.9"	11-lbs	120/12, 110/14, 90/16	155/30, 100/50

*Left Handed Retrieve



TGT GRIP
Traction Grip Technology

SPOOL ACCESS PORT

This unique new design can be found on Okuma's low profile baitcast reels. The Spool Access Port allows for quick access to the spool by simply sliding the lock/unlock lever on the sideplate opposite the handle. This system allows for quick spool changes, but more importantly it allows quick access for adjusting the Velocity Control System.

SERRANO

SERRANO LOW PROFILE BAITCAST

- Rigid, corrosion resistant frame & sideplate construction
- 6BB + 1RB precision stainless steel bearing drive system
- Quick Set anti-reverse bearing for solid hook sets
- Precision cut, high strength brass main & pinion gears
- Externally adjustable magnetic cast control system
- 33.5mm machined aluminum, black anodized spool
- Multi-disc drag washers for consistent performance
- Double paddle, 95mm aluminum swept handle arm
- TGT Grip: Traction Grip Technology
- Serrano reels are backed by a 1-year limited warranty



MODEL	GEAR RATIO	BEARINGS	WEIGHT (OZ.)	LINE RETRIEVE	MAX DRAG	MONO LINE CAPACITY	BRAIDED LINE RATING
SERRANO LOW PROFILE BAITCAST REELS							
SRN100-A	6.5:1	6BB+1RB	7.0	26.8"	11-lbs	120/12, 110/14, 90/16	155/30, 100/50
SRN100H-A	7.2:1	6BB+1RB	7.0	29.9"	11-lbs	120/12, 110/14, 90/16	155/30, 100/50
SRN101-A*	6.5:1	6BB+1RB	7.0	26.8"	11-lbs	120/12, 110/14, 90/16	155/30, 100/50

*Left Handed Retrieve

EPIXOR

EPIXOR LOW PROFILE BAITCAST

- Corrosion resistant frame & sideplates
- Two-toned anodized, machined aluminum spool
- Multi-disc carbon fiber & stainless steel drag system
- Precision machine cut brass main & pinion gears
- 6BB + 1RB stainless steel bearing drive system
- External adjustable magnetic cast control system
- Quick-Set anti-reverse roller bearing
- Easy change palm sideplate access port
- Available in both right & left hand retrieve
- EPIXOR reels are backed by a 1-year limited warranty



MODEL	GEAR RATIO	BEARINGS	WEIGHT (OZ.)	LINE RETRIEVE	MAX DRAG	MONO LINE CAPACITY	BRAIDED LINE RATING
EPIXOR LOW PROFILE BAITCAST REELS							
NEW EPXT-100-A	6.5:1	6BB+1RB	7.0	26.8"	11-lbs	120/12, 110/14, 90/16	155/30, 100/50
NEW EPXT-100H-A	7.2:1	6BB+1RB	7.0	29.9"	11-lbs	120/12, 110/14, 90/16	155/30, 100/50
NEW EPXT-101H-A*	7.2:1	6BB+1RB	7.0	29.9"	11-lbs	120/12, 110/14, 90/16	155/30, 100/50

*Left Handle Retrieve

HALOGEN LOW PROFILE BAITCAST

- Corrosion resistant frame and sideplates
- 5BB + 1RB precision stainless steel bearing drive system
- Quick Set anti-reverse bearing for solid hook sets
- Precision cut, high strength brass main and pinion gears
- Externally adjustable magnetic cast control system
- 33.5mm machined aluminum, black anodized spool
- Multi-disc drags washers for consistent performance
- Halogen reels are backed by a 1-year limited warranty



MODEL	GEAR RATIO	BEARINGS	WEIGHT (OZ.)	LINE RETRIEVE	MAX DRAG	MONO LINE CAPACITY	BRAIDED LINE RATING
HALOGEN LOW PROFILE BAITCAST REELS							
HG-100-A	6.5:1	5BB+1RB	7.0	26.8"	11-lbs	120/12, 110/14, 90/16	155/30, 100/50
HG-100H-A	7.2:1	5BB+1RB	7.0	29.9"	11-lbs	120/12, 110/14, 90/16	155/30, 100/50
HG-101-A*	6.5:1	5BB+1RB	7.0	26.8"	11-lbs	120/12, 110/14, 90/16	155/30, 100/50
HG-101H-A*	7.2:2	5BB+1RB	7.0	29.9"	11-lbs	120/12, 110/14, 90/16	155/30, 100/50

*Left Handed Retrieve

CEYMAR LOW PROFILE BAITCAST

- Corrosion resistant frame & sideplates
- A6061-T6 machined aluminum, anodized U-shaped spool
- Multi-disc composite drag system
- 6BB+1RB bearing drive system
- External adjustable magnetic cast control system
- Quick-Set anti-reverse roller bearing
- Sideplate access port for quick spool changes
- Ergonomic handle design allows cranking closer to body
- Backed by a 1-year limited warranty



MODEL	GEAR RATIO	BEARINGS	WEIGHT (OZ.)	LINE RETRIEVE	MAX DRAG	MONO LINE CAPACITY	BRAIDED LINE RATING
CEYMAR LOW PROFILE BAITCAST REELS							
C-266W-CL	6.6:1	6BB+1RB	7.6	28.5"	11-lbs	160/10, 130/12, 95/14	130/30, 90/50



CONVENTIONAL REELS

Leadership, innovation & value are not simply concepts for board rooms & PowerPoint presentations. At Okuma Fishing Tackle, these guiding principles are embodied & evident in every product. Our engineering embraces modern fishing lines & the latest in fishing rod construction to develop reels that deliver the most power with minimal weight. We're redefining the relationship between the size of a reel & the size of the fish in order to take larger trophies on smaller reels. Our reels don't intrude on the experience, they enhance it.

TESORO

TESORO STAR DRAG REELS

- High Speed 6.2:1 gear ratio
- 6061-T6 machined aluminum frame, sideplate & spool
- 17-4 grade stainless steel helical cut gearing
- Multi-disc Carbonite drag system with Cal's drag grease
- CRC: Corrosion-Resistant Coating Process
- Swept aluminum star for increased ergonomics
- Anodized aluminum swept handle reduces wobble while cranking
- 4HPB + 1RB corrosion resistant bearings, spool bearing with TSI oil
- Ergo grip handle knob with anodized aluminum handle arm
- Dual anti-reverse (mechanical & roller bearing)
- XL Gearing: Drop down gear box
- Quick-Set ant-reverse bearing allows for zero back play in handle
- MSS: Mechanical Stabilizing System for increased durability
- Self-lubricating gear system, all models
- Tesoro reels are backed by a 3-year limited warranty



TSR-12S

MODEL	GEAR RATIO	BEARINGS	WEIGHT (OZ.)	LINE RETRIEVE	MAX DRAG	MONO LINE CAPACITY	BRAIDED LINE RATING
TESORO STAR DRAG REELS							
TSR-5NS	6.2:1	4HPB + 1RB	15.7	39"	20-lbs	415/15, 305/20, 220/25	350/40, 250/60
TSR-5S	6.2:1	4HPB + 1RB	16.6	39"	20-lbs	355/20, 245/25, 205/30	465/50
TSR-10S	6.2:1	4HPB + 1RB	19.0	46"	22-lbs	320/25, 245/30, 150/40	495/50
TSR-12S	6.2:1	4HPB + 1RB	19.2	46"	22-lbs	405/25, 295/30, 185/40	475/65

CORTEZ

CORTEZ STAR DRAG REELS

- Corrosion resistant frame and sideplates
- Machined aluminum, anodized spool
- Multi-disc Carbonite drag system
- Forged aluminum, anodized star
- MCS: External magnetic cast control system
- Anodized aluminum swept handle reduces wobble while cranking
- MSS: Mechanical Stabilizing System for increased durability
- 4BB+1RB stainless steel bearings
- Ergo grip handle knob
- Dual anti-reverse system (mechanical & roller bearing)
- XL Gearing: Drop down gear box
- Quick-Set anti-reverse roller bearing
- Self-lubricating gear system, all models
- Cortez reels are backed by a 1-year limited warranty



MCS

Okuma's Magnetic Control System is a fully-sealed, 100% waterproof cast control system that reduces backlash & improves casting distance by utilizing the magnetic field generated by the high RPM spinning of the spool during casting. The magnetic field is influenced by the adjustable cast control magnet which exerts an opposing force & allows for minute & accurate adjustments.



CZ-5CSa

MODEL	GEAR RATIO	BEARINGS	WEIGHT (OZ.)	LINE RETRIEVE	MAX DRAG	MONO LINE CAPACITY	BRAIDED LINE RATING
CORTEZ STAR DRAG REELS							
CZ-5CSa	6.2:1	4BB+1RB	14.0	38"	15-lbs	410/14, 305/18, 270/20	365/50, 240/65
CZ-10CSa	6.2:1	4BB+1RB	17.6	43"	18-lbs	260/25, 350/20, 430/15	485/50, 325/65
CZ-12CSa	6.2:1	4BB+1RB	18.4	43"	18-lbs	300/30, 400/25, 540/20	425/80, 350/100

Cold Water SS

COLD WATER SS LOW PROFILE LINE COUNTER

- Stainless steel main gear for ultimate power & strength
- Precision machine cut stainless steel pinion gear
- Heavy duty stainless steel drive shaft & spool shaft
- ALC Rigid diecast aluminum frame & handle sideplate
- Mechanical line counter function measures in feet
- CVT: Clear View Technology anti-fogging line counter
- 3BB + 1RB stainless steel bearings for maximum performance
- CRC: Corrosion Resistant Coating process
- Automatic trip, spool engagement mechanism
- A6061-T6 machined aluminum, anodized spool
- Multi-disc high output Carbonite drag system
- Aluminum ratcheting drag star for precision adjustments
- Dual anti-reverse for maximum reliability
- Synchronized levelwind optimized for braided line
- Available in both right & left handle retrieve
- On/Off clicker perfect for all trolling applications
- Coldwater SS reels are backed by a 1-year limited warranty



CWS-354DLX



CWS-354D

MODEL	GEAR RATIO	BEARINGS	WEIGHT (OZ.)	LINE RETRIEVE	MAX DRAG	MONO LINE CAPACITY	BRAIDED LINE RATING
COLDWATER SS LOW PROFILE LINE COUNTER REELS							
CWS-354D	5.4:1	3BB + 1RB	12.3	26.1"	25-lbs	250/12, 230/14, 150/20	230/50, 150/65
CWS-354DLX*	5.4:1	3BB + 1RB	12.3	26.1"	25-lbs	250/12, 230/14, 150/20	230/50, 150/65

*Left Handle Retrieve

Cold Water

LOW PROFILE LINE COUNTER

COLD WATER LOW PROFILE LINE COUNTER

- ALC: Rigid diecast aluminum frame & handle sideplate
- Multi-disc, Carbonite drag system
- Balanced aluminum handle arm with Ergo Grip handle knobs
- 3BB + 1RB Stainless steel ball bearings
- Quick-Set anti-reverse roller bearing
- Oversized machine cut brass XL drive & pinion gears
- Machined aluminum, two tone anodized spool
- Mechanical line counter function measures in feet
- CVT: Clear View Technology anti-fogging line counter
- Aluminum ratcheting drag star for precision drag settings
- Automatic trip, spool engaging mechanism
- 5.4:1 gear ratio available in both left & right handle retrieve
- Cold Water LP Line Counter Reels are backed by a 1-year limited warranty



CW-354D



MODEL	GEAR RATIO	BEARINGS	WEIGHT (OZ.)	LINE RETRIEVE	MAX DRAG	MONO LINE CAPACITY	BRAIDED LINE RATING
COLD WATER LOW PROFILE LINE COUNTER REELS							
CW-354D	5.4:1	3BB+1RB	12.5	26.1"	25-lbs	250/12, 230/14, 150/20	230/50, 150/65
CW-354DLX*	5.4:1	3BB+1RB	12.7	26.1"	25-lbs	250/12, 230/14, 150/20	230/50, 150/65

*Left Handed Retrieve

Cold Water

COLD WATER LINE COUNTER REELS

- Lightweight corrosion resistant frame & sideplates
- Multi-disc, Carbonite drag system
- Aluminum handle arm with Ergo grip handle knobs
- 2BB + 1RB Stainless steel ball bearings
- Quick-set anti-reverse roller bearing
- Oversized machine cut brass XL drive & pinion gears
- Self-lubricating gearing system, all models
- Speed Lock pinion gear system, all models
- Machined aluminum, two tone anodized spool
- Dual anti-reverse system. (Mechanical & roller bearing)
- Mechanical line counter function measures in feet
- CVT: Clear View Technology anti-fogging line counter
- Aluminum ratcheting drag star for precision drag settings
- Wide Mouth levelwind: Clearance for copper lines
- Automatic trip spool engaging mechanism
- MSS: Mechanical Stabilizing System for increased durability
- DLX represent left hand crank line counter models
- Cold water Line counter reels are backed by a 1-year limited warranty

COLD WATER WIRE LINE REELS

- Designed with high speed gear ratios for increased line pickup
- 303/453DS models are high speed line counter reels
- 553LS is a large diameter high speed levelwind reel (no counter)
- Oversized brass XL gearing system
- Multi-disc Carbonite drag washers for maximum efficiency
- 2HPB + 1RB corrosion resistant stainless steel bearings
- Dual anti-reverse system for maximum strength & reliability
- Quick-Set stainless steel anti-reverse roller bearing
- Machined aluminum, anodized spool
- Speed Lock pinion gear system for instant engagement
- Ergo grip handle knob for increased comfort
- Wide Mouth levelwind: Increased knots clearance
- Silent retrieve system for increased smoothness
- MSS: Mechanical Stabilizing System for precise alignment
- XL gearing: Drop down gear box for maximum gear sizing
- Self-lubricating gear system for maximum heat dissipation
- Cold water DS/LS reels are backed by a 1-year limited warranty



CW-303D



CW-203D-LE



CW-553LS



CW-553LS

MODEL	GEAR RATIO	BEARINGS	WEIGHT (OZ.)	LINE RETRIEVE	MAX DRAG	MONO LINE CAPACITY	BRAIDED LINE RATING
COLD WATER LINE COUNTERS							
CW-153D	5.1:1	2BB+1RB	14.6	23"	18-lbs	330/10, 290/12, 240/14	175/65, 160/80
CW-203D	5.1:1	2BB+1RB	15.0	23"	18-lbs	290/14, 230/18, 210/20	220/65, 200/80
CW-303D	4.2:1	2BB+1RB	20.0	24"	20-lbs	510/15, 420/20, 310/25	425/65, 400/80
CW-453D	4.2:1	2BB+1RB	21.8	26"	20-lbs	580/20, 430/25, 330/30	590/65, 550/80
CW-153DLX*	5.1:1	2BB+1RB	14.6	23"	18-lbs	330/10, 290/12, 240/14	175/65, 160/80
CW-203DLX*	5.1:1	2BB+1RB	15.0	23"	18-lbs	290/14, 230/18, 210/20	220/65, 200/80
CW-303DLX*	4.2:1	2BB+1RB	20.0	24"	20-lbs	510/15, 420/20, 310/25	425/65, 400/80
COLD WATER LINE COUNTERS - SPECIAL EDITION							
CW-203D-LE	5.1:1	2BB+1RB	15.0	23"	18-lbs	290/14, 230/18, 210/20	220/65, 200/80
CW-203DLX-LE*	5.1:1	2BB+1RB	15.0	23"	18-lbs	290/14, 230/18, 210/20	220/65, 200/80
COLD WATER WIRE LINE REELS							
CW-303DS	6.2:1	2BB+1RB	20.1	37.1"	20-lbs	510/15, 420/20, 310/25	425/65, 400/80
CW-453DS	6.2:1	2BB+1RB	22.0	41.3"	20-lbs	580/20, 430/25, 330/30	590/65, 550/80
CW-553LS	4.7:1	2BB+1RB	30.7	40.7"	22-lbs	680/25, 520/30, 440/40	930/65, 850/80

*Left Handed Retrieve

CONVECTOR

CONVECTOR REELS

- Lightweight corrosion resistant frame & sideplates
- Machined aluminum, gun smoke anodized spool
- Stainless steel reinforcing sideplate rings
- Multi-disc Carbonite drag system
- Ratcheting drag star for precise drag settings
- 2BB+1RB Stainless steel bearing drive system
- Quick-Set anti-reverse roller bearing
- Dual anti-reverse system. (Mechanical & roller bearing)
- Speed Lock pinion gear system
- Durable high-grade brass main & pinion gear system
- XL gearing: Drop down gear box 20, 30, 45 sizes
- Self lubricating gear system, all models
- Wide Mouth levelwind ("L" models): Clearance for copper line
- Ergo grip handle knobs featured on all models
- Stainless steel Body Armor on CV-55L
- MSS: Mechanical Stabilizing System for increased durability
- Convector star drag reels are backed by a 1-year limited warranty



CV-30L

MODEL	GEAR RATIO	BEARINGS	WEIGHT (OZ.)	LINE RETRIEVE	MAX DRAG	MONO LINE CAPACITY	BRAIDED LINE RATING
CONVECTOR REELS							
CV-20L	5.1:1	2BB+1RB	16.0	23"	18-lbs	290/14, 230/18, 210/20	220/65, 200/80
CV-30L	4.0:1	2BB+1RB	20.9	24"	20-lbs	510/15, 420/20, 310/25	425/65, 400/80
CV-45L	4.0:1	2BB+1RB	22.4	26"	20-lbs	580/20, 430/25, 330/30	590/65, 550/80
CV-55L	4.0:1	2BB+1RB	34.7	34"	22-lbs	470/25, 360/30, 310/40	645/65, 590/80

CONVECTOR LOW PROFILE REELS

- Precision machine cut brass main & pinion gears
- Mechanical line counter function measures in feet
- CVT: Clear View Technology anti-fogging line counter
- 2HPB + 1RB corrosion resistant bearings
- Automatic trip, spool engagement mechanism
- A6061-T6 machined aluminum, anodized spool
- Multi-disc high output Carbonite drag system
- Quick-Set anti-reverse roller bearing
- Synchronized levelwind optimized for braided line
- Quick Drop, switch for precision lure/bait placement
- Available in both right & left-hand retrieve
- On/Off clicker perfect for all trolling applications
- Convector reels are backed by a 1-year limited warranty



CV-354D

MODEL	GEAR RATIO	BEARINGS	WEIGHT (OZ.)	LINE RETRIEVE	MAX DRAG	MONO LINE CAPACITY	BRAIDED LINE RATING
CONVECTOR LOW PROFILE REELS							
CV-163D	6.3:1	2HPB+1RB	7.9	26.8"	11-lbs	260/8, 180/12, 115/16	150/50, 100/65
CV-354D	5.4:1	2HPB+1RB	11.7	25.9"	22-lbs	300/12, 260/14, 160/20	230/50, 150/65
CV-163DLX*	6.3:1	2HPB+1RB	7.9	26.8"	11-lbs	260/8, 180/12, 115/16	150/50, 100/65
CV-354DLX*	5.4:1	2HPB+1RB	11.7	25.9"	22-lbs	300/12, 260/14, 160/20	230/50, 150/65

*Left Handle Retrieve

CONVECTOR

CONVECTOR LINE COUNTER REELS

- Lightweight corrosion resistant frame & sideplates
- Machined aluminum, gun smoke anodized spool
- Stainless steel reinforced sideplate rings
- Mechanical line counter function measures in feet
- Multi-disc Carbonite drag system
- Ratcheting drag star for precise drag settings
- 2BB+1RB Stainless steel bearing drive system
- Quick-Set anti-reverse roller bearing
- Dual anti-reverse system. (Mechanical & roller bearing)
- Speed Lock pinion gear system
- Durable high-grade brass main & pinion gear system
- XL gearing: Drop down gear box on all models
- Self lubricating gear system, all models
- Wide Mouth levelwind: Clearance for copper line
- Spool stabilizing system for increased durability
- Ergo grip handle knobs featured on all models
- DLX represents left hand crank line counter models
- MSS: Mechanical Stabilizing System for increased durability
- Convector Line Counter reels are backed by a 1-year limited warranty

MODEL	GEAR RATIO	BEARINGS	WEIGHT (OZ.)	LINE RETRIEVE	MAX DRAG	MONO LINE CAPACITY	BRAIDED LINE RATING
CONVECTOR LINE COUNTER REELS							
CV-15D	5.1:1	2BB+1RB	15.8	23"	18-lbs	330/10, 290/12, 240/14	175/65, 160/80
CV-20D	5.1:1	2BB+1RB	16.5	23"	18-lbs	290/14, 230/18, 210/20	220/65, 200/80
CV-30D	4.0:1	2BB+1RB	21.5	24"	20-lbs	510/15, 420/20, 310/25	425/65, 400/80
CV-45D	4.0:1	2BB+1RB	22.9	26"	20-lbs	580/20, 430/25, 330/30	590/65, 550/80
CV-30Ds [†]	6.2:1	2BB+1RB	20.6	37.1"	20-lbs	510/15, 420/20, 310/25	425/65, 400/80
CV-45Ds [†]	6.2:1	2BB+1RB	22.5	41.3"	20-lbs	580/20, 430/25, 330/30	590/65, 550/80
CV-20DLX*	5.1:1	2BB+1RB	16.5	23"	18-lbs	290/14, 230/18, 210/20	220/65, 200/80
CV-30DLX*	4.0:1	2BB+1RB	21.5	24"	20-lbs	510/15, 420/20, 310/25	425/65, 400/80

*Left Handle Retrieve †High Speed



CV-20DLX

CV-30D

MAGDA^{PRO} Line Counter

MAGDA PRO LINE COUNTER REELS

- Lightweight, corrosion-resistant frame & sideplates
- Corrosion resistant spool design
- Mechanical line counter function measures in feet
- Multi-disc Carbonite drag system
- 2 Stainless steel ball bearing
- 16-point anti-reverse for improved hookups
- Line counter screw port for improved air access
- Durable Machine cut brass gearing
- Self-Lubricating Gear System, all models
- 20 – 45 sizes with Ergo grip handle knob design
- 15-size features a twin paddle handle configuration
- Automatic trip spool engaging mechanism
- Stainless steel levelwind line guide system
- DLXT represents left hand crank models
- Magda Pro reels are backed by a 1-year limited warranty



MA-45DXT

MODEL	GEAR RATIO	BEARINGS	WEIGHT (OZ.)	LINE RETRIEVE	MAX DRAG	MONO LINE CAPACITY	BRAIDED LINE RATING
MAGDA PRO LINE COUNTER REELS							
MA-15DXT-T	5.1:1	2BB	12.6	23"	15-lbs	330/10, 290/12, 240/14	175/65, 160/80
MA-20DXT	5.1:1	2BB	13.8	23"	15-lbs	290/14, 230/18, 210/20	220/65, 200/80
MA-30DXT	4.0:1	2BB	16.4	24"	17-lbs	510/15, 420/20, 310/25	425/65, 400/80
MA-45DXT	4.0:1	2BB	17.4	26"	18-lbs	580/20, 430/25, 330/30	590/65, 550/80
MA-20DLX*	5.1:1	2BB	13.2	23"	15-lbs	290/14, 230/18, 210/20	220/65, 200/80
MA-30DLX*	4.0:1	2BB	16.5	24"	17-lbs	510/15, 420/20, 310/25	425/65, 400/80

*Left Handle Retrieve

CLASSIC PRO

CLASSIC PRO XP REELS

- Lightweight corrosion resistant frame & sideplates
- Machined aluminum, anodized spool
- Ported graphite frame design
- Stainless steel reel foot for strength
- Dependable multi-disc Rulidium drag system
- Classic Pro XP features 2 ball bearings
- Machine cut brass & stainless steel gearing
- Aluminum power handle with T-style knobs
- Self lubricating gear system
- Stainless steel levelwind line guide system
- Backed by a 1-year warranty



XP-302La

MODEL	GEAR RATIO	BEARINGS	WEIGHT (OZ.)	LINE RETRIEVE	MAX DRAG	MONO LINE CAPACITY	BRAIDED LINE RATING
CLASSIC PRO XP REELS							
XP-202La	5.1:1	2BB	12.8	23"	12-lbs	290/14, 230/18, 210/20	220/65, 200/80
XP-302La	3.8:1	2BB	15.6	24"	17-lbs	510/15, 420/20, 310/25	425/65, 400/80
XP-452La	3.8:1	2BB	16.8	25"	18-lbs	580/20, 430/25, 330/30	590/65, 550/80

CLASSIC CLX REELS

- Lightweight corrosion resistant frame & sideplates
- Corrosion resistant spool design
- Lightweight corrosion resistant, ported frame
- Stainless steel reel foot for strength
- Dependable multi-disc Rulidium drag system
- CLX features a bushing drive
- Aluminum power handle with T-style knobs
- Self lubricating gear system
- Stainless steel levelwind line guide system
- CLX reels are backed by a 1-year limited warranty



CLX-200La

MODEL	GEAR RATIO	BEARINGS	WEIGHT (OZ.)	LINE RETRIEVE	MAX DRAG	MONO LINE CAPACITY	BRAIDED LINE RATING
CLASSIC CLX REELS							
CLX-200La	5.1:1	Bushing	12.0	23"	12-lbs	290/14, 230/18, 210/20	220/65, 200/80
CLX-300La	3.8:1	Bushing	15.0	24"	17-lbs	510/15, 420/20, 310/25	425/65, 400/80
CLX-450La	3.8:1	Bushing	16.0	25"	18-lbs	580/20, 430/25, 330/30	590/65, 550/80



MAKAIRA

DUAL FORCE DRAG SYSTEM

The specialized carbon DFD or Dual Force Drag system used on all Makaira reels was specifically engineered to be mounted in the right side of the spool in order to bring all the mechanical workings closer together to maximize alignment & durability. The farther mechanical parts are separated the more opportunity there is for tolerance error & flexing which causes parts alignment issues. The DFD principal was specifically designed around the "Pull Bar Drag System". The major advantage to a "Pull Bar Drag System" is that the drag is being pulled rather than pushed. The most common type of lever drag in the industry is the "Push Bar Drag System". The Push Bar System places heavy pressure on the left sideplate & utilizes the frame for overall stability which is a fatal flaw in this type of design. This pressure creates frame flex, reducing drag pressure & causing tolerance alignment issues. This problem is further exaggerated on open top designs from other companies. One of the major benefits to the pull bar design is that there is no pressure placed on the frame. Therefore, our open top frame designs will not suffer frame flex found in our competitors reels.

This highly efficient drag system was designed & engineered by Tiburon Engineering USA to increase maximum drag pressure, reduce side load pressure on ball bearings & improve heat dissipation for long term smoothness over extended periods. This Okuma DFD is considered a wet drag system comprised of two carbon fiber drag washers that are sandwiched together & bonded with a fiber glass core. Pure carbon washers are coated with a thin layer of Cal Sheet's Universal drag grease for virtually zero start up inertia. These washers are compressed by two precision ground 17-4 grade stainless steel drag plates that have been ground flat then polished for maximum smoothness. These stainless steel friction drag plates have a minimum 32 Rockwell hardness allowing for high-end drag settings & consistently smooth drag performance at all ranges. The drag system is secured to the right side of the spool by a 6061-T6 grade aluminum cover that features Type-II anodizing for maximum alignment, strength & corrosion resistance.

MAKAIRA



MAKAIRA LEVER DRAG REELS

- 6061-T6 machined aluminum frame with forged sideplates
- 17-4 grade stainless steel gearing
- Helical cut gears for increased torque, smoothness & improved gear meshing
- Makaira reels all feature two-speed gearing systems
- Gold anodized two-speed gear shifter housing
- Cold forged, Type-II anodized, machined aluminum spool
- CRC: Corrosion Resistant Coating process
- Patented spool pin system for use with braided or mono lines
- Carbonite Dual Force drag system featuring Cal's universal drag grease
- Custom designed thrust bearing: Alleviates side load on heavy drag settings
- 4-pcs ABEC-5 precision Sapporo stainless steel ball bearings
- MK-80WII features 6-pcs of Sapporo ball bearings
- Double-dog, proprietary silent anti-reverse system
- Ratcheting drag lever & pre-set knob for precise drag setting
- Patented T-Bar handle with Easy Roll graphite insert on all models
- Heavy duty stainless steel ratcheting clicker system
- Heavy duty, 17-4 grade stainless steel drive & spool shafts
- Type-II gold anodized frame, sideplates, spool, drag lever & handle
- Open top frame design on 10II, 15TII, 16II, 20II, & 50II
- Lug & plug system on all open top reel models
- Machined thumb rest on rear cross bar for improved ergonomics
- Forged aluminum full hard anodized reel foot & reel clamp
- Machine-etched marlin logo on left sideplate
- Precision placement of drain holes maximizes water removal from reel
- Special screw ports around sideplate screws reduces water/corrosion buildup
- Makaira lever drag reels are backed by a 5-year limited warranty



MK-10II



MK-20II



MK-30II



MK-50II



MK-130WII



MODEL	GEAR RATIO	BEARINGS	WEIGHT (OZ.)	LINE RETRIEVE	MAX DRAG @ STRIKE	MAX DRAG @ FULL	MONO LINE CAPACITY	BRAIDED LINE RATING
MAKAIRA TWO-SPEED LEVER DRAG REELS								
MK-10II	4.7:1 & 2.1:1	4BB+1TB	26.1	33.5" & 15.0"	27-lbs	34-lbs	460/15, 380/20, 280/25	See Page 55
MK-15TIISEA-GOLD	4.7:1 & 2.1:1	4BB+1TB	29.0	38.9" & 17.1"	32-lbs	40-lbs	575/20, 425/25, 325/30	See Page 55
MK-16II	4.3:1 & 1.3:1	4BB+1TB	40.0	39.2" & 11.8"	34-lbs	48-lbs	870/20, 650/25, 500/30	See Page 55
MK-20II	3.8:1 & 1.7:1	4BB+1TB	45.8	39.4" & 17.5"	37-lbs	55-lbs	870/25, 660/30, 530/40	See Page 55
MK-30II*	3.8:1 & 1.7:1	4BB+1TB	50.0	39.4" & 17.5"	37-lbs	55-lbs	850/30, 700/40, 550/50	See Page 55
MK-50II	3.2:1 & 1.3:1	4BB+1TB	61.4	37.8" & 15.3"	60-lbs	85-lbs	1000/30, 650/50, 400/80	See Page 55
MK-50WII*	3.2:1 & 1.3:1	4BB+1TB	65.0	37.8" & 15.3"	60-lbs	85-lbs	900/50, 780/60, 560/80	See Page 55
MK-80WII*	3.1:1 & 1.2:1	6BB+1TB	116.0	45.7" & 20.5"	70-lbs	100-lbs	1000/80, 850/100, 660/130	See Page 55
MK-130II*	2.2:1 & 1.2:1	6BB+1TB	167-oz	39.7" & 21.7"	75-lbs	100-lbs	1570/80, 1270/100, 1000/130	See Page 55

*Frame Style: Top Crossbar

MAKAIRA

MATTE BLACK EDITION



MAKAIRA SEa MATTE BLACK LEVER DRAG REELS

- Open spool bearings with TSI-301 oil. Increases freespool 2-1/2 times.
- MK-80WIISeA-MTBLK & MK-130IISeA-MTBLK feature grease-packed spool bearings
- All non-spool bearings feature full grease pack for maximum longevity.
- Type-II Black anodized frame, sideplates, spool, drag lever & handle
- Frames have been machined out for increased clearance between spool & cross bars.
- MK-10/15T feature MK-20 size handle knobs.
- MK-20/30 feature the MK-50 handle arm & knobs
- Lower speed 1.3:1 gear ratio featured in 20/30 sizes.
- Lower speed 1.0:1 gear ratio featured in 50 size.
- Backed by a 5-year limited warranty



MK-80WIISeA-MTBLK

MK-16IISeA-MTBLK

MODEL	GEAR RATIO	BEARINGS	WEIGHT (OZ.)	LINE RETRIEVE	MAX DRAG @ STRIKE	MAX DRAG @ FULL	MONO LINE CAPACITY	BRAIDED LINE RATING
MAKAIRA SEa MATTE BLACK TWO-SPEED LEVER DRAG REELS								
MK-15IISeA-MTBLK	4.7:1 & 2.1:1	4BB+1TB	29.0	38.9" & 17.1"	32-lbs	40-lbs	575/20, 425/25, 325/30	See Page 55
MK-16IISeA-MTBLK	4.3:1 & 1.3:1	4BB+1TB	40.0	39.2" & 11.8"	34-lbs	48-lbs	870/20, 650/25, 500/30	See Page 55
MK-20IISeA-MTBLK	3.8:1 & 1.3:1	4BB+1TB	45.8	39.4" & 13.2"	37-lbs	55-lbs	870/25, 660/30, 530/40	See Page 55
MK-30IISeA-MTBLK	3.8:1 & 1.3:1	4BB+1TB	50.0	39.4" & 13.2"	37-lbs	55-lbs	850/30, 700/40, 550/50	See Page 55
MK-50IISeA-MTBLK	3.2:1 & 1.0:1	4BB+1TB	61.4	37.8" & 11.9"	60-lbs	85-lbs	1000/30, 650/50, 400/80	See Page 55
MK-50WIISeA-MTBLK	3.2:1 & 1.0:1	4BB+1TB	65.0	37.8" & 11.9"	60-lbs	85-lbs	900/50, 780/60, 560/80	See Page 55
MK-80WIISeA-MTBLK	3.1:1 & 1.2:1	6BB+1TB	116.0	45.7" & 20.5"	70-lbs	100-lbs	1000/80, 850/100, 660/130	See Page 55
MK-130IISeA-MTBLK	2.2:1 & 1.2:1	6BB+1TB	167.0	39.7" & 21.7"	75-lbs	100-lbs	1570/80, 1270/100, 1000/130	See Page 55

*Frame Style: Top Crossbar

MAKAIRA



MAKAIRA SEa LEVER DRAG REELS

- Open spool bearings with TSI-301 oil. Increases freespool 2-1/2 times.
- MK-80WIISeA & MK-130IISeA feature grease-packed spool bearings
- All non-spool bearings feature full grease pack for maximum longevity.
- Features Special Edition Gun Smoke & Black anodizing.
- SE reels feature a yellowfin tuna etched into the sideplate.
- Frames have been machined out for increased clearance between spool & cross bars.
- MK-10/15T feature MK-20 size handle knobs.
- MK-20/30 feature the MK-50 handle arm & knobs
- Lower speed 1.3:1 gear ratio featured in 20/30 sizes.
- Lower speed 1.0:1 gear ratio featured in 50 size.
- Type-II gunmetal anodized frame, sideplates, spool, drag lever & handle
- Backed by a 5-year limited warranty

MAKAIRA SEa SILVER LEVER DRAG REELS

- Open spool bearings with TSI-301 oil. Increases freespool 2-1/2 times.
- MK-80WIISeA & MK-130IISeA feature grease-packed spool bearings
- All non-spool bearings feature full grease pack for maximum longevity.
- Type-II Silver anodized frame, sideplates, spool, drag lever & handle
- Frames have been machined out for increased clearance between spool & cross bars.
- MK-10/15T feature MK-20 size handle knobs.
- MK-20/30 feature the MK-50 handle arm & knobs
- Lower speed 1.3:1 gear ratio featured in 20/30 sizes.
- Lower speed 1.0:1 gear ratio featured in 50 size.
- Backed by a 5-year limited warranty

MODEL	MODEL	GEAR RATIO	BEARINGS	WEIGHT (OZ.)	LINE RETRIEVE	MAX DRAG @ STRIKE	MAX DRAG @ FULL	MONO LINE CAPACITY	BRAIDED LINE RATING
MAKAIRA SEa & SEA SILVER TWO-SPEED LEVER DRAG REELS									
MK-10IISeA	MK-10IISeA-Silver	4.7:1 & 2.1:1	4BB+1TB	26.1	33.5" & 15.0"	27-lbs	34-lbs	460/15, 380/20, 280/25	See Page 55
MK-15IISeA	MK-15IISeA-Silver	4.7:1 & 2.1:1	4BB+1TB	29.0	38.9" & 17.1"	32-lbs	40-lbs	575/20, 425/25, 325/30	See Page 55
MK-16IISeA	MK-16IISeA-Silver	4.3:1 & 1.3:1	4BB+1TB	40.0	39.2" & 11.8"	34-lbs	48-lbs	870/20, 650/25, 500/30	See Page 55
MK-20IISeA	MK-20IISeA-Silver	3.8:1 & 1.7:1	4BB+1TB	45.8	39.4" & 17.5"	37-lbs	55-lbs	870/25, 660/30, 530/40	See Page 55
MK-30IISeA	MK-30IISeA-Silver	3.8:1 & 1.7:1	4BB+1TB	50.0	39.4" & 17.5"	37-lbs	55-lbs	850/30, 700/40, 550/50	See Page 55
MK-50IISeA	MK-50IISeA-Silver	3.2:1 & 1.0:1	4BB+1TB	61.4	37.8" & 11.9"	60-lbs	85-lbs	1000/30, 650/50, 400/80	See Page 55
MK-50WIISeA*	MK-50WIISeA-Silver*	3.2:1 & 1.0:1	4BB+1TB	65.0	37.8" & 11.9"	60-lbs	85-lbs	900/50, 780/60, 560/80	See Page 55
MK-80WIISeA*	MK-80WIISeA-Silver*	3.1:1 & 1.2:1	6BB+1TB	116.0	45.7" & 20.5"	70-lbs	100-lbs	1000/80, 850/100, 660/130	See Page 55
MK-130IISeA*	MK-130IISeA-Silver*	2.2:1 & 1.2:1	6BB+1TB	167.0	39.7" & 21.7"	75-lbs	100-lbs	1570/80, 1270/100, 1000/130	See Page 55

*Frame Style: Top Crossbar



MK-10IISeA

MK15TII-SeA-Silver

MK16II-SeA-Silver

MK20II-SeA-Silver

MK-130WIISeA

MAKAIRA®



MAKAIRA TDC DRAG CAMS

MODEL	DESCRIPTION	MSRP
TDC-8II/10II/15II/15TII	Makaira Tournament Drag Cam	\$24.99
TDC-16II/20II/30II	Makaira Tournament Drag Cam	\$24.99
TDC-50II/50WII	Makaira Tournament Drag Cam	\$29.99
TDC-80WII/130II	Makaira Tournament Drag Cam	\$29.99

*MSRP Subject to Change

Okuma's TDC or "Tournament Drag Cam" is designed with a more gradual ramp in the cam system that is intended for anglers fishing light line & tournament IGFA line classes. The standard cam that is installed in the Makaira reels is engineered to be compatible with braided line & offers aggressive drag ramps in order to output heavy drag ratings. The Makaira reels are engineered to output extreme drag pressure, but this is not required by all anglers. These reels have been designed to offer customization & with the TDC cam system, Okuma is offering anglers a reel that is versatile for a wide range of fishing applications, allowing anglers the ability to achieve a more gradual increase in drag settings.

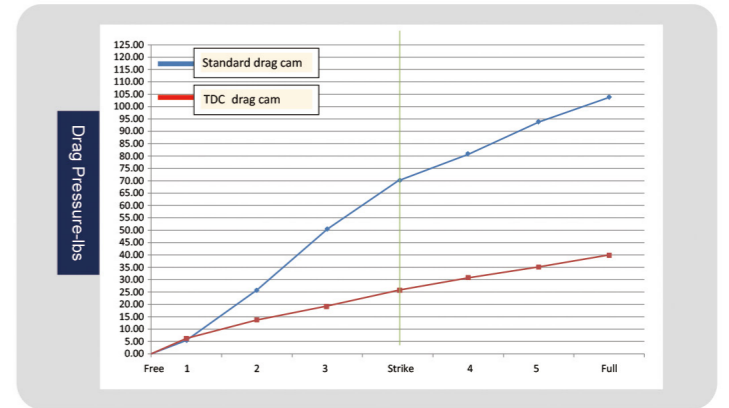
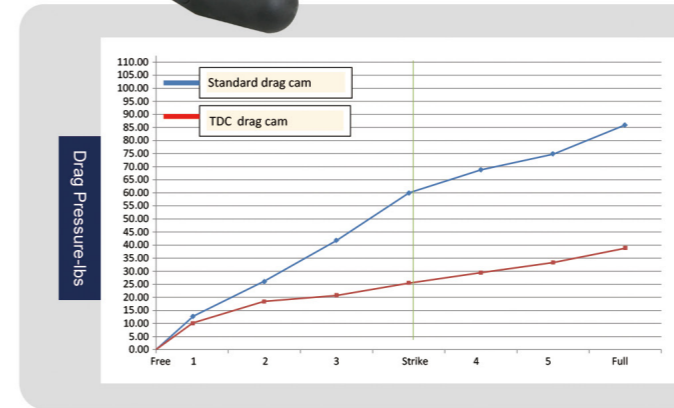
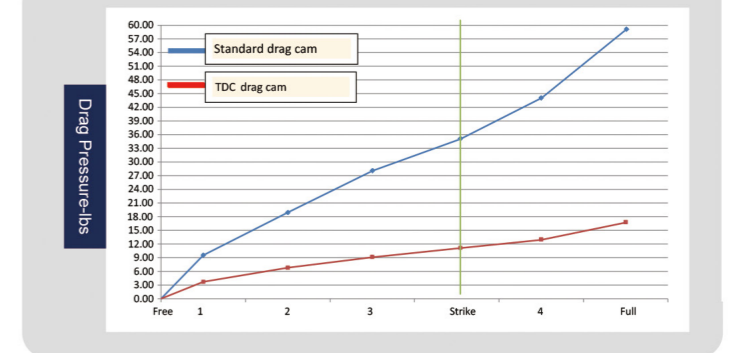
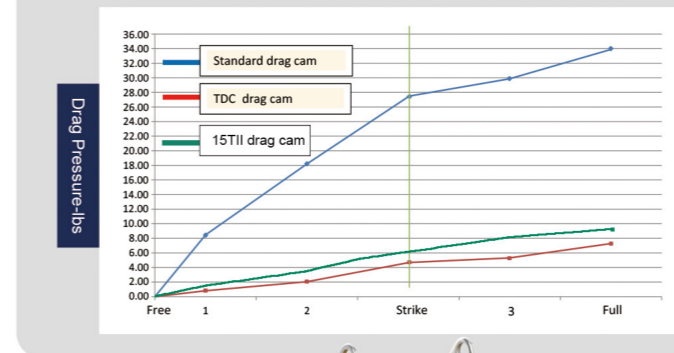

MAKAIRA FEATURES

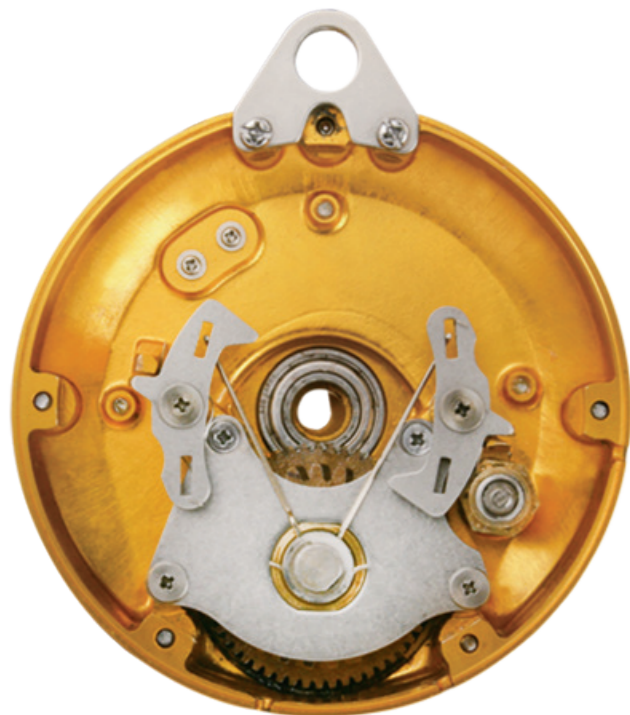

SILENT ANTI-REVERSE:

The Makaira's proprietary anti-reverse system allows for a smoother & quieter feeling. We equate this feeling to that of a Lexus, when compared to other reels in the market. Most reels in the market hide their rough gear quality by the noise & vibration caused by the engagement & clacking of the anti-reverse pawls. The Okuma silent system is unlike any other 2-speed reel in the industry for smoothness. This anti-reverse system is supported by a 12 point double dog anti-reverse pawl system. The Makaira system is very simple in principal but the performance is extremely advanced. As you turn the reel forward the anti-reverse pawls slide open allowing a friction free & quiet retrieve. As soon as the handle is stopped or pulled backwards the anti-reverse pawls are engaged into place by their drive shaft actuated sliding system. The strength of this anti-reverse system does not solely rely on a dog spring like found on most of our competitors reels. The sliding function does not rely heavily on a dog spring system & is mainly controlled by the forward & reverse movement applied to the drive shaft through the movement of the angler turning the handle.



HELICAL CUT GEARING:

Makaira lever drag reels utilize helical cut main & pinion gears. This process allows for improved gear meshing which equates to improved gear smoothness. The angled teeth found in helical cut gears engage more gradually than straight cut or spur gear teeth. This allows helical gears to run smoother & quieter compared to spur gears. Spur gears cause impact stress & noise, because of the hard meshing & can not take as much torque as helical gears because their teeth are receiving impact blows as they mesh together.



GREASE & OIL:

To further enhance the corrosion resistance of Makaira reels, Okuma applies our CRC or Corrosion Resistant Coating process to all internal & external parts for maximum protection. Our CRC process utilizes a coating process of Corrosion X HD formula that actually penetrates & bonds to the aluminum parts for long term protection. The extra steps taken in the assembly of the Makaira allows this reel to be a leader in the fishing tackle industry for long term use & performance. To further enhance the Makaira's function & performance, Okuma applies Cal's Universal drag grease to our carbon fiber drag washers for the smoothest wet drag system. The addition of Cal's drag grease allows for virtually zero start up inertia & smooth performance at all settings. Cal's Universal grease is also used for coating moving parts such as the main & pinion gears for improved performance.

BRAID LINE CAPACITY FOR MAKAIRA REELS

MODEL	BRAID TYPE	BRAIDED LINE LENGTH	TOP SHOT LENGTH
MK-10II	Solid	300-yds of 50-lbs	75 to 100-yds of 20 to 40-lbs
MK-15II	Solid	450-yds of 80-lbs	15-yds top shot
MK-16II	Hollow Core	600-yds of 100-lbs	50 ft. wind on leader
MK-20II	Hollow Core	700-yds of 100-lbs	50 ft. wind on leader
MK-30II	Hollow Core	800-yds of 100-lbs (HC)	80-yds of 80-lbs
MK-50II	Hollow Core	600-yds of 130-lbs (HC)	50 to 80-yds of 80 to 100-lbs
MK-50WII	Hollow Core	800-yds of 130-lbs (HC)	50 to 80-yds of 80 to 100-lbs
MK-80WII	Hollow Core	1000-yds of 80-lbs (HC)	80 to 100-yds of 130-lbs

*MSRP Subject to Change

ALIJOS

ALIJOS 2-SPEED LEVER DRAG REELS

- 17-4 grade stainless steel main and pinion gears
- Carbonite Dual Force Drag system with Cal's drag grease
- Upgraded with Makaira thrust bearing, reduces side load
- 6BB+1TB corrosion resistant stainless steel bearings
- Spool bearings feature TSI-301 oil for unmatched freespool
- Rigid 1-pcs frame and left sideplate construction
- 6061-T6 machined aluminum frame and sideplates
- Cold forged, Type-II anodized, machined aluminum spool
- Silent retrieve system for ultimate cranking smoothness
- 90mm handle arm, increases cranking leverage/power
- Oversized T-Bar handle on all models, for cranking power
- Lug and plug harness system featured on 12 and 16 sizes
- External adjustable cast control system on left sideplate
- CRC: Corrosion Resistant Coating process
- Alijos reels are backed by a 3-year limited warranty



ALIJOS LEVER DRAG HIGH SPEED REELS

- Optimized for fishing consistent light drag settings
- Features TDC drag cams for gradual drag curves
- High speed 6.4:1 gear ratios for quick line recovery
- 17-4 grade stainless steel main & pinion gears
- Carbonite Drag system with Cal's drag grease
- 6-NMB corrosion resistant stainless steel bearings
- Dual anti-reverse system (Mechanical & roller bearing)
- QuickSet anti-reverse bearing allows for zero handle back play
- Rigid 1-pcs frame & left sideplate construction
- 6061-T6 machined aluminum frame & sideplates
- Cold forged, Type-II anodized, machined aluminum spool
- Silent retrieve system for ultimate cranking smoothness
- Lug & plug harness system featured on 12 & 16 sizes
- CRC: Corrosion Resistant Coating process
- Alijos reels are backed by a 3-year limited warranty

	MODEL	GEAR RATIO	BEARINGS	WEIGHT (OZ.)	LINE RETRIEVE	MAX DRAG @ STRIKE	MAX DRAG @ FULL	MONO LINE CAPACITY	BRAIDED LINE RATING
ALIJOS LEVER DRAG REELS - 2 SPEED MODELS									
NEW	AJ-5NII	6.4:1 & 3.8:1	6 BB + 1TB	19.4	42.1" / 24.8"	15-lbs	24-lbs	420/12, 300/15, 250/20	425/40, 350/50
NEW	AJ-5II	6.4:1 & 3.8:1	6 BB + 1TB	19.8	42.1" / 24.8"	15-lbs	24-lbs	620/12, 430/15, 340/20	475/50, 310/65
NEW	AJ-12NSII	6.4:1 & 2.1:1	6 BB + 1TB	27.5	48.4" / 15.7"	27-lbs	34-lbs	350/20, 250/25, 200/30	525/50, 345/65
NEW	AJ-12II	4.7:1 & 2.1:1	6 BB + 1TB	28.6	35.4" / 15.7"	27-lbs	34-lbs	560/20, 420/25, 320/30	460/65, 400/80
NEW	AJ-12SII	6.4:1 & 2.1:1	6 BB + 1TB	28.9	48.4" / 15.7"	27-lbs	34-lbs	560/20, 420/25, 320/30	460/65, 400/80
NEW	AJ-16II	4.3:1 & 1.3:1	6 BB + 1TB	36.3	39.4" / 11.8"	34-lbs	48-lbs	870/20, 650/25, 500/30	870/65, 750/80
ALIJOS LEVER DRAG REELS - HIGH SPEED MODELS									
	AJ-12S SE	6.4:1	6BB + 1RB	25.4	48.4"	5.7-lbs	10-lbs	560/20, 420/25, 320/30	460/65, 400/80, 340/100
	AJ-16S SE	6.4:1	6BB + 1RB	31.4	58.5"	5.7-lbs	10-lbs	870/20, 650/25, 500/30	800/80, 600/100

CAVALLA

CAVALLA LEVER DRAG REELS

- Rigid 1-pcs frame & left sideplate construction
- 6061-T6 Machined aluminum frame & sideplates
- 17-4 grade stainless steel main & pinion gears
- Carbonite drag system with Cal's drag grease
- Cold forged, Type-II anodized, machined aluminum spool
- CRC: Corrosion Resistant Coating process
- 4HPB corrosion resistant stainless steel bearings
- Ergo Grip handle knob with anodized aluminum handle arm
- Silent retrieve system for cranking smoothness
- On/Off bait clicker for all lever drag models
- TB jiggling reel features T-Bar handle knob
- Cavalla lever drag reels are backed by a 3-year limited warranty



CAV-511LX



CAV-1211



CAV-12N11



MODEL	GEAR RATIO	BEARINGS	WEIGHT (OZ.)	LINE RETRIEVE	MAX DRAG	MONO LINE CAPACITY	BRAIDED LINE RATING
CAVALLA SINGLE SPEED JIGGING REEL							
CAV-5NS-TB	6.4:1	4BB	16.4	42.1"	15-lbs / 24-lbs	420/12, 300/15, 250/20	425/40, 350/50
CAVALLA 2-SPEED LEVER DRAG REELS							
CAV-5N11	6.4:1 & 3.8:1	4HPB	16.2	42.1" & 24.8"	15-lbs & 24-lbs	420/12, 300/15, 250/20	425/40, 350/50
CAV-511	6.4:1 & 3.8:1	4HPB	17.1	42.1" & 24.8"	15-lbs & 24-lbs	620/12, 430/15, 340/20	475/50, 310/65
CAV-12N11	4.7:1 & 2.1:1	4HPB	23.8	35.4" & 15.7"	27-lbs & 34-lbs	350/20, 250/25, 200/30	525/50, 345/65
CAV-1211	4.7:1 & 2.1:1	4HPB	24.9	35.4" & 15.7"	27-lbs & 34-lbs	560/20, 420/25, 320/30	460/65, 400/80
CAV-511LX*	6.4:1 & 3.8:1	4HPB	17.1	42.1" & 24.8"	15-lbs & 24-lbs	620/12, 430/15, 340/20	475/50, 310/65
CAV-1211LX*	4.7:1 & 2.1:1	4HPB	24.9	35.4" & 15.7"	27-lbs & 34-lbs	560/20, 420/25, 320/30	460/65, 400/80

*Left Handle Retrieve

SOLTERRA SLX "B"

SOLTERRA SLX "B" LEVER DRAG REELS

- Stainless steel main gears, pinion gears & shafts
- Single speed, High-speed & Two-speed models
- Durable corrosion-resistant frame & sideplates
- Stainless steel reinforcing sideplate rings
- Forged aluminum spool with line indicator rings
- Carbonite drag system with Cal's universal drag grease
- 2 thrust bearings reduce handle turning force by over 50%.
- 5BB+2TB stainless steel shielded bearings 20-50W models
- 5BB+2TB+RB stainless steel shielded bearings 10/15 models
- Double dog, silent anti-reverse on all models
- Dual anti-reverse system on all 10/15 sizes
- Ratcheting drag lever for precise drag setting
- Stainless Steel Body Armor reduces frame flex 20-50W models
- T-Bar handle design on 50W-size
- Ergo Grip comfort handle on all 10 through 30 sizes
- Low profile On/Off clicker with stainless steel wishbone
- Wide-mouth levelwind: Stainless steel with Ti coating "L" models
- High Speed 6.2:1 gear ratios on SLX-10CS & SLX-15CS
- Open top frame design on SLX-10CS & SLX-15CS
- Solterra lever drag reels are backed by a 1-year limited warranty



SLX-20b



MODEL	GEAR RATIO	BEARINGS	WEIGHT (OZ.)	LINE RETRIEVE	MAX DRAG	MONO LINE CAPACITY	BRAIDED LINE RATING
SOLTERRA SLX "B" LEVER DRAG REELS							
NEW SLX-10CSb*	6.0:1	5BB+2TB+1RB	23.3	42"	15-lbs / 22-lbs	460/15, 380/20, 280/25	550/50, 380/65
NEW SLX-15CSb*	6.0:1	5BB+2TB+1RB	24.6	42"	15-lbs / 22-lbs	550/20, 410/25, 310/30	560/65, 510/80
NEW SLX-20b	3.5:1	5-BB+2TB	38.8	32"	26-lbs / 33-lbs	620/25, 480/30, 400/40	850/65, 770/80
NEW SLX-30b	3.5:1	5-BB+2TB	40	32"	26-lbs / 33-lbs	640/30, 540/40, 400/50	1050/80, 880/100
NEW SLX-50Wb	3.1:1	5-BB+2TB	52.5	32"	32-lbs / 40-lbs	710/50, 600/60, 420/80	1825/80, 1530/100
SOLTERRA SLX "B" 2 SPEED LEVER DRAG REELS							
NEW SLX-2011b†	3.8:1 / 1.7:1	5-BB+2TB	39.2	35" & 15"	26-lbs / 33-lbs	620/25, 480/30, 400/40	850/65, 770/80
NEW SLX-3011b†	3.8:1 / 1.7:1	5-BB+2TB	40.5	35" & 15"	26-lbs / 33-lbs	640/30, 540/40, 400/50	1050/80, 880/100
NEW SLX-5011b†	3.1:1 / 1.3:1	5-BB+2TB	53.3	32" & 13"	32-lbs / 40-lbs	710/50, 600/60, 420/80	1825/80, 1530/100
SOLTERRA SLX "B" SINGLE SPEED LEVELWIND REELS							
NEW SLX-10Lb‡	4.2:1	5BB+2TB+1RB	24.4	29"	15-lbs / 22-lbs	460/15, 380/20, 280/25	550/50, 380/65
NEW SLX-15Lb‡	4.2:1	5BB+2TB+1RB	25.9	29"	15-lbs / 22-lbs	550/20, 410/25, 310/30	560/65, 510/80
NEW SLX-20Lb	3.5:1	5-BB+2TB	40.7	32"	26-lbs / 33-lbs	620/25, 480/30, 400/40	850/65, 770/80

*Features open top †Features frame with top cross bar & harness lugs ‡Features frame with top cross bar



Nothing inspires the soul like a finely-crafted fishing rod. Upon picking it up, flexing the action & feeling the balance, an angler can immediately visualize the experience- working a bait, feeling the strike, the deep flex under the load of a heavy fish. While the needs of each fishery can be dramatically different, the goal is universally the same: to actively connect with nature as a participant instead of a spectator. With many hundreds of unique rod models covering unique territories, species & techniques, our development process is highly collaborative. We work with the finest anglers in a given discipline to define the performance attributes. Then we bring them to life within our cutting-edge manufacturing facility.

LIGHTWEIGHT STRENGTH BUILT FOR ANY CHALLENGE

Okuma's Ultimate Matrix Reinforcement (UMR) technology maximizes rod strength while minimizing weight, so you can rise to meet any challenge.

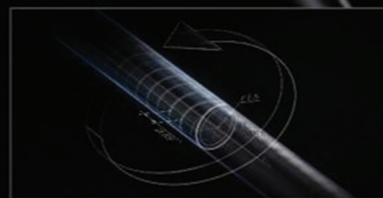

**ULTIMATE
MATRIX
REINFORCEMENT**



A Rear split grip with SeaGuide carbon trigger reel seat & carbon screw down

B Rear split grip with SeaGuide carbon spinning reel seat & carbon screw down



Psycho Stick RODS

PSYCHO STICK RODS

- Light & responsive 46-ton, low resin carbon rod blanks
- UMR: Ultimate Matrix Reinforcement technology
- Fuji KW-concept angled guide frames help reduce tangles
- Fuji Sic guide inserts with deep pressed frames
- SeaGuide injected carbon reel seat & rear grip
- Double locking screw down carbon hood design
- Psycho Stick are backed by a limited lifetime warranty



MODEL	PWR	TAPER	LENGTH (FT)	LINE WT (LBS)	LURE WT. (OZ)	FOREGRIP LENGTH	REARGRIP LENGTH	SECTIONS	GUIDES	WEIGHT (OZ)	HANDLE
PSYCHO STICK RODS											
PSY-S-721ML	ML	F	7'2"	6-12	1/8-1/2	1-1/4"	9-1/2"	1-pcs	7 + Tip	4.2	B
PSY-S-721M	M	F	7'2"	8-17	1/8-5/8	1-1/4"	9-1/2"	1-pcs	7 + Tip	4.3	B
PSY-C-721M	M	F	7'2"	8-17	1/8-5/8	1-1/4"	8-3/4"	1-pcs	9 + Tip	4.3	A
PSY-C-721MH	MH	F	7'2"	10-20	1/4-3/4	1-1/4"	10-1/2"	1-pcs	9 + Tip	4.6	A
PSY-C-721H	H	F	7'2"	12-25	1/4-1	1-1/4"	10-1/2"	1-pcs	9 + Tip	4.9	A
PSY-C-751MH	MH	F	7'5"	10-20	1/4-3/4	1-1/4"	10-1/2"	1-pcs	10 + Tip	4.9	A
PSY-C-751H	H	F	7'5"	12-25	1/4-1	1-1/4"	10-1/2"	1-pcs	10 + Tip	5.3	A

C = Casting Model S = Spinning Model

Guide Select CRANKING RODS



A Rear cork split grip with Fuji ACS reel seat & carbon screw down

B Full cork rear grip with Fuji ACS reel seat & carbon screw down

GUIDE SELECT CRANKING RODS

- Light & responsive 24-ton, low resin carbon rod blanks
- Specifically developed to load & cast crank baits
- UFR: Ultimate Flex Reinforced rod tip technology
- Fuji KW-concept angled guide frames
- Fuji Aconite guide inserts with deep pressed frames
- Fuji ACS trigger reel seats w/ screw down carbon hood
- Tapered cork full or split grip configurations
- SeaGuide Stainless steel, double legged Trapezoid hook keeper
- Backed by a limited lifetime warranty

MODEL	PWR	TAPER	LENGTH (FT)	LINE WT (LBS)	LURE WT. (OZ)	FOREGRIP LENGTH	REARGRIP LENGTH	SECTIONS	GUIDES	WEIGHT (OZ)	HANDLE
GUIDE SELECT CRANKING RODS											
GS-C-691M	M	MF	6'9"	8-17	1/8-3/4	0"	10"	1-pcs	8+Tip	4.8	A
GS-C-701M	M	MF	7'0"	8-17	3/16-3/4	0"	10"	1-pcs	8+Tip	5.1	A
GS-C-751M	M	MF	7'5"	8-17	3/16-1	0"	11-1/4"	1-pcs	9+Tip	4.6	A
GS-C-751MH	MH	MF	7'5"	10-20	1/4-2	0"	11-1/4"	1-pcs	9+Tip	4.8	A
GS-C-7101M	M	MF	7'10"	8-17	3/16-1	0"	12-1/4"	1-pcs	10+Tip	4.9	A
GS-C-7101MH	MH	MF	7'10"	10-20	1/4-2	0"	12-1/4"	1-pcs	10+Tip	5.0	A
GS-C-7101M-FG	M	MF	7'10"	8-17	3/16-1	0"	12-1/4"	1-pcs	10+Tip	5.1	B
GS-C-7101MH-FG	MH	MF	7'10"	10-20	1/4-2	0"	12-1/4"	1-pcs	10+Tip	5.1	B

C = Casting Model

TOURNAMENT CONCEPT RODS

- Specially designed technique specific bass rod series
- Responsive & durable 24-ton carbon rod blanks
- Fuji K-Concept guide frames help reduce wind knots
- Fuji K-Concept frames for max compatibility for braided line
- Fuji Faz-Light guide inserts offer premium performance
- Customized C-40X carbon fiber skeleton reel seat
- Contoured EVA/compressed cork fore & rear split grips
- Screw down foregrip eliminates contact with reel seat threads
- Backed by a Limited Lifetime warranty

MODEL	PWR	TAPER	LENGTH (FT)	LINE WT (LBS)	LURE WT. (OZ)	FOREGRIP LENGTH	REARGRIP LENGTH	SECTIONS	GUIDES	WEIGHT (OZ)	HANDLE
TOURNAMENT CONCEPT RODS											
TCS-S-691Ma+	M	MF	6'9"	8-15	1/4-5/8	1-1/4"	9"	1-pcs	7+Tip	4.0	B
TCS-S-701MLa	ML	MF/F	7'0"	4-10	1/8-1/2	1-1/4"	9"	1-pcs	7+Tip	4.2	B
TCS-S-701Ma+	M	MF	7'0"	8-12	1/8-1/2	1-1/4"	9"	1-pcs	7+Tip	4.6	B
TCS-S-721MLa	ML	MF/F	7'2"	4-10	1/8-1/2	1-1/4"	9"	1-pcs	7+Tip	4.5	B
TCS-C-691MHa	MH	MF	6'9"	10-17	1/8-3/4	1-1/4"	9-1/2"	1-pcs	9+Tip	3.8	A
TCS-C-701Ma+	M	M/MF	7'0"	8-15	3/8-3/4	1-1/4"	9-1/2"	1-pcs	9+Tip	4.0	A
TCS-C-701MHa	MH	MF	7'0"	8-20	3/16-3/4	1-1/4"	9-1/2"	1-pcs	9+Tip	4.4	A
TCS-C-701Ha	H	MF	7'0"	12-20	3/16-1	1-1/4"	9-1/2"	1-pcs	9+Tip	4.6	A
TCS-C-731Ha	H	F	7'3"	17-65	1/4-2	1-1/4"	9-1/2"	1-pcs	9+Tip	4.8	A
TCS-C-761Ha	H	MF/F	7'6"	14-30	1/4-1-1/2	1-1/4"	10-3/4"	1-pcs	11+Tip	5.4	A
TCS-C-7111MHa	MH	M/MF	7'11"	10-20	1/4-1	1-1/4"	12-1/2"	1-pcs	11+Tip	5.0	A
TCS-C-7111Ha	H	F	7'11"	15-65	1/4-2	1-1/4"	12-1/2"	1-pcs	11+Tip	5.5	A
TCS-C-7111XH	XH	F	7'11"	20-80	1/4-2	1-1/4"	12-1/2"	1-pcs	11+Tip	5.7	A

C = Casting Model S = Spinning Model

SERRANO RODS

- Specially designed technique specific bass rod series
- Responsive & durable 24-ton carbon rod blanks
- UFR: Ultimate Flex Reinforced rod tip technology
- Fuji K-Concept guide frames help reduce wind notes
- Fuji K-Concept frames offer max compatibility for braided line
- Fuji Faz-Light guide inserts offer premium performance
- 3K woven carbon butt section improves hoop strength
- Winn grip & EVA rear split rear grip handle design
- Backed by a Limited Lifetime warranty

MODEL	PWR	TAPER	LENGTH (FT)	LINE WT (LBS)	LURE WT. (OZ)	FOREGRIP LENGTH	REARGRIP LENGTH	SECTIONS	GUIDES	WEIGHT (OZ)	HANDLE
SERRANO RODS											
SRN-S-721M	M	XF	7'2"	8-17	1/8-5/8	0"	10-5/8"	1-pcs	7+Tip	4.8	B
SRN-S-721MH	MH	XF	7'2"	10-20	1/4-3/4	0"	10-5/8"	1-pcs	7+Tip	5.1	B
SRN-S-741ML	ML	XF	7'4"	6-12	1/8-1/2	0"	11"	1-pcs	7+Tip	4.6	B
SRN-C-6101M	M	XF	6'10"	8-17	1/8-5/8	0"	10-1/4"	1-pcs	8+Tip	4.4	A
SRN-C-6101MH	MH	XF	6'10"	10-20	1/4-3/4	0"	10-1/4"	1-pcs	8+Tip	4.8	A
SRN-C-731M	M	XF	7'3"	8-17	1/8-5/8	0"	10-5/8"	1-pcs	9+Tip	4.9	A
SRN-C-731MH	MH	XF	7'3"	10-20	1/4-3/4	0"	10-5/8"	1-pcs	9+Tip	5.0	A
SRN-C-731H	H	XF	7'3"	12-25	1/4-1	0"	10-5/8"	1-pcs	9+Tip	5.1	A
SRN-C-761XH	XH	XF	7'6"	15-30	1/4-1-1/2	0"	11"	1-pcs	10+Tip	5.1	A

C = Casting Model S = Spinning Model

CERROS RODS

- Specially designed technique specific bass rod series
- Responsive & durable 24-ton carbon blank construction
- UFR: Ultimate Flex Reinforced rod tip technology
- Sea Guide XO 316-SS angled guide frames reduce line twists
- Zirconium line guide insert for reduced line abrasion
- 3K woven carbon butt section improves hoop strength
- Split rear grip handle design with contoured EVA
- Cerros rods are backed by a 1-year limited warranty

MODEL	PWR	TAPER	LENGTH (FT)	LINE WT (LBS)	LURE WT. (OZ)	FOREGRIP LENGTH	REARGRIP LENGTH	SECTIONS	GUIDES	WEIGHT (OZ)	HANDLE
CERROS RODS											
CRS-S-701ML	ML	XF	7'0"	6-12 lb	1/8-1/2 oz	0"	10-1/2"	1-pcs	7+Tip	3.5	B
CRS-S-701M	M	XF	7'0"	8-17 lb	1/8-5/8 oz	0"	10-1/2"	1-pcs	7+Tip	4.2	B
CRS-S-701MH	MH	XF	7'0"	10-20 lb	1/4-3/4 oz	0"	10-1/2"	1-pcs	7+Tip	4.7	B
CRS-S-702M	M	XF	7'0"	8-17 lbs	1/8-5/8 oz	0"	10-1/2"	2-pcs	7+Tip	4.2	B
CRS-S-702MH	MH	XF	7'0"	10-20 lbs	1/4-3/4 oz	0"	10-1/2"	2-pcs	7+Tip	4.8	B
CRS-C-701M	M	XF	7'0"	8-17 lb	1/8-5/8 oz	0"	11-1/4"	1-pcs	9+Tip	4.0	A
CRS-C-701MH	MH	XF	7'0"	10-20 lb	1/4-3/4 oz	0"	11-1/4"	1-pcs	9+Tip	4.4	A
CRS-C-731MH	MH	XF	7'3"	10-20 lb	1/4-3/4 oz	0"	11-3/4"	1-pcs	9+Tip	4.2	A
CRS-C-731H	H	XF	7'3"	12-25 lb	1/4-1 oz	0"	11-3/4"	1-pcs	9+Tip	4.7	A
CRS-C-741XH	XH	XF	7'4"	15-30 lb	1/4-1-1/2 oz	0"	12"	1-pcs	9+Tip	5.1	A
CRS-C-761MH	MH	XF	7'6"	10-20 lb	1/4-3/4 oz	0"	12"	1-pcs	9+Tip	4.2	A
CRS-C-761H	H	XF	7'6"	12-25 lb	1/4-1 oz	0"	12"	1-pcs	9+Tip	4.6	A
CRS-C-7111MH	MH	XF	7'11"	12-25 lb	1/4-2 oz	0"	13-3/4"	1-pcs	10+Tip	4.8	C
CRS-C-7111XH	XH	XF	7'11"	15-30 lb	3/8-2 oz	0"	13-3/4"	1-pcs	10+Tip	5.9	C
CRS-C-7111MGXH	MG-XH	XF	7'11"	20-40 lb	4-10 oz	0"	13-3/4"	1-pcs	10+Tip	8.6	C

C = Casting Model S = Spinning Model

SERRANO



A Split Winn & EVA rear grip with C-40X skeleton trigger reel seat

B Split Winn & EVA rear grip with C-40X skeleton reel seat

CERROS



A Split EVA rear grip with trigger skeleton reel seat

B Split EVA rear grip with skeleton reel seat

C Split EVA rear grip with full trigger reel seat

Reflexions

"B" RODS

REFLEXIONS "B" RODS

- Light and responsive 24-ton carbon rod blanks
- UFR: Ultimate Flex Reinforced rod tip technology
- Sea Guide stainless steel Deep Pressed guide frames
- Zirconium inserts offer compatibility for braid and mono
- Split rear cork grip helps reduce weight and improve balance
- Precision placed stainless steel hook keeper on all models
- Reflexions Rods are backed by a 1-year limited warranty

MODEL	PWR	TAPER	LENGTH (FT)	LINE WT (LBS)	LURE WT. (OZ)	FOREGRIP LENGTH	REARGRIP LENGTH	SECTIONS	GUIDES	WEIGHT (OZ)	HANDLE
REFLEXIONS "B" RODS											
RX-C-722Mb	M	MF/F	7'2"	8-17 lbs	1/4 - 5/8 oz	1"	10"	2-pcs	8+Tip	5.1	B
RX-C-722MHb	MH	F	7'2"	12-25 lbs	3/8 - 1-1/4 oz	1"	10"	2-pcs	8+Tip	5.8	B
Rx-C-691MHb	M	F	6'9"	8-17 lbs	1/4 - 5/8 oz	1"	10"	1-pcs	8+Tip	4.6	B
Rx-C-731Mb	M	F	7'3"	8-17 lbs	1/4 - 5/8 oz	1"	10"	1-pcs	8+Tip	4.8	B
Rx-C-731MHb	MH	F	7'3"	12-25 lbs	3/8 - 1-1/4 oz	1"	10"	1-pcs	8+Tip	5.0	B
RX-S-562MHb	MH	F	5'6"	8-17 lbs	1/4 - 1 oz	1"	8-3/4"	2-pcs	5+Tip	4.2	A
Rx-S-682Mb	M	F	6'8"	8-17 lbs	1/4 - 5/8 oz	1"	9-1/2"	2-pcs	6+Tip	4.3	A
RX-S-682MHb	MH	F	6'8"	10-20 lbs	1/4 - 1 oz	1"	9-1/2"	2-pcs	6+Tip	4.6	A
RX-S-722Mb	M	MF/F	7'2"	8-17 lbs	1/4 - 5/8 oz	1"	9-1/2"	2-pcs	6+Tip	5.1	A
RX-S-722MHb	MH	F	7'2"	12-25 lbs	3/8 - 1-1/4 oz	1"	9-1/2"	2-pcs	6+Tip	5.1	A
Rx-S-661MHb	ML	F	6'6"	10-20 lbs	1/4 - 1 oz	1"	9-1/2"	1-pcs	6+Tip	4.2	A
Rx-S-691MLb	MH	MF/F	6'9"	6-12 lbs	1/8 - 1/2 oz	1"	9-1/2"	1-pcs	6+Tip	4.0	A
Rx-S-691Mb	M	F	6'9"	8-17 lbs	1/4 - 5/8 oz	1"	9-1/2"	1-pcs	6+Tip	4.3	A
RX-S-721MLb	ML	MF/F	7'2"	6-15 lbs	1/8 - 5/8 oz	1"	9-1/2"	1-pcs	6+Tip	4.2	A
RX-S-721Mb	M	F	7'2"	8-17 lbs	1/4 - 5/8 oz	1"	9-1/2"	1-pcs	6+Tip	4.6	A
RX-S-721MHb	MH	F	7'2"	12-25 lbs	3/8 - 1-1/4 oz	1"	9-1/2"	1-pcs	6+Tip	4.8	A
RX-S-761MLb	ML	MF/F	7'6"	6-12 lbs	1/8 - 5/8 oz	1"	10-3/4"	1-pcs	8+Tip	4.1	A
Rx-S-761Mb	M	MF/F	7'6"	8-14 lbs	1/8 - 5/8 oz	1"	10-3/4"	1-pcs	8+Tip	4.3	A

C = Casting Model S = Spinning Model

UFR OXX



A Split cork rear grip with pipe reel seat

B Split cork rear grip with trigger reel seat

AVENGER CARP RODS

- Rod blanks specifically designed for carp fishing
- Fast and responsive 24-ton carbon rod blanks
- 2-pcs blanks with tip over butt ferrule connection
- Minimal split grip design with tapered EVA
- Stainless steel guide frames for maximum durability
- Avenger Carp rods are backed by a 1-year limited warranty

	MODEL	PWR	TAPER	LENGTH (FT)	LINE WT (LBS)	LURE WT. (OZ)	FOREGRIP LENGTH	REARGRIP LENGTH	SECTIONS	GUIDES	WEIGHT (OZ)	HANDLE
	AVENGER CARP RODS											
NEW	AV-CA-1002MH	MH	MF	10'0"	3-lbs	—	3/4"	19-1/2"	2-pcs	5+Tip	9.5	A
NEW	AV-CA-1202MH	MH	MF	12'0"	3-lbs	—	3/4"	22"	2-pcs	5+Tip	11.1	A

C = Casting Model

GUIDE SELECT "A" SWIMBAIT RODS

- Light and responsive 30/40-Ton, low resin carbon rod blanks
- UFR: Ultimate Flex Reinforced rod tip technology
- Evo Graph: 1K woven carbon reinforced blank
- Fuji Alconite guide inserts. Compatible for braided line
- All rods are 7'11" in length for maximum casting distance
- Designed with longitudinal fiber tip for maximum strength/durability
- Fuji K-concept guide frames for maximum compatibility with braided line
- EVA rear split butt handle design for reduced weight & improved balance
- Fuji reel seats for maximum performance
- Stainless steel hook keepers on all models
- Guide Select rods are backed by a 1-year limited warranty

	MODEL	PWR	TAPER	LENGTH (FT)	LINE WT (LBS)	LURE WT. (OZ)	FOREGRIP LENGTH	REARGRIP LENGTH	SECTIONS	GUIDES	WEIGHT (OZ)	HANDLE
	GUIDE SELECT "A" SWIMBAIT RODS											
	GS-C-7111Ha	H	MF	7'11"	15-30 lbs	1-6 oz	3-1/2"	14-1/4"	1-pc	10+Tip	7.6	A
	GS-C-7111XHa	XH	F	7'11"	15-40 lbs	2-10 oz	3-1/2"	14-1/4"	1-pc	10+Tip	8.8	A
	GS-C-7111XXHa	XXH	F	7'11"	20-40 lbs	5-14 oz	3-1/2"	14-1/4"	1-pc	10+Tip	9.2	A

C = Casting Model

AVENGER

CARP RODS

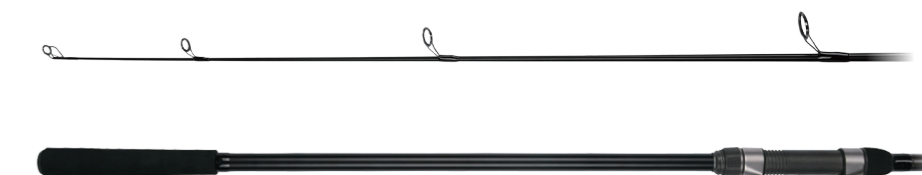

A EVA rear split grip with pipe reel seat

Guide Select



A Split EVA/cork rear grip with Fuji trigger reel seat

Psycho Stick

MUSKY RODS



A Full tapered cork rear grip with Fuji trigger reel seat

PSYCHO STICK MUSKY RODS

- Light and responsive 30/40-Ton, low resin carbon rod blanks
- UMR: Ultimate Matrix Reinforcement technology
- Fuji KW-concept angled guide frames help reduce tangles
- Fuji Alconite guide inserts with deep pressed frames
- Specialized Fuji SiC tip guide for maximum wear resistance
- Fuji oversized trigger reel seat for maximum comfort
- Full tapered cork fore and rear grip design
- Psycho Stick are backed by a limited lifetime warranty

MODEL	PWR	TAPER	LENGTH (FT)	LINE WT (LBS)	LURE WT. (OZ)	FOREGRIP LENGTH	REARGRIP LENGTH	SECTIONS	GUIDES	WEIGHT (OZ)	HANDLE
PSYCHO STICK MUSKY RODS											
PSY-C-861H-T-FG	H	MF/F	8'6"	50-100 lbs	2-10 oz	4-3/4"	16-1/4"	1-Tele	10+ Tip	10.1	A
PSY-C-861XH-T-FG	XH	MF/F	8'6"	65-100 lbs	4-16 oz	4-3/4"	16-1/4"	1-Tele	10+ Tip	11.4	A
PSY-C-861XXH-T-FG	XXH	MF/F	8'6"	65-130 lbs	4-20 oz	4-3/4"	16-1/4"	1-Tele	10+ Tip	12.6	A
PSY-C-961H-T-FG	H	MF/F	9'6"	50-100 lbs	2-10 oz	4-3/4"	17-1/2"	1-Tele	10+ Tip	11.4	A
PSY-C-961XH-T-FG	XH	MF/F	9'6"	65-100 lbs	4-16 oz	4-3/4"	17-1/2"	1-Tele	10+ Tip	12.6	A
PSY-C-961XXH-T-FG	XXH	MF/F	9'6"	65-130 lbs	4-20 oz	4-3/4"	17-1/2"	1-Tele	10+ Tip	14.2	A

C = Casting Model

EVX

MUSKY Rods



A Split cork rear grip and trigger reel seat



B Full cork rear grip and trigger reel seat

EVX MUSKY RODS

- Responsive & durable 24-ton carbon rod blanks
- UFR: Ultimate Flex Reinforcement rod tip technology
- UFR technology increases rod tip lifting power by 3 times
- Double foot deep press stainless steel Sea Guide frames
- Specialized RS tip insert for unmatched hardness & durability
- Premium cork Split grip configuration on standard models
- Full cork rear grip configuration on "FG" models
- All models feature a contoured 5-1/2" cork foregrip
- Telescopic "T": Easy storage & longer casting distance
- Stainless steel hook keepers to accommodate large baits.
- EVx "b" Musky rods backed by a limited lifetime warranty

MODEL	PWR	TAPER	LENGTH (FT)	LINE WT (LBS)	LURE WT. (OZ)	FOREGRIP LENGTH	REARGRIP LENGTH	SECTIONS	GUIDES	WEIGHT (OZ)	HANDLE
EVX MUSKY RODS											
EVx-C-761H-Tb	H	MF	7'6"	30-65 lbs	1-8 oz	5-1/2"	14"	1-Tele	8+ Tip	7.9	A
EVx-C-761XH-Tb	XH	MF	7'6"	50-100 lbs	4-12 oz	5-1/2"	14"	1-Tele	8+ Tip	8.9	A
EVx-C-861H-Tb	H	MF	8'6"	30-65 lbs	2-8 oz	5-1/2"	16"	1-Tele	10+ Tip	10.5	A
EVx-C-861XH-Tb	XH	MF/F	8'6"	50-100 lbs	4-12 oz	5-1/2"	16"	1-Tele	10+ Tip	11.8	A
EVx-C-861XXH-Tb	XXH	F	8'6"	65-130 lbs	4-16 oz	5-1/2"	16"	1-Tele	9+ Tip	13.4	A
EVx-C-931H-Tb	H	MF/F	9'3"	50-100 lbs	2-10 oz	5-1/2"	16"	1-Tele	10+ Tip	12.3	A
EVx-C-931XH-Tb	XH	MF/F	9'3"	65-100 lbs	4-16	5-1/2"	16"	1-Tele	10+ Tip	13.7	A
EVx-C-861XHT-FGb	XH	MF/F	8'6"	50-100 lbs	4-12 oz	5-1/2"	16"	1-Tele	10+ Tip	12.6	B
EVx-C-931XHT-FGb	XH	MF/F	9'3"	65-100 lbs	4-16	5-1/2"	16"	1-Tele	10+ Tip	14.5	B

C = Casting Model



A Full tapered cork butt with spinning reel seat

B Full tapered cork butt with trigger reel seat



Snakehead Junky

Snakehead Junky Rods

- Specifically designed for targeting Snakehead
- Light and responsive 24-ton carbon rod blanks
- UFR: Ultimate Flex Reinforced rod tip technology
- Sea Guide XO/XQ 316-SS angled guide frames reduce line twists
- Zirconium inserts offer compatibility for both braid and mono
- Tapered cork fore and rear grip with rubber cork
- Precision placed stainless steel hook keeper on all models
- Snakehead Rods are backed by a 1-year limited warranty

MODEL	PWR	TAPER	LENGTH (FT)	LINE WT (LBS)	LURE WT. (OZ)	FOREGRIP LENGTH	REARGRIP LENGTH	SECTIONS	GUIDES	WEIGHT (OZ)	HANDLE
Snakehead Junky Rods											
SJ-S-661MH	MH	MF	6'6"	10-20 lbs	1/4-3/4 oz	1"	7-1/2"	1-pcs	6+ Tip	5.6	A
SJ-S-701MH	MH	MF	7'0"	10-20 lbs	1/4-3/4 oz	2"	11"	1-pcs	7+ Tip	5.4	A
SJ-C-701MH	MH	MF	7'0"	12-25 lbs	1/4-1 oz	2"	11-3/4"	1-pcs	9+ Tip	5.4	B
SJ-C-731MH	MH	MF	7'3"	10-20 lbs	1/4-3/4 oz	2"	11-1/2"	1-pcs	9+ Tip	5.4	B
SJ-C-731H	H	MF	7'3"	10-20 lbs	1/4-3/4 oz	2"	11-1/2"	1-pcs	9+ Tip	5.8	B

C = Casting Model S = Spinning Model



DEAD EYE *Custom*



A Split TPE/Cork rear split grip combo with ALPS RPD reel seat

DEAD EYE *Pro*



A Split cork rear grip with pipe reel seat



B Full cork fore & rear grip with pipe reel seat



C Full cork fore & rear grip with trigger reel seat



D 3K woven carbon fore & rear grip with trigger reel seat

DEAD EYE CUSTOM RODS

- Custom technique specific Walleye Jigging rods
- 30/40-ton carbon, ultra-sensitive & responsive blanks
- SCT blank technology improves strength & durability
- SCT is a dual helix wrap with over 6000 strands of carbon thread
- Sea Guide XO 316-SS angled guide frames
- Specialized stainless steel tip
- Features a custom cork & EVA rear split grip configuration
- Premium ALPS RPD reel seat with aluminum thread nut
- Specialized stainless steel hook keeper on all models
- Backed by a limited lifetime warranty

MODEL	PWR	TAPER	LENGTH (FT)	LINE WT (LBS)	LURE WT. (OZ)	FOREGRIP LENGTH	REARGRIP LENGTH	SECTIONS	GUIDES	WEIGHT (OZ)	HANDLE
DEAD EYE CUSTOM RODS											
DCS-S-601MXF	M	XF	6'0"	8-12 lbs	1/4-5/8oz	2"	7"	1-pcs	7 + Tip	4.2	A
DCS-S-601MHXF	MH	XF	6'0"	8-15 lbs	3/8-1oz	2"	7"	1-pcs	7 + Tip	4.6	A
DCS-S-681MLXF	ML	XF	6'8"	6-10 lbs	3/16-3/8oz	2"	8"	1-pcs	8 + Tip	4.2	A
DCS-S-681MXF	M	XF	6'8"	8-12 lbs	1/4-5/8oz	2"	8"	1-pcs	8 + Tip	4.4	A
DCS-S-741MLXF	ML	XF	7'4"	6-10 lbs	3/16-3/8oz	2"	9"	1-pcs	9 + Tip	4.3	A
DCS-S-741MXF	M	XF	7'4"	8-12 lbs	1/4-5/8oz	2"	9"	1-pcs	9 + Tip	4.8	A

S = Spinning Model

DEAD EYE PRO RODS

- Technique specific Walleye rod design
- Designed with ultra-responsive 24-ton carbon blanks
- UFR: Ultimate Flex Reinforced rod tip technology
- Sea Guide XO 316-SS angled guide frames for reduced line twists
- Zirconium line guide insert for reduced line abrasion
- Specialized stainless steel tip, prevents inserts from popping out
- 3K woven carbon fiber fore & rear grips for maximum durability
- Backed by a 1-year limited warranty

MODEL	PWR	TAPER	LENGTH (FT)	LINE WT (LBS)	LURE WT. (OZ)	FOREGRIP LENGTH	REARGRIP LENGTH	SECTIONS	GUIDES	WEIGHT (OZ)	HANDLE
DEAD EYE PRO RODS											
DEP-S-602MHFT	MH	F	6'0"	6-12 lbs	1/8-5/8 oz	1"	9"	2-pcs	6 + Tip	5.1	A
DEP-S-662MFT	M	F	6'6"	8-15 lbs	3/8-1oz	1"	9"	2-pcs	6 + Tip	5.6	A
DEP-S-601MHFT	MH	F	6'0"	8-15 lbs	3/8-1oz	2"	9"	1-pcs	6 + Tip	5.3	A
DEP-S-661MLFT	ML	F	6'6"	4-10 lbs	1/16-3/8 oz	2"	9"	1-pcs	6 + Tip	3.4	A
DEP-S-661MFT	M	F	6'6"	6-12 lbs	1/8-5/8 oz	2"	9"	1-pcs	6 + Tip	3.6	A
DEP-S-701MLFT	ML	F	7'0"	4-10 lbs	1/16-3/8 oz	2"	9"	1-pcs	7 + Tip	3.8	A
DEP-S-661MLFT-FG	ML	F	6'6"	4-10 lbs	1/16-3/8 oz	2"	9"	1-pcs	6 + Tip	3.9	B
DEP-S-701MLFT-FG	ML	F	7'0"	4-10 lbs	1/16-3/8 oz	2"	9"	1-pcs	7 + Tip	4.2	B
DEP-S-761MFT	M	F	7'6"	6-12 lbs	1/8-5/8 oz	2"	9"	1-pcs	8 + Tip	4.5	A
DEP-C-801M-CG	M	F	7'11"	10-20 lbs	1/2-4 oz	2-1/2"	10-3/4"	1-pcs	9 + Tip	6.8	D
DEP-CBR-7101M-T	M	MF	7'10"	6-20 lbs	1/2-3 oz	2-3/4"	12"	1-Tele	9 + Tip	5.6	C
DEP-CBR-861M-T	M	MF	8'6"	6-20 lbs	1/2-3 oz	2-3/4"	12"	1-Tele	9 + Tip	6.5	C

C = Casting Model S = Spinning Model



A Split cork rear grip with pipe reel seat

B Full cork rear grip with pipe reel seat

C Full shrink tube rear grip, EVA foregrip with pipe reel seat



DEAD EYE *Classic*

DEAD EYE CLASSIC RODS

- Technique specific Walleye Trolling and Jigging rods
- Jigging rods are fast and responsive 24-ton carbon blanks
- Trolling models feature rugged and durable E-glass rod blanks
- UFR-1 Ultimate Flex Reinforcement tip technology on jigging rods
- Guide frames on all Classic series rods are rugged stainless steel
- All Classic series rods feature Titanium oxide guide inserts
- Specialized stainless steel tip, prevents inserts from popping out
- Jigging rods feature split or full cork rear grip configuration
- Trolling rods feature durable shrink tube rear grip configuration
- Triangular EVA foregrip on trolling models reduces rod twisting
- Jigging models all feature a traditional cork foregrip
- All Dead Eye rods feature stainless steel hook keepers
- Dead Eye Classic rods are backed by a 1-year limited warranty

MODEL	PWR	TAPER	LENGTH (FT)	LINE WT (LBS)	LURE WT. (OZ)	FOREGRIP LENGTH	REARGRIP LENGTH	SECTIONS	GUIDES	WEIGHT (OZ)	HANDLE
DEAD EYE CLASSIC RODS											
DEC-C-762ML	ML	S	7'6"	8-17 lbs	1/2-2 oz	4-3/4"	12-3/4"	2-pcs	9 + Tip	6.8	C
DEC-C-7101M-T	M	M	7'10"	10-17 lbs	1/4-2-1/2 oz	4-3/4"	12-3/4"	1-Tele	9 + Tip	10.6	C
DEC-C-861M-T	M	M	8'6"	10-20 lbs	1/2-2-1/2 oz	4-3/4"	12-3/4"	1-Tele	9 + Tip	10.8	C
DEC-LC-761M-T	M	M	7'6"	10-20 lbs	1/2-2-1/2 oz	4-3/4"	12-3/4"	1-Tele	7 + Tip	12.0	C
DEC-CBB-701ML	ML	M	7'0"	8-20 lbs	1/2-2 oz	5-1/4"	10-1/2"	1-pcs	8 + Tip	7.9	C
DEC-CBB-761L	L	M	7'6"	8-20 lbs	1/2-2 oz	5-1/4"	10-1/2"	1-pcs	8 + Tip	8.3	C
DEC-S-602-MHFT	MH	F	6'0"	8-15 lbs	3/8-1oz	2"	9"	2-pcs	6 + Tip	4.0	A
DEC-S-662-MFT	M	F	6'6"	6-12 lbs	1/8-5/8 oz	2"	9"	2-pcs	6 + Tip	4.2	A
DEC-S-601-MHFT	MH	F	6'0"	8-15 lbs	3/8-1oz	2"	9"	1-pcs	6 + Tip	4.0	A
DEC-S-661-MLFT	ML	F	6'6"	4-10 lbs	1/16-3/8 oz	2"	9"	1-pcs	6 + Tip	3.6	A
DEC-S-701-MLFT	ML	F	7'0"	4-10 lbs	1/16-3/8 oz	2"	9"	1-pcs	7 + Tip	3.8	A
DEC-S-661-MFT-FG	M	F	6'6"	6-12 lbs	1/8-5/8 oz	2"	9"	1-pcs	6 + Tip	4.6	B
DEC-S-701-MFT-FG	M	F	7'0"	6-12 lbs	1/8-5/8 oz	2"	9"	1-pcs	7 + Tip	4.8	B

C = Casting Model S = Spinning Model





X-SERIES

X-SERIES SALMON & STEELHEAD RODS

- Specially designed rods for Salmon and Steelhead fishing
- Premium 40-Ton Toray carbon rod blank construction
- Double locking Sea Guide Alien reel seat design
- Sea Guide deep press Titanium guide frames
- RS Sea Guide inserts offer unmatched hardness
- Custom 3-K woven carbon cone grip configuration
- X-Series rods are backed by a Limited Lifetime warranty

MODEL	PWR	TAPER	LENGTH (FT)	LINE WT (LBS)	LURE WT. (OZ)	FOREGRIP LENGTH	REARGRIP LENGTH	SECTIONS	GUIDES	WEIGHT (OZ)	HANDLE
X-SERIES SALMON & STEELHEAD RODS											
X-S-761M	M	F	7'6"	8-17 lbs	1/4-1 oz	2-1/2"	9 3/4"	1-pcs	8 + Tip	4.8	A
X-S-932M	M	F	9'3"	8-15 Lbs	1/4-1 oz	2-1/2"	10 3/4"	2-pcs	9 + Tip	5.2	A
X-S-9102M	M	MF	9'10"	8-15lbs	1/4-1 oz	2-1/2"	10 3/4"	2-pcs	10 + Tip	5.6	A
X-S-1062M	M	MF	10'6"	6-15 lbs	1/8-3/4 oz	2-1/2"	10 3/4"	2-pcs	11 + Tip	6.0	A
X-C-932M	M	F	9'3"	8-15 lbs	1/4-1 oz	2-1/2"	14"	2-pcs	12 + Tip	5.8	B
X-C-992M	M	MF	9'9"	6-15 lbs	1/8-3/4 oz	2-1/2"	14"	2-pcs	13 + Tip	6.0	B

C = Casting Model S = Spinning Model



A Split carbon cone rear grip with ALPS double locking seat

B Split carbon cone rear grip with ALPS double locking trigger seat

A Full tapered cork/EVA butt with Fuji spinning reel seat

B Full tapered cork/EVA butt with Fuji trigger reel seat

GLS Custom

GLS CUSTOM RODS

- Specifically, designed blanks for Salmon & Steelhead
- Light and responsive 30-ton carbon rod blanks
- UMR technology: Reduces weight / increases strength
- SCT: Dual helix wrap with over 6000 strands of carbon thread
- Premium deep press stainless steel Sea Guide frames
- Oversized Zirconium guide inserts to reduce freezing
- Features Fuji ACS or TVS reel seat, based on model
- Specialized TPE and premium cork grip configuration
- GLS rods are backed by a 3-year limited warranty

MODEL	PWR	TAPER	LENGTH (FT)	LINE WT (LBS)	LURE WT. (OZ)	FOREGRIP LENGTH	REARGRIP LENGTH	SECTIONS	GUIDES	WEIGHT (OZ)	HANDLE
GREAT LAKES STEELHEAD CUSTOM RODS											
GLS-S-902M	M	M	9'	8-17	3/8-1	2-1/2"	11"	2-pcs	9 + Tip	5.6	A
GLS-S-902MH	MH	MF	9'0"	10-30	3/8-1-1/2	2-1/2"	11"	2-pcs	9 + Tip	5.9	A
GLS-S-962L	L	M	9'6"	4-10	1/8-3/8	2-1/2"	11"	2-pcs	9 + Tip	5.0	A
GLS-S-962ML	ML	MF	9'6"	6-12	1/4-1/2	2-1/2"	11"	2-pcs	9 + Tip	5.4	A
GLS-S-1062ML	ML	MF	10'	6-12	3/16-1/2	2-1/2"	11"	2-pcs	10 + Tip	5.9	A
GLS-S-1062M	M	M	10'6"	8-17	3/8-3/4	2-1/2"	11"	2-pcs	10 + Tip	6.4	A
GLS-C-1102ML	ML	M	11'0"	6-12	3/16-1/2	4"	11-3/4"	2-pcs	11 + Tip	7.0	B
GLS-C-1102M	M	M	11'0"	8-17	3/8-1-1/2	4"	11-3/4"	2-pcs	11 + Tip	7.0	B

C = Casting Model S = Spinning Model



Guide Select Pro

GUIDE SELECT PRO RODS

- 30/40-ton ultra-sensitive & responsive carbon blank
- SeaGuide LBG 316 grade stainless steel guide frames
- All models feature premium Fuji reel seat
- Premium 3K woven carbon fiber fore and rear grips
- Casting models feature a screw down 3K woven carbon foregrip
- Tip over butt ferrule connection for maximum strength & durability
- Stainless steel hook keepers strategically positioned based on technique
- Rod tapers were precision engineered for PNW Salmon and Steelhead fishing
- Trout rods feature fore and rear cork grips
- Guide Select Pro rods are backed by a limited lifetime warranty

MODEL	PWR	TAPER	LENGTH (FT)	LINE WT (LBS)	LURE WT. (OZ)	FOREGRIP LENGTH	REARGRIP LENGTH	SECTIONS	GUIDES	WEIGHT (OZ)	HANDLE
GUIDE SELECT PRO RODS											
GSP-S-761M	M	F	7'6"	8-15 lbs	1/4 - 3/4	2-3/4"	11"	1-pcs	8 + Tip	5.5	A
GSP-S-792L+	L	MF	7'9"	4-12 lbs	1/4 - 3/4	3"	11"	2-pcs	9 + Tip	4.8	D
GSP-S-902ML	ML	MF	9'0"	6-12 lbs	3/8 - 3/4	2-3/4"	11"	2-pcs	9 + Tip	6.0	A
GSP-S-902M	M	MF	9'0"	8-17 lbs	3/8 - 1 oz	2-3/4"	11-1/4"	2-pcs	9 + TIP	6.1	A
GSP-S-902H	H	MF	9'0"	15-40 lbs	1/2 - 3 oz	2-3/4"	12"	2-pcs	9 + TIP	6.7	A
GSP-S-962L	L	M	9'6"	4-10 lbs	1/8 - 3/8 oz	2-3/4"	11-1/4"	2-pcs	9 + TIP	6.1	A
GSP-S-992ML	ML	MF	9'9"	6-12 lbs	3/16 - 1/2 oz	2-3/4"	11-1/4"	2-pcs	9 + TIP	5.8	A
GSP-S-992M	M	F	9'9"	8-17 lbs	3/8 - 1	2-3/4"	11"	2-pcs	9 + Tip	6.1	A
GSP-S-1062ML	ML	MF	10'6"	6-12 lbs	3/16 - 1/2	2-3/4"	11"	2-pcs	10 + Tip	6.6	A
GSP-S-1062M	M	MF	10'6"	8-17 lbs	3/16 - 1/2 oz	2-3/4"	11-1/4"	2-pcs	10 + Tip	6.7	A
GSP-C-822MH	MH	F	8'2"	10-25 lbs	1/2 - 5 oz	4-1/4"	14"	2-pcs	10 + Tip	7.6	B
GSP-C-902H	H	MF	9'0"	15-40 lbs	1/2 - 3 oz	3-1/2"	13-1/2"	2-pcs	11 + Tip	6.7	B
GSP-C-922M	M	F	9'2"	8-17 lbs	3/8 - 1 oz	2-3/4"	14"	2-pcs	11 + Tip	6.4	B
GSP-C-992ML	ML	MF	9'9"	6-12 lbs	3/16 - 1/2 oz	2-3/4"	14"	2-pcs	11 + Tip	6.4	B
GUIDE SELECT PRO TROUT RODS											
GSP-S-761UL	UL	M/MF	7'6"	2-6 lbs	1/8 - 1/2	2"	8-3/4"	1-pcs	7 + Tip	3.6	C
GSP-S-762UL	UL	M/MF	7'6"	2-6 lbs	1/8 - 1/2	2"	8-3/4"	2-pcs	7 + Tip	3.4	C
GSP-S-802UL	UL	M/MF	8'0"	2-6 lbs	1/8 - 1/2	2"	8-3/4"	2-pcs	8 + Tip	4.2	C

C = Casting Model S = Spinning Model



A 3 K woven fore and rear grips with spinning reel seat
B 3 K woven fore and rear grips with trigger reel seat
C Tapered cork fore and rear cork grips
D 3K woven carbon split grip handle with spinning reel seat

GUIDE SELECT CLASSIC RODS

- 24-ton moderate tapered carbon rod blanks
- Rod tapers and powers specifically designed for PNW Salmon
- Premium SeaGuide XBG 316 grade stainless steel guide frames
- Premium Fuji reel seats for maximum durability
- Moderate tapered rod banks specifically designed for PNW Salmon
- Premium 3K woven carbon fiber fore and rear grips
- Carbon Fiber screw down foregrip hides reel seat threads for added comfort
- The combination of materials and tapers make this our most durable Salmon series
- Guide Select Classic rods are backed by a limited lifetime warranty

MODEL	PWR	TAPER	LENGTH (FT)	LINE WT (LBS)	LURE WT. (OZ)	FOREGRIP LENGTH	REARGRIP LENGTH	SECTIONS	GUIDES	WEIGHT (OZ)	HANDLE
GUIDE SELECT CLASSIC RODS											
GSC-C-801M-CG	M	M	7'11"	10-20 lbs	1/4 - 3/4 oz	3"	13-3/4"	1-pcs	13 + Tip	7.4	A
GSC-C-801MH-CG	MH	M	7'11"	12-25 lbs	1/2 - 5 oz	4-1/2"	13-3/4"	1-pcs	13 + Tip	8.0	A
GSC-C-902MH-CG	MH	M	9'0"	12-25 lbs	1 - 6 oz	4-1/4"	13-3/4"	2-pcs	14 + Tip	8.8	A
GSC-C-932H-CG	H	M	9'3"	15-30 lbs	2 - 8 oz	4-1/4"	13-3/4"	2-pcs	14 + Tip	8.4	A
GSC-C-962XH-CG	XH	M	9'6"	20-40 lbs	4 - 16 oz	4-1/4"	13-3/4"	2-pcs	15 + Tip	9.4	A
GSC-C-1062H-CG	H	M	10'6"	15-30 lbs	2 - 8 oz	4-1/4"	13-3/4"	2-pcs	15 + Tip	9.0	A
GSC-C-1062XH-CG	XH	M	10'6"	20-40 lbs	4 - 16 oz	4-1/4"	13-3/4"	2-pcs	15 + Tip	10.0	A
GSC-C-1232XH-CG	XH	M	12'3"	20-40 lbs	4 - 16 oz	4-1/4"	16-3/4"	2-pcs	17 + Tip	11.8	A

C = Casting Models

KOKANEE BLACK RODS

- Specially tapered rod blanks designed for Kokanee fishing
- SeaGuide stainless steel frames with Titanium oxide inserts
- Screw down trigger reel seat on all models
- 3K woven carbon fiber fore and rear grips
- 661ML designed with 24-ton carbon for jigging
- Kokanee Black rods are backed by a limited lifetime warranty

MODEL	PWR	TAPER	LENGTH (FT)	LINE WT (LBS)	LURE WT. (OZ)	FOREGRIP LENGTH	REARGRIP LENGTH	SECTIONS	GUIDES	WEIGHT (OZ)	HANDLE
KOKANEE BLACK JIGGING ROD											
KBJ-C-661ML	ML	M/MF	6'6"	6-10 lbs	1/4 - 1/2 oz	2-1/2"	12"	1-pcs	9 + Tip	5.3	B
KOKANEE BLACK TROLLING RODS											
KB-C-762L	L	M	7'6"	4-8 lbs	1/8 - 3/4 oz	2-1/2"	10-1/4"	2-pcs	11 + Tip	6.8	B
NEW KB-C-762ML	ML	M	7'6"	4-10 lbs	1/4 - 1 oz	2-1/2"	10-1/4"	2-pcs	11 + Tip	5.2	B
KB-C-802L	L	M	8'0"	4-8 lbs	1/8 - 3/4 oz	2-1/2"	11-1/4"	2-pcs	12 + Tip	7.8	B
NEW KB-C-802ML	ML	M	8'0"	4-10 lbs	1/4 - 1 oz	2-1/2"	11-1/4"	2-pcs	12 + Tip	5.4	B
KB-C-902ML	ML	M	9'0"	4-10 lbs	1/4 - 1 oz	2-1/2"	12"	2-pcs	13 + Tip	9.2	B
KB-S-762L	L	M	7'6"	2-8 lbs	1/16 - 1/2 oz	2-1/2"	10-1/4"	2-pcs	6 + Tip	6.8	A
KB-S-802L	L	M	8'0"	2-8 lbs	1/16 - 1/2 oz	2-1/2"	11-1/4"	2-pcs	7 + Tip	7.4	A

C = Casting Model S = Spinning Model

Guide Select Classic



A 3 K woven fore and rear grips with trigger reel seat



A 3K woven carbon butt with pipe reel seat



B 3K woven carbon butt with trigger reel seat

SST CARBON GRIP RODS

SST "A" CARBON GRIP RODS

- Technique and species-specific rod actions
- Light and responsive 24/30-ton low resin carbon blanks
- Deep press guide frames for added durability
- Zirconium inserts offer compatibility for both braid and mono
- Woven carbon fiber fore and rear grip reduces weight
- Precision placed stainless steel hook keeper on all models
- Stainless steel hook keepers on all CG rod models
- SST rods are backed by a 1-year limited warranty

	MODEL	PWR	TAPER	LENGTH (FT)	LINE WT (LBS)	LURE WT. (OZ)	FOREGRIP LENGTH	REARGRIP LENGTH	SECTIONS	GUIDES	WEIGHT (OZ)	HANDLE
NEW	SST-C-791H-CGa	H	MF	7'9"	15 - 30 lbs	1 - 6 oz	2-3/4"	13-1/4"	1-pcs	9+ Tip	6.9	C
	SST-C-7101MGM-CGa	MG-M	F	7'10"	8 - 17 lbs	1/8 - 3/8 oz	2-3/4"	13-1/4"	1-pcs	9+ Tip	6.7	C
	SST-C-862M-CGa	M	M/MF	8'6"	8 - 17 lbs	1/4 - 5/8 oz	2-3/4"	13-1/4"	2-pcs	11+ Tip	7.4	C
	SST-C-862MH-CGa	MH	MF	8'6"	10 - 25 lbs	3/8 - 3/4 oz	2-3/4"	13-1/4"	2-pcs	11+ Tip	8.0	C
	SST-C-902H-CGa	H	MF	9'0"	15 - 50 lbs	1 - 6 oz	4"	13-1/4"	2-pcs	9+ Tip	8.6	B
	SST-C-932MGXH-CGa	MG-XH	F	9'3"	40 - 80 lbs. Braid	2 - 8 oz	4"	13-1/4"	2-pcs	10+ Tip	9.3	B
	SST-C-962XH-CGa	XH	M	9'6"	20 - 50 lbs	4 - 16 oz	4"	13-1/4"	2-pcs	11+ Tip	9.6	B
	SST-C-992H-CGa	H	M	9'9"	15 - 40 lbs	2 - 10 oz	4"	13-1/4"	2-pcs	11+ Tip	9.3	B
	SST-C-1062M-CGa	M	M	10'6"	10 - 20 lbs	1-1/2 oz	2-3/4"	13-1/4"	2-pcs	12+ Tip	8.0	C
	SST-C-1062H-CGa	H	MF	10'6"	15 - 50 lbs	2 - 8 oz	4"	13-1/4"	2-pcs	11+ Tip	8.6	B
	SST-C-1062XH-CGa	XH	MF	10'6"	20 - 60 lbs	4 - 16 oz	4"	14-1/4"	2-pcs	11+ Tip	10.2	B
	SST-S-761M-CGa	M	F	7'6"	8 - 15 lbs	1/4 - 3/4 oz	4"	10-1/4"	1-pcs	8+ Tip	7.0	A
	SST-S-862M-CGa	M	M	8'6"	8 - 17 lbs	1/4 - 5/8 oz	2-3/4"	11"	2-pcs	8+ Tip	6.4	A
	SST-S-862MH-CGa	MH	MF	8'6"	10 - 20 lbs	3/8 - 1-1/2 oz	2-3/4"	11"	2-pcs	8+ Tip	6.7	A
	SST-S-902M-CGa	M	M	9'0"	8 - 17 lbs	3/8 - 1 oz	2-3/4"	11"	2-pcs	9+ Tip	6.1	A
	SST-S-902H-CGa	H	F	9'0"	10 - 30 lbs	3/8 - 1-1/2 oz	2-3/4"	12-1/4"	2-pcs	8+ Tip	8.0	A
	SST-S-962L-CGa	L	M	9'6"	4 - 10 lbs	1/8 - 3/8 oz	2-3/4"	11"	2-pcs	10+ Tip	6.4	A
	SST-S-962ML-CGa	ML	MF	9'6"	6 - 12 lbs	1/4 - 1/2 oz	2-3/4"	11"	2-pcs	10+ Tip	6.7	A
	SST-S-962M-CGa	M	MF	9'6"	8 - 17 lbs	3/8 - 3/4 oz	2-3/4"	11"	2-pcs	10+ Tip	6.7	A
	SST-S-992H-CGa	H	M	9'9"	15 - 40 lbs	1/2 - 3 oz	2-3/4"	11"	2-pcs	10+ Tip	8.6	A
	SST-S-1062ML-CGa	ML	MF	10'6"	6 - 12 lbs	3/16 - 1/2 oz	2-3/4"	11"	2-pcs	11+ Tip	7.0	A
	SST-S-1062M-CGa	M	M	10'6"	8 - 17 lbs	3/8 - 3/4 oz	2-3/4"	11"	2-pcs	11+ Tip	7.0	A

C = Casting Model S = Spinning Model



A Full carbon rear grip with skeleton pipe reel seat

B Full carbon rear grip with skeleton trigger reel seat and double locking nut

C Full carbon rear grip with trigger reel seat and double locking nut

A Full carbon rear grip with skeleton pipe reel seat

B Full carbon rear grip with skeleton trigger reel seat and double locking nut



SST SPECIAL EDITION RODS

SST "A" SPECIAL EDITION RODS

- Technique and species-specific rod actions
- Light and responsive 24/30-ton low resin carbon blanks
- Deep press guide frames for added durability
- Zirconium inserts offer compatibility for both braid and mono
- Woven carbon fiber fore and rear grip reduces weight
- Precision placed stainless steel hook keeper on all models
- Stainless steel hook keepers on all CG rod models
- SST Special Edition rods are backed by a 1-year limited warranty

	MODEL	PWR	TAPER	LENGTH (FT)	LINE WT (LBS)	LURE WT. (OZ)	FOREGRIP LENGTH	REARGRIP LENGTH	SECTIONS	GUIDES	WEIGHT (OZ)	HANDLE
	SST-S-702L-SE-CGa	L	M	7'0"	4 - 10 lbs	1/8 - 3/4 oz	2"	8-3/4"	2-pcs	7+ Tip	4.5	A
	SST-S-902M-SE-CGa	M	M	9'0"	8 - 17 lbs	3/8 - 1 oz	2-3/4"	11"	2-pcs	9+ Tip	6.4	A
	SST-C-902H-SE-CGa	H	MF	9'0"	15 - 50 lbs	1 - 6 oz	4"	13-1/4"	2-pcs	9+ Tip	8.6	B
	SST-C-1062H-SE-CGa	H	MF	10'6"	15 - 50 lbs	2 - 8 oz	4"	13-1/4"	2-pcs	11+ Tip	9.0	B

C = Casting Model S = Spinning Model

SST

SST "A" CORK GRIP RODS

- Technique and species-specific rod actions
- Light and responsive 24/30-ton low resin carbon blanks
- Deep press guide frames for added durability
- Zirconium inserts offer compatibility for both braid and mono
- Premium cork fore and rear grip with rubber cork accents
- Precision placed stainless steel hook keeper on all models
- Stainless steel hook keepers on all cork rod models
- SST rods are backed by a 1-year limited warranty

MODEL	PWR	TAPER	LENGTH (FT)	LINE WT (LBS)	LURE WT. (OZ)	FOREGRIP LENGTH	REARGRIP LENGTH	SECTIONS	GUIDES	WEIGHT (OZ)	HANDLE
SST "A" CORK GRIP RODS											
SST-C-862Ma	M	M/MF	8'6"	8-17 lbs	1/4 - 5/8 oz	2-1/2"	13-1/4"	2-pcs	11+ Tip	6.7	B
SST-C-862MHa	MH	MF	8'6"	10-25 lbs	3/8 - 3/4 oz	2-1/2"	13-1/4"	2-pcs	11+ Tip	7.0	C
SST-C-902Ha	H	MF	9'0"	15-50 lbs	1 - 6 oz	3-1/2"	13-1/4"	2-pcs	9+ Tip	8.0	C
SST-C-962MLa	ML	M	9'6"	6-12 lbs	1/4 - 1/2 oz	2-1/2"	13-1/4"	2-pcs	13+ Tip	7.4	B
SST-C-962Ma	M	—	9'6"	8-17 lbs	3/8 - 1 oz	2-1/2"	13-1/4"	2-pcs	13+ Tip	6.9	B
SST-C-1062Ma	M	M	10'6"	10-20 lbs	3/8 - 1-1/2 oz	2-1/2"	13-1/4"	2-pcs	12+ Tip	7.4	C
SST-C-1062Ha	H	MH	10'6"	15-50 lbs	2 - 8 oz	3-1/2"	13-1/4"	2-pcs	11+ Tip	8.0	C
SST-S-662MLa	ML	MF	6'6"	4-8 lbs	1/8 - 3/8 oz	2"	7-3/4"	2-pcs	6+ Tip	4.2	A
SST-S-662Ma	M	MF	6'6"	6-10 lbs	1/4 - 1/2 oz	2"	7-3/4"	2-pcs	6+ Tip	4.2	A
SST-S-702MLa	ML	M	7'0"	4-8 lbs	1/8 - 3/8 oz	2"	9-1/2"	2-pcs	7+ Tip	4.8	A
SST-S-702Ma	M	MF	7'0"	6-10 lbs	1/4 - 1/2 oz	2"	9-1/2"	2-pcs	7+ Tip	4.8	A
SST-S-762Ma	M	—	7'6"	8-17 lbs	3/8 - 1 oz	2-1/2"	11"	2-pcs	7+ Tip	4.8	A
SST-S-802MHa	MH	F	8'0"	12-30 lbs	1/2 - 2 oz	2-1/2"	11"	2-pcs	7+ Tip	7.0	A
SST-S-862MLa	ML	MF	8'6"	6-12 lbs	3/16 - 1/2 oz	2-1/2"	11"	2-pcs	8+ Tip	5.1	A
SST-S-862Ma	M	M	8'6"	8-17 lbs	1/4 - 5/8 oz	2-1/2"	11"	2-pcs	8+ Tip	5.8	A
SST-S-862MHa	MH	MF	8'6"	10-20 lbs	3/8 - 1-1/2 oz	2-1/2"	11"	2-pcs	8+ Tip	5.8	A
SST-S-902Ma	M	M	9'0"	8-17 lbs	3/8 - 1 oz	2-1/2"	11"	2-pcs	9+ Tip	6.0	A
SST-S-902Ha	H	MF	9'0"	10-30 lbs	1/2 - 2 oz	2-1/2"	12"	2-pcs	8+ Tip	8.0	A
SST-S-962La	L	M	9'6"	4-10 lbs	1/8 - 3/8 oz	2-1/2"	11"	2-pcs	10+ Tip	5.4	A
SST-S-962MLa	ML	MF	9'6"	6-12 lbs	1/4 - 1/2 oz	2-1/2"	11"	2-pcs	10+ Tip	5.9	A
SST-S-962Ma	M	—	9'6"	8-17 lbs	3/8 - 1 oz	2-1/2"	11"	2-pcs	10+ Tip	5.9	A
SST-S-1062MLa	ML	MF	10'6"	6-12 lbs	3/16 - 1/2 oz	2-1/2"	11"	2-pcs	11+ Tip	6.4	A
SST-S-1062Ma	M	M	10'6"	8-17 lbs	3/8 - 3/4 oz	2-1/2"	11"	2-pcs	11+ Tip	6.7	A

C = Casting Model S = Spinning Model



A Full cork rear grip with skeleton pipe reel seat

B Full cork rear grip with trigger reel seat

C Full cork rear grip with trigger reel seat and double locking nut

A Full cork rear grip with skeleton pipe reel seat

B Full cork rear grip with trigger reel seat

C Hard nylon butt section with Fuji reel seat and aluminum gimbal



SST

SST "A" TROUT, KOKANEE, HALIBUT RODS

- Technique and species-specific rod actions
- Light and responsive 24/30-ton low resin carbon blanks
- 1-pcs rod blank design for maximum durability
- Heavy Duty double foot guide frames for added strength
- Zirconium inserts offer compatibility for both braid and mono
- Shrink tube foregrip with hard nylon butt section
- Features gun smoke anodized aluminum rod gimbal
- SST rods are backed by a 1-year limited warranty

MODEL	PWR	TAPER	LENGTH (FT)	LINE WT (LBS)	LURE WT. (OZ)	FOREGRIP LENGTH	REARGRIP LENGTH	SECTIONS	GUIDES	WEIGHT (OZ)	HANDLE
SST "A" KOKANEE AND TROUT RODS											
SST-S-562ULa	UL	M	5'6"	2-6 lbs	1/16 - 3/8 oz	2"	7"	2-pcs	5+ Tip	3.0	A
SST-S-602ULa	UL	M	6'0"	2-6 lbs	1/8 - 3/8 oz	2"	7"	2-pcs	5+ Tip	3.2	A
SST-S-662ULa	UL	M	6'6"	2-6 lbs	1/8 - 3/8 oz	2"	7-3/4"	2-pcs	6+ Tip	3.5	A
SST-S-702ULa	UL	M	7'0"	2-8 lbs	1/8 - 3/8 oz	2"	9-1/2"	2-pcs	7+ Tip	3.8	A
SST-S-702La	L	M	7'0"	4-10 lbs	1/8 - 3/4 oz	2"	8-3/4"	2-pcs	7+ Tip	3.5	A
SST-S-762ULa	UL	M	7'6"	2-6 lbs	1/32 - 3/8 oz	2"	7-3/4"	2-pcs	7+ Tip	3.8	A
SST-S-762La	L	M	7'6"	4-10 lbs	1/8 - 3/4 oz	2"	8-3/4"	2-pcs	7+ Tip	3.8	A
SST-S-802ULa	UL	M	8'0"	2-6 lbs	1/32 - 3/8 oz	2"	8-3/4"	2-pcs	8+ Tip	4.2	A
SST-C-702La	L	M	7'0"	4-10 lbs	1/8 - 3/4 oz	2"	11"	2-pcs	10+ Tip	4.8	B
SST-C-762La	L	M	7'6"	4-12 lbs	1/4 - 1 oz	2"	11"	2-pcs	10+ Tip	5.1	B

SST "A" HALIBUT RODS

SST-C-561Ha	H	MF	5'6"	50-100 lbs	—	15"	10-1/2"	1-pcs	5+ Tip	20.2	C
SST-C-561XHa	XH	MF/F	5'6"	80-120 lbs	—	15"	10-1/2"	1-pcs	5+ Tip	22.1	C

C = Casting Model S = Spinning Model



Celilo

GRAPHITE RODS

CELILO GRAPHITE RODS

- Sensitive graphite composite blanks
- Aluminum oxide guide inserts
- Stainless steel hooded reel seats
- Fore and rear cork grips
- Stainless steel hook keeper
- Thru-blank handle design
- Celilo rods are backed by a 1-year limited warranty

MODEL	PWR	TAPER	LENGTH (FT)	LINE WT (LBS)	LURE WT. (OZ)	FOREGRIP LENGTH	REARGRIP LENGTH	SECTIONS	GUIDES	WEIGHT (OZ)	HANDLE
CELILO GRAPHITE RODS											
CE-C-762Ha	H	MF	7'10"	10-30 lbs	3/4-2-1/2	2-3/4"	13"	2-pcs	8 + Tip	8.8	A
CE-C-862MLa	ML	MF	8'6"	6-12 lbs	3/16-1/2	2-3/4"	12"	2-pcs	9 + Tip	6.8	A
CE-C-862Ma	M	F	8'6"	8-17 lbs	1/4-5/8	2-3/4"	12"	2-pcs	9 + Tip	7.4	A
CE-C-862MHa	MH	F	8'6"	10-20 lbs	3/8-3/4	2-3/4"	12"	2-pcs	9 + Tip	7.6	A
CE-C-862Ha	H	F	8'6"	12-25 lbs	1/2-4	3-1/2"	13-1/2"	2-pcs	9 + Tip	8.4	A
CE-C-902MHa	MH	MF	9'0"	15-50 lbs	1-6	3-1/2"	13-1/2"	2-pcs	9 + Tip	7.8	A
CE-C-902Ha	H	MF	9'0"	15-30 lbs	3/4-4	4"	13-1/2"	2-pcs	9 + Tip	9.0	A
CE-C-962MLa	ML	MF	9'6"	6-12 lbs	1/4-1/2	3-1/2"	12-1/8"	2-pcs	9 + Tip	8.0	A
CE-C-1062MHa	MH	MF	10'6"	15-50 lbs	-	3-1/2"	13-1/2"	2-pcs	12 + Tip	8.4	A
CE-C-1062Ha	H	MF	10'6"	20-60 lbs	-	3-1/2"	14"	2-pcs	12 + Tip	10.2	A
CE-S-862MLa	ML	M	8'6"	6-12 lbs	3/16-1/2	2-1/2"	12"	2-pcs	7 + Tip	7.0	B
CE-S-862Ma	M	MF	8'6"	8-17 lbs	1/4-5/8	2-1/2"	12"	2-pcs	7 + Tip	7.6	B
CE-S-862Ha	H	MF	8'6"	12-25 lbs	1/2-4	3-1/2"	13-1/2"	2-pcs	7 + Tip	9.6	B
CE-S-902MHa	MH	M	9'0"	10-30 lbs	1/2-2 oz	2-1/2"	10-5/8"	2-pcs	8 + Tip	7.4	B
CE-S-962La	L	M	9'6"	4-8 lbs	1/8-3/8	2-1/2"	12"	2-pcs	10 + Tip	7.2	B
CE-S-962MLa	ML	M	9'6"	6-12 lbs	1/4-1/2	3-1/2"	12-1/8"	2-pcs	10 + Tip	7.4	B
CE-S-1002MLa	ML	M	10'	4-12 lbs	1/16-1/4	3-1/2"	14-1/2"	2-pcs	6 + TIP	8.4	B

C = Casting Model S = Spinning Model



A Full Neo cork fore and rear grip with trigger reel seat

B Full Neo cork fore and rear grip with pipe reel seat

A Full Neo cork fore and rear grip with pipe reel seat

B Full Neo cork fore and rear grip with trigger reel seat

Celilo

SPECIALTY

CELILO SPECIALTY RODS

- Sensitive graphite composite blanks
- Aluminum oxide guide inserts
- Stainless steel hooded reel seats
- Aluminum gimbal on Halibut rods
- Rugged graphite butt section on Halibut rod
- Celilo rods are backed by a 1-year limited warranty

MODEL	PWR	TAPER	LENGTH (FT)	LINE WT (LBS)	LURE WT. (OZ)	FOREGRIP LENGTH	REARGRIP LENGTH	SECTIONS	GUIDES	WEIGHT (OZ)	HANDLE
CELILO KOKANE "B" RODS											
NEW CE-S-461ULb	UL	M	4'6"	1-4 lbs	1/32-3/16 oz	1-1/4"	6-1/4"	1-pcs	4+Tip	2.8	A
NEW CE-S-502ULb	UL	M	5'0"	1-4 lbs	1/32-3/16 oz	1-1/4"	6-1/4"	2-pcs	4+Tip	3.0	A
NEW CE-S-562ULb	UL	M	5'6"	2-6 lbs	1/32-1/4 oz	1-1/4"	6-1/4"	2-pcs	5+Tip	3.1	A
NEW CE-S-602ULb	UL	M	6'0"	2-6 lbs	1/32-1/4 oz	1-1/4"	6-1/4"	2-pcs	5+Tip	3.2	A
NEW CE-S-662ULb	UL	M	6'6"	2-6 lbs	1/32-3/8 oz	1-1/4"	6-1/4"	2-pcs	6+Tip	3.4	A
NEW CE-S-702Lb	L	M	7'0"	4-10 lbs	3/16-5/8 oz	2"	7-3/8"	2-pcs	7+Tip	3.8	A
NEW CE-S-762ULb	UL	M	7'6"	2-6 lbs	1/32-3/8 oz	2"	8-1/2"	2-pcs	7+Tip	4.0	A
NEW CE-S-762Lb	L	M	7'6"	4-10 lbs	3/16-5/8 oz	2"	7-3/8"	2-pcs	7+Tip	4.0	A
NEW CE-S-802ULb	UL	M	8'0"	2-6 lbs	1/32-3/8 oz	2"	9-1/2"	2-pcs	8+Tip	4.6	A
NEW CE-S-862ULb	UL	M	8'6"	2-6 lbs	1/32-3/8 oz	2"	10-3/8"	2-pcs	8+Tip	4.6	A
CELILO KOKANE TROLLING RODS											
NEW CE-C-702Lb	L	M	7'0"	2-8 lbs	1/8-1/2 oz	2-1/2"	11"	2-pcs	10+Tip	4.6	B
NEW CE-C-762Lb	L	M	7'6"	4-8 lbs	1/8-3/4 oz	2-1/2"	11"	2-pcs	11+Tip	5.9	B

C = Casting Model S = Spinning Model

CONNOISSEUR

STEELHEAD RODS

CONNOISSEUR RODS

- Steelhead specific rod blank tapers and powers
- Responsive and durable 24-ton carbon blank construction
- UFR-II: Ultimate Flex Reinforcement rod tip technology
- Tip over butt ferrule connection for improved balance
- Traditional full cork rear grip and cork foregrip
- Titanium oxide guide inserts with stainless steel frames
- "L" powered rods are equivalent to Noodle rods
- Stainless steel hook keepers on all CQ models
- Connoisseur rods are backed by a 1-year limited warranty

MODEL	PWR	TAPER	LENGTH (FT)	LINE WT (LBS)	LURE WT. (OZ)	FOREGRIP LENGTH	REARGRIP LENGTH	SECTIONS	GUIDES	WEIGHT (OZ)	HANDLE
CONNOISSEUR RODS											
CQ-C-862MHa	MH	MF	8'6"	8-20 lbs	3/8-1	3"	12"	2-pcs	8 + Tip	7.4	B
CQ-S-862Ma	M	MF	8'6"	10-20 lbs	1/8-1/4	4"	10"	2-pcs	9 + Tip	6.7	A
CQ-S-862MHa	MH	MF	8'6"	15-25 lbs	1/2-4	4"	10"	2-pcs	9 + Tip	7.1	A
CQ-S-902La	L	M	9'0"	2-8 lbs	1/16-1/4	7"	8"	2-pcs	9 + Tip	5.5	A
CQ-S-902MLa	ML	MF	9'0"	6-12 lbs	1/8-1/4	5"	8"	2-pcs	9 + Tip	5.7	A
CQ-S-962MLa	ML	MF	9'6"	6-12 lbs	1/8-1/4	5"	8"	2-pcs	9 + Tip	5.9	A
CQ-S-1002La	L	M	10'0"	2-10 lbs	1/16-1/4	7"	9"	2-pcs	9 + Tip	6.1	A
CQ-S-1002MLa	ML	MF	10'0"	6-12 lbs	1/8-1/4	5"	8"	2-pcs	9 + Tip	6.4	A
CQ-S-1102La	L	M	11'0"	4-10 lbs	1/16-1/4	7"	10"	2-pcs	12 + Tip	7.3	A

C = Casting Model S = Spinning Model



A Spinning reel seat with cork fore and rear grips

B Trigger reel seat with cork fore and rear grips

WHITE DIAMOND RODS

- Carbon and glass blank construction for maximum durability
- Copper/Leadcore rod WD-CL-862M is tubular glass based on application
- UFR: Ultimate Flex Reinforcement rod tip technology
- Low profile stainless steel guide frames and inserts
- Wire/Copper/Leadcore trolling rods feature welded stainless steel guides
- Rods designated with "WL" in the model feature a swivel roller tip top.
- White upper blank section designed for increased visibility and bite indicator
- Cushioned stainless steel hooded reel seat.
- Triangular shaped EVA foregrip prevents twisting while fishing a fish.
- Durable non-skid, rubber gimbal on all models
- All White Diamond rods are 2-pcs blank construction
- White Diamond rods are backed by a 1-year limited warranty

MODEL	PWR	TAPER	LENGTH (FT)	LINE WT (LBS)	LURE WT. (OZ)	FOREGRIP LENGTH	REARGRIP LENGTH	SECTIONS	GUIDES	WEIGHT (OZ)	HANDLE
WHITE DIAMOND RODS											
WD-DR-762ML	ML	S/M	7'6"	8-17 lbs	1/32-3/16	6"	11-3/8"	2-pcs	9 + Tip	7.4	A
WD-DR-802M	M	S/M	8'0"	12-25 lbs	1/32-3/16	6"	11-3/8"	2-pcs	9 + Tip	8.0	A
WD-DR-862ML	ML	S/M	8'6"	8-17 lbs	1/32-1/4	6"	11-3/8"	2-pcs	11 + Tip	8.0	A
WD-DR-862M	M	S/M	8'6"	12-25 lbs	1/32-1/4	6"	11-3/8"	2-pcs	11 + Tip	8.3	A
WD-DD-1002MH	MH	M	10'0"	12-30 lbs	1/32-3/8	6"	13-1/2"	2-pcs	10 + Tip	9.9	A
WD-CL-862M	M	M/MF	8'6"	12-25 lbs	3/16-5/8	6-1/4"	11-3/4"	2-pcs	8 + Tip	14.1	A
WD-WL-862MH	MH	M	8'6"	WIRE	1/32-3/8	6-1/4"	12-3/4"	2-pcs	6 + Tip	10.6	A
WD-WL-1002MH	MH	M	10'0"	WIRE	3/16-5/8	6-1/4"	12-3/4"	2-pcs	7 + Tip	13.8	A

BLUE DIAMOND RODS

- Extremely durable carbon and glass blank mixture for ultimate strength
- EVA fore and rear grips for comfort and durability
- Polished Titanium oxide guide inserts
- Double foot, stainless steel guide frames
- Cushioned stainless steel hooded reel seat
- Durable non-skid, rubber gimbal on all models
- Technique-specific rod designs for Downrigger, Planer and Dipsy
- All Blue Diamond Rods are 2-pcs blank construction
- Blue Diamond rods are backed by a 1-year limited warranty

MODEL	PWR	TAPER	LENGTH (FT)	LINE WT (LBS)	LURE WT. (OZ)	FOREGRIP LENGTH	REARGRIP LENGTH	SECTIONS	GUIDES	WEIGHT (OZ)	HANDLE
BLUE DIAMOND RODS											
BD-C-762MLa	ML	S/M	7'6"	8-20 lbs	-	6"	11-3/8"	2-pcs	9 + Tip	7.7	A
BD-C-802Ma	M	S/M	8'0"	12-25 lbs	-	6"	11-3/8"	2-pcs	9 + Tip	8.6	A
BD-C-862MLa	ML	S/M	8'6"	8-17 lbs	-	6"	11-3/8"	2-pcs	11 + Tip	9.0	A
BD-C-862Ma	M	S/M	8'6"	12-25 lbs	-	6"	11-3/8"	2-pcs	11 + Tip	9.0	A
BD-C-862MHa	MH	M	8'6"	12-30 lbs	-	6"	11-3/8"	2-pcs	11 + Tip	9.6	A
BD-C-902Ma	M	M	9'0"	12-25 lbs	-	6"	13-3/4"	2-pcs	10 + Tip	9.3	A
BD-C-1002MHa	MH	M	10'0"	12-30 lbs	-	6"	13-3/4"	2-pcs	10 + Tip	10.2	A

C = Casting Model



A Standard pipe reel seat with Triangle shaped foregrip

Blue Diamond



A EVA fore and rear grips with rubber gimbal

CLASSIC PRO GLT

CLASSIC PRO GLT RODS

- Salmon and Striper specialty rods
- Durable E-glass blank construction
- Durable titanium oxide guide inserts
- Stainless steel guide frames
- Copper line rod features stainless steel welded guides
- Triangular shaped EVA foregrip (All models but spinning)
- Rubber shrink tube butt. Improves rod holder removal and durability
- Casting guides are all double foot construction
- Precision Trolling models are telescopic Salmon trolling rods
- All rods feature a custom mirror finished rod blank
- Tip over butt ferrule connection for increased strength
- Stainless steel hook keepers
- Classic Pro GLT rods are backed by a 1-year limited warranty

MODEL	PWR	TAPER	LENGTH (FT)	LINE WT (LBS)	FOREGRIP LENGTH	REARGRIP LENGTH	SECTIONS	GUIDES	WEIGHT (OZ)	HANDLE
CLASSIC PRO GLT RODS										
CP-LT-762M	M	MF	7'6"	12-20 lbs	5-1/2"	11"	2-pcs	7 + Tip	10.9	A
CP-DR-702M	M	S	7'0"	10-20 lbs	5-1/2"	11"	2-pcs	9 + Tip	7.5	A
CP-DR-762ML	ML	S	7'6"	8-20 lbs	5-1/2"	11"	2-pcs	9 + Tip	9.9	A
CP-DR-802M	M	S	8'0"	10-20 lbs	5-1/2"	9-3/4"	2-pcs	11 + Tip	11.5	A
CP-DR-862M	M	S	8'6"	10-25 lbs	6-3/4"	11-3/4"	2-pcs	11 + Tip	11.2	A
CP-DD-902M	M	M	9'0"	10-25 lbs	6-3/4"	11"	2-pcs	11 + Tip	13.1	A
CP-DD-1002M	M	M	10'0"	12-30 lbs	7-3/4"	12"	2-pcs	11 + Tip	17.1	A
CP-DD-1062M	M	M	10'6"	12-30 lbs	8-3/4"	12"	2-pcs	10 + Tip	19.5	A
CP-PB-7101M-T	M	M	7'10"	10-20 lbs	2-3/4"	12-3/4"	1-tele	8 + Tip	12.2	B
CP-PB-861M-T	M	M/MF	8'6"	10-20 lbs	2-3/4"	12"	1-tele	9 + Tip	10.9	A
CP-CL-862M	M	M/MF	8'6"	12-27 lbs	6-3/4"	9"	2-pcs	11 + Tip	13.1	A
CP-C-862M	M	M	8'6"	10-20 lbs	4-1/2"	11"	2-pcs	11 + Tip	12.5	A
CP-C-862MH	MH	M	8'6"	12-25 lbs	4-1/2"	11"	2-pcs	11 + Tip	12.0	A
CP-C-902MH	MH	M	9'0"	12-25 lbs	4-1/2"	11"	2-pcs	11 + Tip	12.8	A
CST-LB-701ML	ML	S/M	7'0"	6-20 lbs	5-1/4"	10-1/2"	1-pc	8 + Tip	9.0	C
CST-LB-761ML	ML	M	7'6"	10-20 lbs	5-1/4"	12"	1-pc	9 + Tip	9.1	C
CST-UR-761MH	MH	M/MF	7'6"	12-25 lbs	8"	14"	1-pc	8 + Tip	16.0	C



A Standard pipe reel seat with shrink tube butt section, no gimbal



B Standard pipe reel seat with EVA grips



C Trigger reel seat with shrink tube butt section, no gimbal



A EVA foregrip and rear grip with Fuji reel seat



B EVA foregrip and rear grip with Okuma aluminum reel seat



C EVA foregrip and rear grip with Okuma aluminum reel seat and gimbal



SCT **Albacore**

SCT ALBACORE RODS

- UFR: Ultimate Flex Reinforcement technology increases rod's lifting power and maximum strength
- Extremely lightweight and responsive 24-ton carbon rod blanks
- SCT blanks: Spiral Carbon Technology improved strength and durability
- SCT is a dual helix wrap configuration with over 6000 strands of carbon fiber
- ALPS stainless steel deep pressed guide frames
- Titanium oxide ALPS guide inserts
- EVA foregrip and rear grips for maximum durability
- Fuji DPS reel seat on spinning models
- Okuma machined aluminum reel seats on trolling and casting models
- Aluminum gimbal on Albacore trolling rods
- SCT Albacore rods are backed by a limited lifetime warranty

MODEL	PWR	TAPER	LENGTH (FT)	LINE WT (LBS)	LURE WT. (OZ)	FOREGRIP LENGTH	REARGRIP LENGTH	SECTIONS	GUIDES	WEIGHT (OZ)	HANDLE
SCT ALBACORE RODS											
SCT-AC-661MH	MH	MF	6'6"	20-50 lbs	-	6-1/2"	14-1/4"	1-pc	9 + Tip	13.8	B
SCT-AC-701MH	MH	MF	7'0"	20-50 lbs	-	6-1/2"	14-1/4"	1-pc	9 + Tip	15.4	B
SCT-AT-601H	H	MF	6'0"	30-60 lbs	-	6-1/2"	14-1/4"	1-pc	8 + Tip	15.0	C
SCT-AS-701MH	MH	MF	7'0"	20-50 lbs	-	6-1/2"	12"	1-pc	7 + Tip	13.8	A



PCH Custom

PCH CUSTOM RODS

- Extremely lightweight and responsive 24-ton carbon rod blanks
- UFR-II: Ultimate Flex Reinforcement rod tip technology
- 3K-woven carbon outer blank wrap improves hoop strength
- M, MH and H models feature Fuji K-guides with Alconite inserts
- XH models feature ALPS HXN guides with Zirconium inserts
- All models feature machined aluminum reel seats
- 7" and 7'6" rods feature tapered TPE fore and rear grips
- 8' rods featured tapered shrink tube for durability and comfort
- All PCH models feature ALPS non-skid rubber butt caps
- PCH-KT-2101-CG custom designed for kite fishing
- Popping rod features reversed stripper guide for reduced tangles
- PCH Custom rods are backed by a limited lifetime warranty

MODEL	PWR	TAPER	LENGTH (FT)	LINE WT (LBS)	LURE WT. (OZ)	FOREGRIP LENGTH	REARGRIP LENGTH	SECTIONS	GUIDES	WEIGHT (OZ)	HANDLE
PCH CUSTOM RODS											
PCH-C-701M	M	F	7'0"	12-25 lbs	—	12"-1/2"	13"-1/4"	1-pcs	9 + Tip	11.5	A
PCH-C-701H	H	F	7'0"	20-50 lbs	—	12"-1/2"	13"-1/4"	1-pcs	9 + Tip	13.4	A
PCH-C-701XH	XH	F	7'0"	30-60 lbs	—	12"-1/2"	13"-1/4"	1-pcs	9 + Tip	15.7	A
PCH-C-701XXH	XXH	F	7'0"	40-80 lbs	—	15'-1/2"	14'-1/2"	1-pcs	9 + Tip	21.4	F
PCH-C-741XXH	XXH	F	7'4"	60-100 lbs	—	18"	15"	1-pcs	9 + Tip	18.6	D
PCH-C-741XXXH	XXXH	F	7'4"	80-130 lbs	—	18"	15"	1-pcs	9 + Tip	24.0	D
PCH-C-741XXXXH	XXXXH	F	7'4"	150-200 lbs	—	20"	15"	1-pcs	9 + Tip	32.3	E
PCH-C-761M	M	F	7'6"	12-25 lbs	—	12"-1/2"	13"-1/4"	1-pcs	9 + Tip	13.4	A
PCH-C-761H	H	F	7'6"	20-50 lbs	—	12"-1/2"	13"-1/4"	1-pcs	9 + Tip	14.1	A
PCH-C-761XH	XH	F	7'6"	30-60 lbs	—	12"-1/2"	13"-1/4"	1-pcs	9 + Tip	15.4	A
PCH-C-801MH	MH	F	8'0"	15-40 lbs	—	12"-1/2"	13"-1/4"	1-pcs	10 + Tip	14.4	B
PCH-C-801H	H	F	8'0"	20-50 lbs	—	12"-1/2"	13"-1/4"	1-pcs	10 + Tip	15.4	B
PCH-C-801XH	XH	F	8'0"	30-60 lbs	—	12"-1/2"	13"-1/4"	1-pcs	10 + Tip	16.6	B
PCHP-S-761MH	MH	MF/F	7'6"	40 - 60 lbs	1 - 6 oz	7"-3/4"	16"-7/8"	1-pcs	6 + Tip	15.0	C
PCHP-S-761H	H	MF/F	7'6"	50 - 80 lbs	2 - 8 oz	7"-3/4"	16"-7/8"	1-pcs	6 + Tip	16.0	C
PCHP-S-761XH	XH	MF/F	7'6"	60 - 100 lbs	2 - 10 oz	7"-3/4"	16"-7/8"	1-pcs	6 + Tip	17.0	C
PCH-S-701M	M	F	7'0"	12-30 lbs	—	11'-1/2"	13"	1-pcs	6 + Tip	13.1	H
PCH-S-701MH	MH	F	7'0"	15-30 lbs	—	11'-1/2"	13"	1-pcs	6 + Tip	14.1	H
PCH-S-701H	H	F	7'0"	20-40 lbs	—	11'-1/2"	13"	1-pcs	6 + Tip	13.4	H
PCH KITE ROD											
PCH-KT-2101-CG	—	—	2'10"	—	—	7"	13"	1-pcs	Tip only	16.6	G

C = Casting Model S = Spinning Model



A TPE fore and rear grip with Aluminum reel seat and ALPS rubber butt cap



B Tapered shrink tube fore and rear grip with Aluminum reel seat and ALPS rubber butt cap



C TPE foregrip with split rear grip and Aluminum reel seat



D Shrink tube fore and rear grips with Aluminum reel seat and gimbal

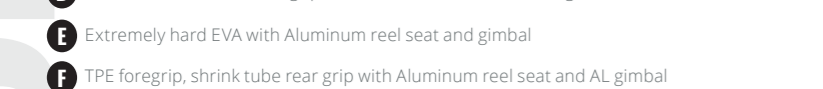

E Extremely hard EVA with Aluminum reel seat and gimbal

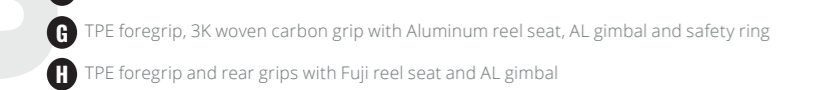

F TPE foregrip, shrink tube rear grip with Aluminum reel seat and AL gimbal



G TPE foregrip, 3K woven carbon grip with Aluminum reel seat, AL gimbal and safety ring



H TPE foregrip and rear grips with Fuji reel seat and AL gimbal

PCH Custom INSHORE RODS



A Cork/TPE combination grips with Fuji reel seat



B Cork/TPE combination grips with Fuji trigger reel seat



C Cork/TPE combination grips with Fuji trigger reel seat

PCH CUSTOM INSHORE RODS

- Extremely lightweight and responsive 24-ton carbon rod blanks
- UFR-II: Ultimate Flex Reinforcement rod tip technology
- 3K-woven carbon outer blank wrap improves hoop strength
- Features Fuji K-guide concept frames to reduce wind knots
- PCH inshore models all feature Alconite inserts to reduce abrasion
- Premium Fuji reel seat for maximum reel support
- Custom cork and TPE grip configuration for comfort and durability
- "SG" models feature a rear cork split grip design for reduced weight
- ALPS non-skid rubber butt cap ads comfort and protects your boat
- All PCH inshore rods feature an oversized stainless-steel hook keeper
- PCH inshore rods are backed by a limited lifetime warranty

MODEL	PWR	TAPER	LENGTH (FT)	LINE WT (LBS)	LURE WT. (OZ)	FOREGRIP LENGTH	REARGRIP LENGTH	SECTIONS	GUIDES	WEIGHT (OZ)	HANDLE
PCH CUSTOM INSHORE RODS											
PCHI-C-761M	M	F	7'6"	12-25 lbs	3/4 - 1-1/2 oz	2-3/4"	13"	1-pcs	9 + Tip	10.9	B
PCHI-C-761H	H	F	7'6"	20-40 lbs	1 - 3 oz	2-3/4"	13"	1-pcs	9 + Tip	11.8	B
PCHI-C-801MH	MH	F	8'0"	15-30 lbs	1 - 2-3/4 oz	2-3/4"	14"	1-pcs	10 + Tip	12.2	B
PCHI-C-801H	H	F	8'0"	20-40 lbs	1 - 3 oz	2-3/4"	14"	1-pcs	10 + Tip	11.2	B
PCHI-C-801H-SG	H	MF/F	8'0"	15 - 30 lbs	1 - 3 oz	4"	14-1/4"	1-pcs	10 + Tip	9.9	C
PCHI-C-801XH-SG	XH	MF/F	8'0"	20 - 40 lbs	1-1/2 - 4-1/2 oz	4"	14-1/4"	1-pcs	10 + Tip	10.9	C

C = Casting Model S = Spinning Model

PCH Custom TROLLING RODS



A Shrink tube foregrip with straight carbon butt and aluminum reel seat



B Shrink tube foregrip with bent carbon butt and aluminum reel seat

PCH TROLLING RODS

- Durable 24-ton carbon and E-Glass constructed rod blanks
- 3K-woven carbon outer blank wrap improves hoop strength
- ALPS RX series roller guides with 316 stainless steel rollers
- Proprietary curved or straight woven carbon fiber butt sections
- Detachable butt section with machined aluminum reel seats
- Tapered shrink tube foregrips offer maximum durability
- PCH Trolling rods are backed by a limited lifetime warranty

MODEL	PWR	TAPER	LENGTH (FT)	LINE WT (LBS)	FOREGRIP LENGTH	REARGRIP LENGTH	SECTIONS	GUIDES	WEIGHT (OZ)	HANDLE
PCH TROLLING RODS										
PCH-TRS-561M	M	MF/F	5'6"	40 - 100 lbs	13"	13"	1-pcs	4 + Tip	27.2	A
PCH-TRS-561MH	MH	MF/F	5'6"	60 - 130 lbs	13"	13"	1-pcs	4 + Tip	28.5	A
PCH-TRS-5101H	H	MF/F	5'10"	80 - 150 lbs	11"	14"	1-pcs	4 + Tip	28.5	A
PCH-TRS-5101XH	XH	MF/F	5'10"	100 - 250 lbs	11"	14"	1-pcs	4 + Tip	32.0	A
PCH-TRS-661M	M	MF/F	6'6"	40 - 100 lbs	13"	13"	1-pcs	5 + Tip	30.1	A
PCH-TRS-661MH	MH	MF/F	6'6"	60 - 130 lbs	13"	13"	1-pcs	5 + Tip	31.0	A
PCH-TRS-6101H	H	MF/F	6'10"	80 - 150 lbs	11"	15-1/2"	1-pcs	5 + Tip	32.3	A
PCH-TRS-6101XH	XH	MF/F	6'10"	100 - 250 lbs	11"	15-1/2"	1-pcs	5 + Tip	32.3	A
PCH-TRB-5101H	H	MF/F	5'10"	80 - 150 lbs	11"	14"	1-pcs	5 + Tip	33.6	B
PCH-TRB-5101XH	XH	MF/F	5'10"	100 - 250 lbs	11"	14"	1-pcs	5 + Tip	35.2	B
PCH-TRB-6101H	H	MF/F	6'10"	80 - 150 lbs	11"	15-1/2"	1-pcs	5 + Tip	32.0	B
PCH-TRB-6101XH	XH	MF/F	6'10"	100 - 250 lbs	11"	15-1/2"	1-pcs	5 + Tip	40.0	B



MAKAIRA

SALTWATER CARBON TECHNOLOGY

ALPS RX PREMIUM ROLLER GUIDES

* Tournament IGFA series rods feature black and gold RX roller guides
 * All Roller Trolling rods feature gunsmoke RX roller guides

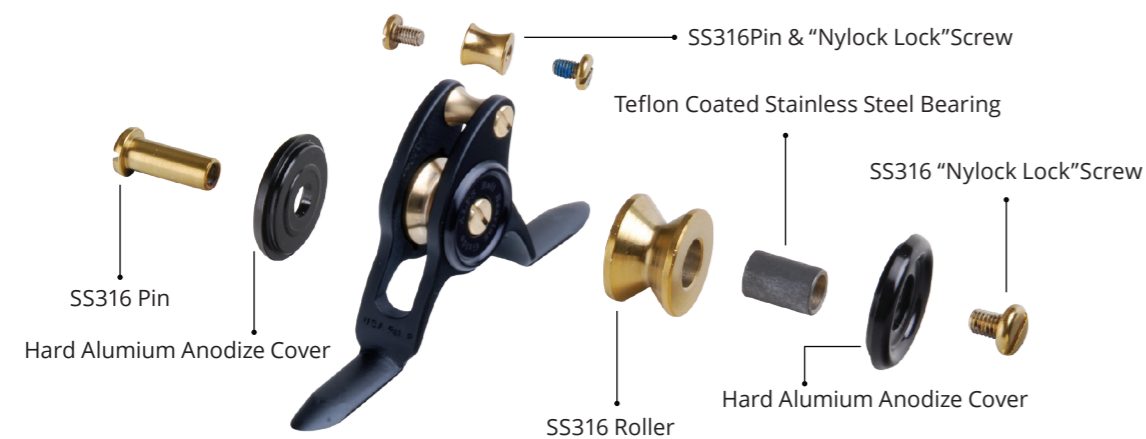

A Makaira Trolling: Aluminum reel seat with shrink tube grips and aluminum gimbal

B Makaira Trolling: ALPS aluminum butt section

C Makaira Trolling: Bent butt section

MAKAIRA

SALTWATER CARBON TECHNOLOGY

MAKAIRA TROLLING RODS

- Carbon composite rod blank technology
- ALPS deep press 316 stainless guide frames
- Custom aluminum reel seats with Abalone under lay
- IGFA tournament rods with full straight or bent aluminum rod butts
- Shrink tube grips for ultimate durability
- ALPS roller guides on trolling rods with large knot clearance
- Aluminum gimbals on trolling rods
- Custom abalone decoration above fore grip
- Durable shrink tube foregrips on all trolling models
- Makaira rods are backed by a limited lifetime warranty

MODEL	PWR	TAPER	LENGTH (FT)	LINE WT (LBS)	LURE WT. (OZ)	FOREGRIP LENGTH	REARGRIP LENGTH	SECTIONS	GUIDES	WEIGHT (OZ)	HANDLE
MAKAIRA TROLLING ROLLER GUIDE RODS											
MK-TR-601H	H	M/MF	6' 0"	30-80 lbs	—	16"	11-5/8"	1-pc	5 + Tip	25.2	A
MK-TR-601XH	XH	M/MF	6' 0"	40-100 lbs	—	16"	11-5/8"	1-pc	5 + Tip	26.1	A
MK-TR-601XXH	XXH	M/MF	6' 0"	50-120 lbs	—	16"	11-5/8"	1-pc	5 + Tip	27.0	A
MAKAIRA STRAIGHT & BENT BUTT RODS											
MK-TR-581-30S	H	M/MF	5' 8"	30-lbs IGFA	—	11-3/4"	4 + Tip	2-pcs	4 + Tip	35.7	B
MK-TR-581-50S	XH	M/MF	5' 8"	50-lbs IGFA	—	11-3/4"	4 + Tip	2-pcs	4 + Tip	37.2	B
MK-TR-5101-80B	XXH	M/MF	5' 10"	80-lbs IGFA	—	14-3/4"	4 + Tip	2-pcs	4 + Tip	47.0	C

TR = Trolling Model

CEDROS "A"



A Split EVA rear grip with aluminum reel seat and rubber butt cap



B Full EVA rear grip with aluminum reel seat and aluminum gimbal

CEDROS "A" JIGGING RODS

- E-glass blank offers incredible pulling power
- Glass blanks offer shock reduction when using braided line
- Zirconium guide inserts reduce friction from braided lines
- ALPS high-rise 316 stainless steel guide frames
- High-rise frames keep the line off the blank and fore grip
- Okuma machined aluminum, two tone anodized reel seat
- Pyramid reel seat is more ergonomic and offers more control
- Ribbed EVA fore grip improves grip and rod control
- Cedros rods are backed by a limited lifetime warranty

MODEL	PWR	TAPER	LENGTH (FT)	LINE WT (LBS)	LURE WT.	FOREGRIP LENGTH	REARGRIP LENGTH	SECTIONS	GUIDES	WEIGHT (OZ)	HANDLE
CEDROS "A" JIGGING RODS											
CJ-C-561XHa	XH	F/XF	5'6"	65 - 200 lbs	300-500g	8"	12-1/4"	1-pc	6 + Tip	16.3	B
CJ-C-561XXHa	XXH	MF/F	5'6"	80 - 200 lbs	500-700g	8"	12-1/4"	1-pc	6 + Tip	16.0	B
CJ-C-601MHa	MH	MF	6'0"	50 - 100 lbs	90-200g	7-1/2"	14"	1-pc	8 + Tip	13.4	A
CJ-C-601Ha	H	MF	6'0"	65 - 150 lbs	160-325g	7-1/2"	14"	1-pc	8 + Tip	15.7	A
CJ-C-601XHa	XH	MF/F	6'0"	65 - 200 lbs	300-500g	7-1/2"	14"	1-pc	8 + Tip	15.4	A
CJ-C-661Ma	M	M	6'6"	30 - 65 lbs	30-160g	7-1/2"	13-1/2"	1-pc	8 + Tip	12.8	A
CJ-C-661MHa	MH	MF	6'6"	50 - 100 lbs	90-200g	7-1/2"	13-1/2"	1-pc	8 + Tip	15.0	A
CJ-C-661Ha	H	MF/F	6'6"	65 - 150 lbs	160-325g	7-1/2"	13-1/2"	1-pc	8 + Tip	17.0	A
CJ-C-661XHa	XH	MF/F	6'6"	65 - 200 lbs	300-500g	7-1/2"	13-1/2"	1-pc	8 + Tip	16.3	A
CJ-S-601MHa	MH	M/MF	6'0"	50 - 100 lbs	90-200g	7-1/2"	14"	1-pc	5 + Tip	14.4	A
CJ-S-601Ha	H	MF	6'0"	65 - 150 lbs	160-325g	7-1/2"	14"	1-pc	5 + Tip	16.3	A
CJ-S-701Ma	M	M	7'0"	30 - 65 lbs	30-160g	7-1/2"	14"	1-pc	7 + Tip	14.7	A
CJ-S-701MHa	MH	M/MF	7'0"	50 - 100 lbs	90-200g	7-1/2"	14"	1-pc	7 + Tip	17.6	A
CJ-S-701Ha	H	MF	7'0"	65 - 150 lbs	160-325g	7-1/2"	14"	1-pc	7 + Tip	18.9	A

C = Casting Model S = Spinning Model

MONTEREY SALMON, HALIBUT & STURGEON RODS

- Responsive and durable 24-ton carbon and E-Glass blanks
- UFR: Ultimate Flex Reinforced rod tip technology
- 3K-woven carbon outer blank wrap improves hoop strength
- SeaGuide XQ series 316 stainless steel guide frames
- Zirconium inserts offer compatibility for both braid and mono
- Premium Fuji DPS reel seat with stainless steel hoods
- Comfortable EVA foam fore grip with shrink tube rear grip
- All models feature a precision placed stainless steel hook keeper
- Monterey rods are backed by a limited lifetime warranty

MODEL	PWR	TAPER	LENGTH (FT)	LINE WT (LBS)	LURE WT. (OZ)	FOREGRIP LENGTH	REARGRIP LENGTH	SECTIONS	GUIDES	WEIGHT (OZ)	HANDLE
MONTEREY SALMON, HALIBUT & STURGEON RODS											
MON-HS-801M+	M+	M/MF	8'0"	12 - 25 lbs	-	10"	13-3/4"	1-pcs	9 + Tip	11.8	A
MON-HS-801MH	MH	M/MF	8'0"	15 - 30 lbs	-	10"	13-3/4"	1-pcs	9 + Tip	13.8	A

MONTEREY



A EVA foregrip, shrink tube rear grip and Fuji DPS reel seat



A EVA foregrip and rear grip with Fuji reel seat

CAVALLA BOAT RODS

CAVALLA BOAT RODS

- Responsive and durable 24-ton carbon rod blanks
- UFR: Ultimate Flex Reinforced rod tip technology
- SeaGuide deep pressed, 316-grade stainless steel guide frames
- Zirconium inserts offer compatibility for both braid and mono
- Premium Fuji DPS reel seat with stainless steel hoods
- Comfortable and durable EVA foam fore and rear grips
- All models feature a precision placed stainless steel hook keeper
- Cavalla rods are backed by a 1-year limited warranty

MODEL	PWR	TAPER	LENGTH (FT)	LINE WT (LBS)	FOREGRIP LENGTH	REARGRIP LENGTH	SECTIONS	GUIDES	WEIGHT (OZ)	HANDLE
CAVALLA BOAT RODS										
CAV-C-601XH	XH	M/MF	6'0"	40-100 lbs	8"	12-1/2"	1-pcs	9 + Tip	9.9	A
NEW CAV-C-601MH	MH	F	6'0"	15-40 lbs	11-1/2"	12"	1-pcs	8+Tip	9.5	A
NEW CAV-C-601H	H	F	6'0"	20-50 lbs	11-1/2"	12"	1-pcs	8+Tip	9.6	A
NEW CAV-C-661MH	MH	F	6'6"	15-40 lbs	12-1/4"	12-3/4"	1-pcs	9+Tip	10.3	A
NEW CAV-C-661H	H	F	6'6"	20-50 lbs	12-1/4"	12-3/4"	1-pcs	9+Tip	11.0	A
CAV-C-701M	M	F	7'0"	12 - 25 lbs	13"	13-3/4"	1-pcs	9 + Tip	10.9	A
CAV-C-701MH	MH	F	7'0"	15 - 40 lbs	13"	13-3/4"	1-pcs	9 + Tip	12.0	A
CAV-C-701H	H	F	7'0"	20 - 50 lbs	13"	13-3/4"	1-pcs	9 + Tip	12.5	A
CAV-C-701XH	XH	F	7'0"	30 - 60 lbs	13"	13-3/4"	1-pcs	9 + Tip	14.1	A
NEW CAV-S-601MH	MH	F	6'0"	15-30 lbs	9-1/4"	11-1/2"	1-pcs	5+Tip	9.7	A
NEW CAV-S-661MH	MH	F	6'6"	15-30 lbs	9-1/4"	12-1/4"	1-pcs	6+Tip	10.7	A
CAV-S-701M	M	F	7'0"	12 - 25 lbs	10-3/4"	13"	1-pcs	6 + Tip	11.7	A
CAV-S-701MH	MH	F	7'0"	15 - 30 lbs	10-3/4"	13"	1-pcs	6 + Tip	12.6	A

C = Casting Model S = Spinning Model

ECS *Custom*



- A** Shrink tube grips with aluminum gimbal and reel seat
- B** Tapered EVA grips with aluminum gimbal and reel seat
- C** Graphite butt with aluminum gimbal and reel seat
- D** Graphite butt with aluminum gimbal and reel seat
- E** Neptune aluminum folding butt and EVA foregrip

ECS *Custom*

ECS CUSTOM RODS

- Hybrid 24-ton carbon and e-glass blank construction
- UFR-II: Ultimate Flex Reinforcement rod tip technology
- ALPS deep press 316-grade SS frames with Zirconium inserts
- Model featuring roller guides use ALPS RX series rollers
- TR models: SeaGuide Neptune adjustable rod butt
- Machined aluminum, anodized rod gimbal
- ECS Custom rods are backed by a 3-year limited warranty

	MODEL	PWR	TAPER	LENGTH (FT)	LINE WT (LBS)	FOREGRIP LENGTH	REARGRIP LENGTH	SECTIONS	GUIDES	WEIGHT (OZ)	HANDLE
ECS CUSTOM RODS											
NEW	ECS-S-601H	H	MF	6'0"	50-100 lbs	8"	12-3/4"	1-pcs	5+ Tip	14.2	A
NEW	ECS-S-661MH	MH	MF	6'6"	30-80 lbs	8"	12-3/4"	1-pcs	5+ Tip	14.8	A
NEW	ECS-C-601H	H	MF	6'0"	50-130 lbs	8"	12-1/4"	1-pcs	8+ Tip	12.8	B
NEW	ECS-C-661XH	XH	MF	6'6"	80-150 lbs	8"	12-1/4"	1-pcs	8+ Tip	18.5	B
NEW	ECS-C-701M	M	MF	7'0"	15-30 lbs	13"	14-1/4"	1-pcs	9+ Tip	19.3	C
ECS CUSTOM TROLLING RODS (ROLLER STRIPPER AND ROLLER TIP)											
NEW	ECS-T-641MH	MH	MF/F	6'4"	30-80 lbs	10-1/2"	14-1/4"	1-pcs	7+ Tip	23.4	D
NEW	ECS-T-601H	XH	MF/F	6'0"	50-150 lbs	12-1/4"	14-1/4"	2-pcs	6+ Tip	27.7	D
ECS CUSTOM TROLLING RODS (ALL ROLLER GUIDES)											
NEW	ECS-TR-601H	H	MF/F	6'0"	50-150 lbs	12-1/4"	14-1/4"	2-pcs	5+ Tip	56.0	E
NEW	ECS-TR-601XH	XH	MF/F	6'0"	80-200 lbs	12-1/4"	14-1/4"	2-pcs	5+ Tip	56.4	E

C = Casting Model S = Spinning Model

DTR Custom OFFSHORE RODS

DTR CUSTOM OFFSHORE RODS

- Pure 24-ton carbon blank design on jigging and popping models
- 24-ton carbon and e-glass mixed blank on trolling rods
- 3K-woven carbon fiber outer blank wrap improves hoop strength
- UFR-II: Ultimate Flex Reinforcement rod tip technology
- ALPS deep press 316-graded SS frames with Zirconium inserts (Trolling)
- ALPS aluminum roller tips with 316-graded SS rollers on trolling models
- Fuji K-concept frames with Alconite inserts on jigging and popping models
- MH trolling model features ALPS aluminum reel seat and graphite butt section
- H/XH/XXH Trolling/Deep drop rods feature ALPS aluminum bent butts
- All rods feature machined aluminum, gun smoke anodized gimbals
- Extremely durable tapered TPE foregrips on all models
- DTR Custom Offshore rods are backed by a 3-year limited warranty

MODEL	PWR	TAPER	LENGTH (FT)	LINE WT (LBS)	LURE WT. (OZ)	FOREGRIP LENGTH	REARGRIP LENGTH	SECTIONS	GUIDES	WEIGHT (OZ)	HANDLE
DTR CUSTOM OFFSHORE RODS											
DTR-C-601H	H	MF/F	6'0"	50 - 150 lbs	-	12"	21-3/4"	1-pcs	7 + Tip	33.2	E
DTR-C-601XH	XH	MF/F	6'0"	80 - 200 lbs	-	12"	24-3/4"	1-pcs	7 + Tip	34.4	E
DTR-C-661XXH	XXH	MF/F	6'6"	80 - 250 lbs	-	12"	17"	1-pcs	8 + Tip	46.5	E
DTR-C-581XXH	XXH	MF	5'8"	80 - 200 lbs	120 - 270 gr	8"	12"	1-pcs	8 + Tip	13.1	B
DTR-S-761XH	XH	MF/F	7'6"	60 - 100 lbs	2 - 10 oz	7-1/2"	16-1/2"	1-pcs	6 + Tip	16.2	A
DTR CUSTOM OFFSHORE TROLLING RODS											
DTR-C-601H-F	H	MF/F	6'0"	50 - 150 lbs	-	12-1/4"	14-1/4"	2-pcs	7+Tip	53.9	D
DTR-C-601XH-F	XH	MF/F	6'0"	80 - 200 lbs	-	12-1/4"	14-1/4"	2-pcs	7+Tip	55.1	D
DTR-C-641MH	MH	MF/F	6'4"	30 - 100 lbs	-	10-1/2"	14-1/4"	1-pcs	8 + Tip	24.4	C

C = Casting Model S = Spinning Model



A TPE fore and rear grips with aluminum gimbal and reel seat

B TPE fore and rear grips with aluminum gimbal and trigger reel seat

C TPE foregrip, graphite butt section with aluminum gimbal and reel seat

D Neptune aluminum folding butt with TPE foregrip

E TPE foregrip with ALPS aluminum bent butt



A Rear cork split grip with skeleton spinning reel seat

B Rear cork split grip with skeleton trigger reel seat

C Rear full cork grip with skeleton spinning reel seat

DTR Custom INSHORE RODS

DTR CUSTOM INSHORE RODS

- Technique specific blanks built specifically for Louisiana inshore fishing
- Light and responsive 24/30-ton, low resin carbon rod blanks
- UFR-II: Ultimate Flex Reinforced rod tip technology
- SeaGuide XO and XQ series angled 316 stainless steel guide frames
- Zirconium inserts offer compatibility for both braid and mono
- Customized Fuji skeleton reel seat with woven carbon insert
- Cork tapered full or split grip configuration depending on model
- All models feature a precision placed stainless steel hook keeper
- DTR Custom Inshore rods are backed by a 1-year limited warranty

MODEL	PWR	TAPER	LENGTH (FT)	LINE WT (LBS)	LURE WT. (OZ)	FOREGRIP LENGTH	REARGRIP LENGTH	SECTIONS	GUIDES	WEIGHT (OZ)	HANDLE
DTR CUSTOM INSHORE RODS											
DTR-S-701M-PC	M	F	7'0"	8 - 14 lbs	1/8oz-3/8oz	1-1/2"	10"	1-pcs	7 + Tip	3.4	C
DTR-S-701MH-CR	MH	F	7'0"	8 - 20 lbs	1/4oz-3/4oz	3/4"	10"	1-pcs	7 + Tip	3.6	A
DTR-S-701M-SSB	M	MF	7'0"	8 - 14 lbs	1/4oz-1/2oz	3/4"	10"	1-pcs	7 + Tip	3.8	A
DTR-S-701M-TW	M	M	7'0"	8 - 14 lbs	1/4oz-1/2oz	3/4"	10"	1-pcs	7 + Tip	3.4	A
DTR-S-721ML-JJ	ML	F	7'2"	6 - 12 lbs	1/8oz-5/8oz	3/4"	10-1/2"	1-pcs	8 + Tip	3.8	A
DTR-S-721M-JJ	M	F	7'2"	8 - 14 lbs	1/8oz-5/8oz	3/4"	10-1/2"	1-pcs	8 + Tip	3.8	A
DTR-C-701M-SSB	M	M	7'0"	8 - 14 lbs	1/4oz-1/2oz	3/4"	9-1/4"	1-pcs	9 + Tip	3.4	B
DTR-C-701M-TW	M	M	7'0"	8 - 14 lbs	1/4oz-1/2oz	3/4"	9-1/4"	1-pcs	9 + Tip	3.6	B
DTR-C-701MH-CR	MH	F	7'0"	8 - 20 lbs	1/4oz-3/4oz	3/4"	9-1/4"	1-pcs	9 + Tip	3.8	B
DTR-C-721ML-JJ	ML	F	7'2"	6 - 12 lbs	1/8oz-5/8oz	3/4"	9-1/4"	1-pcs	9 + Tip	3.4	B
DTR-C-721M-JJ	M	F	7'2"	8 - 14 lbs	1/8oz-5/8oz	3/4"	9-1/4"	1-pcs	9 + Tip	3.6	B

C = Casting Model S = Spinning Model



SILVER SLAYER

SILVER SLAYER TARPON RODS

- Specifically designed rod blanks for Tarpon fishing
- Powerful and responsive 24-ton carbon rod blanks
- UFRII: Ultimate Flex Reinforced rod tip technology
- Fuji K-Concept deep press frames help reduce tangles
- Silky smooth performance from Fuji FazLite guide inserts
- SeaGuide double locking Alien reel seat
- Tapered cork fore and rear grip with rubber cork inlay
- Premium Fuji gimbal for support fighting big fish
- Silver Slayer rods are backed by a Limited Lifetime warranty

MODEL	PWR	TAPER	LENGTH (FT)	LINE WT (LBS)	LURE WT. (OZ)	FOREGRIP LENGTH	REARGRIP LENGTH	SECTIONS	GUIDES	WEIGHT (OZ)	HANDLE
SILVER SLAYER TARPON RODS											
SLAY-S-701H-FG	H	MF	7'0"	15-30 lbs	1/2-2 oz	7"	12"	1-pcs	7+ Tip	A	
SLAY-S-701XH-FG	XH	MF	7'0"	20-50 lbs	3/4-3 oz	7"	12"	1-pcs	7+ Tip	A	
SLAY-S-791H-FG	H	MF	7'9"	15-30 lbs	1/2-2 oz	7"	13-1/2"	1-pcs	7+ Tip	A	
SLAY-S-791XH-FG	XH	MF	7'9"	20-50 lbs	3/4-3 oz	7"	13-1/2"	1-pcs	7+ Tip	A	

S = Spinning Model



A Full tapered cork butt with Fuji gimbal and spinning reel seat

SRT INSHORE ELITE RODS

- Fast and responsive 30-ton carbon inshore rod blanks
- UFRII: Ultimate Flex Reinforced rod tip technology
- Tapered cork fore and rear grip with rubber cork inlay
- Fuji premium TVS slotted reel seat for maximum performance
- Fuji K-Concept deep press frames help reduce tangles
- Silky smooth performance from Fuji FazLite guide inserts
- SeaGuide Stainless steel, double legged Trapezoid hook keeper
- SRT Inshore Elite rods are backed by a limited lifetime warranty

MODEL	PWR	TAPER	LENGTH (FT)	LINE WT (LBS)	LURE WT. (OZ)	FOREGRIP LENGTH	REARGRIP LENGTH	SECTIONS	GUIDES	WEIGHT (OZ)	HANDLE
SRT INSHORE ELITE RODS											
SRTE-S-701M-FG	M	MF	7'0"	8-17 lbs	3/8-1 oz	2-1/2"	8"	1-pcs	8+ Tip	5.2	A
SRTE-S-701MH-FG	MH	MF	7'0"	10-20 lbs	1/2-1-1/2 oz	2-1/2"	9"	1-pcs	8+ Tip	5.4	A
SRTE-S-701H-FG	H	MF	7'0"	15-30 lbs	1/2-2 oz	3"	10"	1-pcs	8+ Tip	5.8	A
SRTE-S-761ML-FG	ML	MF	7'6"	6-17 lbs	1/4-1/2 oz	2-3/4"	8"	1-pcs	9+ Tip	5	A
SRTE-S-761M-FG	M	MF	7'6"	8-17 lbs	1/4-3/4 oz	2-3/4"	10"	1-pcs	9+ Tip	5.4	A
SRTE-S-761MH-FG	MH	MF	7'6"	10-20 lbs	1/2-1-1/2 oz	2-3/4"	10"	1-pcs	9+ Tip	5.6	A
SRTE-S-761H-FG	H	MF	7'6"	15-30 lbs	1/2-2-1/2 oz	3"	10"	1-pcs	9+ Tip	6	A

S = Spinning Model

SRT INSHORE PREMIER RODS

- Fast and responsive 30-ton carbon inshore rod blanks
- UFRII: Ultimate Flex Reinforced rod tip technology
- Tapered cork fore and rear grip with rubber cork inlay
- Rear split grip configuration helps reduce weight
- Fuji DPS reel seat for maximum reliability
- SeaGuide deep press 316-grade stainless steel frames
- SeaGuide Zirconium guide inserts for maximum performance
- SeaGuide Stainless steel, double legged Trapezoid hook keeper
- SRT Inshore Premier rods are backed by a 1-year limited warranty

MODEL	PWR	TAPER	LENGTH (FT)	LINE WT (LBS)	LURE WT. (OZ)	FOREGRIP LENGTH	REARGRIP LENGTH	SECTIONS	GUIDES	WEIGHT (OZ)	HANDLE
SRT INSHORE PREMIER RODS											
SRTP-S-701M	M	MF	7'0"	8-17 lbs	3/8-1 oz	2-1/2"	8"	1-pcs	8+ Tip	5	A
SRTP-S-701MH	MH	MF	7'0"	10-20 lbs	1/2-1-1/2 oz	2-1/2"	9"	1-pcs	8+ Tip	5.2	A
SRTP-S-701H	H	MF	7'0"	15-30 lbs	1/2-2 oz	3"	10"	1-pcs	8+ Tip	5.6	A
SRTP-S-761ML	ML	MF	7'6"	6-17 lbs	1/4-1/2 oz	2-3/4"	8"	1-pcs	9+ Tip	5	A
SRTP-S-761M	M	MF	7'6"	8-17 lbs	1/4-3/4 oz	2-3/4"	10"	1-pcs	9+ Tip	5.2	A
SRTP-S-761MH	MH	MF	7'6"	10-20 lbs	1/2-1-1/2 oz	2-3/4"	10"	1-pcs	9+ Tip	5.4	A
SRTP-S-761H	H	MF	7'6"	15-30 lbs	1/2-2-1/2 oz	3"	10"	1-pcs	9+ Tip	5.8	A

S = Spinning Model

SRT Inshore Elite



A Tapered full cork grips with Fuji TVS reel seat

SRT Inshore Premier



A Cork split rear grip with Fuji DPS reel seat

RTF INSHORE

RTF INSHORE RODS

- Technique specific blanks built specifically for Texas inshore fishing
- Light and responsive 24/30-ton, low resin carbon rod blanks
- UFR-II: Ultimate Flex Reinforced rod tip on Croaker models
- SeaGuide XO and XQ series angled 316 stainless steel guide frames
- Zirconium inserts offer compatibility for both braid and mono
- Customized Sea Guide skeleton reel seat with woven carbon
- Tapered cork full or split grip configuration depending on model
- All models feature a precision placed stainless steel hook keeper
- RTF Inshore rods are backed by a 1-year limited warranty
- CR = Croaker Models

MODEL	PWR	TAPER	LENGTH (FT)	LINE WT (LBS)	LURE WT. (OZ)	FOREGRIP LENGTH	REARGRIP LENGTH	SECTIONS	GUIDES	WEIGHT (OZ)	HANDLE
RTF INSHORE RODS											
RTF-C-691ML	ML	MF	6'9"	6-12 lbs	1/8-1/2 oz	3/4"	8"	1-pcs	8+ Tip	3.5	A
RTF-C-691M	M	MF/F	6'9"	6-12 lbs	1/4-3/4 oz	3/4"	8"	1-pcs	8+ Tip	3.8	A
RTF-C-701ML-MF	ML	MF	7'0"	6-12 lbs	1/8-1/2 oz	3/4"	9"	1-pcs	9+ Tip	3.8	A
RTF-C-701M	M	MF	7'0"	6-12 lbs	1/4-3/4 oz	3/4"	9"	1-pcs	8+ Tip	4.2	A
RTF-C-701MH	MH	MF	7'0"	8-17 lbs	1/4-3/4 oz	3/4"	9"	1-pcs	8+ Tip	4.2	A
RTF-C-761MH	MH	MF	7'0"	8-17 lbs	1/4-3/4 oz	1"	9"	1-pcs	9+ Tip	4.2	A
RTF-C-701M-CR	M	MF	7'0"	8-17 lbs	1/4-3/4 oz	2"	9-1/2"	1-pcs	9+ Tip	4.5	B
RTF-S-761M-CR	M	MF	7'6"	8-17 lbs	1/4-3/4 oz	2"	10-1/2"	1-pcs	8+ Tip	4.8	C

C = Casting Model S = Spinning Model



A Rear cork split grip with skeleton trigger reel seat
B Full cork grip with skeleton trigger reel seat
C Full cork grip with skeleton spinning reel seat



A EVA fore and rear grips with nylon gimbal and pipe reel seat
B Graphite butt and EVA fore grip with nylon gimbal and pipe reel seat

SARASOTA

SARASOTA RODS

- 24-ton carbon or E-glass blank depending on model
- UFR-II: Ultimate Flex Reinforcement rod tip technology
- Spin & Cast rods with SeaGuide frames and Zirconium inserts
- Trolling models featuring HD series guide frames
- Durable nylon rod butt on most models. Spinning is EVA
- All models feature durable ABS rod gimbals
- Sarasota rods are backed by a 1-year limited warranty

MODEL	PWR	TAPER	LENGTH (FT)	LINE WT (LBS)	FOREGRIP LENGTH	REARGRIP LENGTH	SECTIONS	GUIDES	WEIGHT (OZ)	HANDLE
SARASOTA RODS										
NEW SR-S-701MHa	MH	MF	7'0"	20-50 lbs	9"	14-1/2"	1-pcs	6+Tip	10.1	A
NEW SR-S-701Ha	H	MF	7'0"	30-65 lbs	9"	14-1/2"	1-pcs	6+Tip	10.6	A
NEW SR-C-701Ma	M	MF	7'0"	15-30 lbs	9"	14-1/4"	1-pcs	9+Tip	18.5	B
NEW SR-C-701MHa	MH	MF	7'0"	20-50 lbs	9"	14"	1-pcs	8+Tip	13.2	B
NEW SR-C-701Ha	H	MF	7'0"	30-65 lbs	9"	14"	1-pcs	8+Tip	13.9	B
SARASOTA TROLLING RODS										
NEW SR-T-641MHa	MH	MF	6'4"	30-80 lbs	10-1/2"	14-1/4"	1-pcs	8+Tip	20.2	B
NEW SR-T-601Ha	H	MF	6'0"	40-100 lb	12-1/4"	14-1/4"	1-pcs	7+Tip	22.2	B
NEW SR-T-601XHa	XH	MF	6'0"	50-150 lbs	12-1/4"	14-1/4"	1-pcs	7+Tip	24.2	B

C = Casting Model S = Spinning Model

EPIXOR

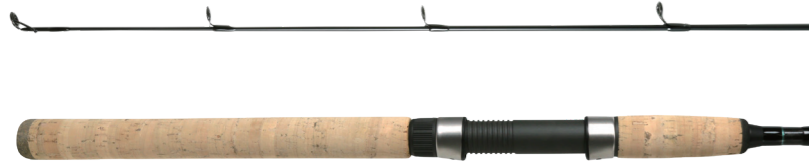

A Full cork fore and rear grips with pipe reel seat

EPIXOR RODS

- Lightweight and responsive 24-ton carbon rod blanks
- Deep press stainless steel frames with Titanium oxide inserts
- Stainless steel hooded pipe reel seat for durability
- Durable and comfortable cork fore and rear grips on all models
- Features a stainless-steel hook keeper on all rod models
- EPIXOR rods are backed by a 1-year limited warranty

MODEL	PWR	TAPER	LENGTH (FT)	LINE WT (LBS)	LURE WT.	FOREGRIP LENGTH	REARGRIP LENGTH	SECTIONS	GUIDES	WEIGHT (OZ)	HANDLE
EPIXOR RODS											
EPI-S-701H	H	MF	7'0"	15-30 lbs	1/2 - 2 oz	3"	10"	1-pcs	7 + Tip	4.2	A
EPI-S-701ML	ML	MF	7'0"	6-10 lbs	1/4 - 1/2 oz	2-1/4"	9"	1-pcs	7 + Tip	4.6	A
EPI-S-701M	M	MF	7'0"	8-12 lbs	3/8 - 3/4 oz	2-1/4"	9"	1-pcs	7 + Tip	4.8	A
EPI-S-701MH	MH	MF	7'0"	12-15 lbs	3/8 - 1 oz	2-1/4"	9"	1-pcs	7 + Tip	6.1	A
EPI-S-761ML	ML	MF	7'6"	6-10 lbs	1/4 - 1/2 oz	2-1/4"	9-3/4"	1-pcs	7 + Tip	4.3	A
EPI-S-761M	M	MF	7'6"	8-12 lbs	3/8 - 3/4 oz	2-1/4"	9-3/4"	1-pcs	7 + Tip	4.9	A
EPI-S-761MH	MH	MF	7'6"	12-15 lbs	3/8 - 1 oz	2-1/4"	9-3/4"	1-pcs	7 + Tip	5.1	A
EPI-S-761H	H	MF	7'6"	15-30 lbs	1/2 - 2-1/2 oz	3"	10-1/2"	1-pcs	8 + Tip	5.8	A

S = Spinning Model

Ceymar INSHORE RODS



A Full Neo cork fore and rear grips with trigger reel seat



B Full Neo cork fore and rear grips with pipe reel seat

CEYMAR INSHORE RODS

- Lightweight and responsive 24-ton carbon rod blanks
- UFR: Ultimate Flex Reinforced rod tip technology
- Stainless steel guides with titanium oxide inserts
- Neo cork full rear grip and fore grip design
- Stainless steel hook keeper on all models
- Ceymar Inshore rods are backed by a 1-year limited warranty

MODEL	PWR	TAPER	LENGTH (FT)	LINE WT (LBS)	LURE WT. (OZ)	FOREGRIP LENGTH	REARGRIP LENGTH	SECTIONS	GUIDES	WEIGHT (OZ)	HANDLE
CEYMAR INSHORE RODS											
CMR-S-701ML	ML	MF	7'0"	6-12 lbs	1/4 - 1/2 oz	2-1/2"	9"	1-pcs	7 + Tip	4.6	B
CMR-S-701M	M	MF	7'0"	8 - 12 lbs	3/8 - 3/4 oz	2-1/2"	9"	1-pcs	7 + Tip	5.0	B
CMR-S-701MH	MH	MF	7'0"	12-15 lbs	3/8 - 1 oz	2-1/2"	9"	1-pcs	7 + Tip	5.1	B
CMR-C-661M	M	MF	6'6"	8-12 lbs	3/8 - 3/4 oz	2-1/4"	9"	1-pcs	9 + Tip	4.7	A
CMR-C-701MH	MH	MF	7'0"	12-15 lbs	3/8 - 1 oz	3-1/2"	10"	1-pcs	9 + Tip	5.3	A

C = Casting Model S = Spinning Model

AXEON PRO RODS

- All models feature UFR tip technology
- Boat rods feature durable E-glass rod blanks
- Swimbait and Inshore feature composite rod blanks
- EVA foam fore and rear grips on all models
- Boat rods feature stainless steel welded guides
- Swimbait and Inshore rods feature titanium oxide guide inserts
- Axeon Pro rods are backed by a limited 1-year warranty

MODEL	PWR	TAPER	LENGTH (FT)	LINE WT (LBS)	LURE WT. (OZ)	FOREGRIP LENGTH	REARGRIP LENGTH	SECTIONS	GUIDES	WEIGHT (OZ)	HANDLE
AXEON PRO RODS											
AXP-S-701M	M	MF	7'0"	15 - 30 lbs	—	9-1/2"	13-1/2"	1-pcs	7 + Tip	7.6	A
AXP-S-701MH	MH	MF	7'0"	20 - 40 lbs	—	9-1/2"	13-1/2"	1-pcs	7 + Tip	8.0	A
AXP-C-701M	M	MF	7'0"	15 - 30 lbs	—	9-1/2"	13-1/2"	1-pcs	8 + Tip	7.0	A
AXP-C-701MH	MH	MF	7'0"	20 - 40 lbs	—	9-1/2"	13-1/2"	1-pcs	8 + Tip	7.3	A
AXP-C-701H	H	MF	7'0"	30 - 50 lbs	—	9-1/2"	13-1/2"	1-pcs	8 + Tip	8.0	A
AXP-C-701XH	XH	MF	7'0"	40 - 60 lbs	—	9-1/2"	13-1/2"	1-pcs	8 + Tip	8.0	A
AXPi-C-801XH	XH	MF/F	8'0"	20 - 40 lbs	1-1/2 - 4-1/2	3-1/2"	14-1/4"	1-pcs	10 + Tip	8.0	B
AXPSB-C-7111XH	XH	F	7'11"	15 - 40 lbs	2 - 10	3-1/2"	14-1/4"	1-pcs	10 + Tip	8.0	B

C = Casting Model S = Spinning Model

AXEON PRO



A EVA fore and rear grips



B EVA fore and rear grip with trigger reel seat

CORTEZ SABIKI RODS

- 24-ton carbon blank construction
- Specially designed bait rods for use with Sabiki's rigs
- Internal blank design allows hooks to travel in the blank
- Design allows anglers to re-use Sabiki bait catching rigs
- Custom rounded tip prevents hooks from catching
- Durable, non-slip rubber shrink tube grips
- Non-skid, rubber gimbals on all models
- Cushioned stainless steel hooded reel seat
- 2-pcs blank design butted in handle for transportation
- Cortez rods are backed by a 1-year limited warranty

MODEL	PWR	TAPER	LENGTH (FT)	LINE WT (LBS)	FOREGRIP LENGTH	REARGRIP LENGTH	SECTIONS	GUIDES	WEIGHT (OZ)	HANDLE
CORTEZ SABIKI RODS										
CZ-C-732SBK	M	M	7'3"	15 - 30 lbs	4-3/4"	11"	2-pcs	1 + Tip	13.4	A
CZ-S-732SBK	M	M	7'3"	15 - 30 lbs	4-3/4"	11"	2-pcs	1 + Tip	14.1	A

C = Casting Model S = Spinning Model

CORTEZ



A Detachable butt section with shrink tube fore and rear grips

Battle Cat



A Cork butt with EVA foregrip

BATTLE CAT RODS

- Extremely durable E-glass rod blank construction
- EVA fore grip for comfort while fighting big Cats
- Cork butt section reduces binding while fishing in rod holders
- Double foot welded stainless steel guides for ultimate durability
- Heavy duty stainless steel hook keeper
- Graphite pipe reel seat with oversized anodized aluminum hoods
- Durable non-skid, rubber gimbal on all models
- 2-pcs blank construction, butted in handle for 1-pcs strength and feel
- 2-pcs blank design also offers easy transportation
- Fluorescent wrapped indicator tip for improved visibility at night
- Battle Cat rods are backed by a limited lifetime warranty

MODEL	PWR	TAPER	LENGTH (FT)	LINE WT (LBS)	LURE WT. (OZ)	FOREGRIP LENGTH	REARGRIP LENGTH	SECTIONS	GUIDES	WEIGHT (OZ)	HANDLE
BATTLE CAT RODS											
BC-C-762H	H	MF	7'6"	15-60lbs	1-8oz	6"	13"	2-pcs	9 + Tip	17.0	A
BC-C-802H	H	MF	8'0"	15-60lbs	1-8oz	6"	13"	2-pcs	9 + Tip	17.4	A
BC-S-762H	H	MF	7'6"	15-60lbs	1-8oz	6"	13"	2-pcs	7 + Tip	16.8	A
BC-S-802H	H	MF	8'0"	15-60lbs	1-8oz	6"	13"	2-pcs	8 + Tip	16.8	A
BC-S-1002H	H	MF	10'0"	15-60lbs	1-8oz	8-5/8"	16"	2-pcs	9 + Tip	19.7	A

C = Casting Model S = Spinning Model

CRAB SNARE SPECIAL



A Cork tape fore and rear grip with pipe reel seat

CRAB SNARE SPECIAL RODS

- Specifically designed for Crab Snaring
- Sensitive graphite composite blank
- Aluminum oxide guide inserts
- Double foot stainless steel guide frames
- Cork wrapped nonslip fore and rear grips
- Soft-touch EVA cushions above and below reel seat
- Crab Snaring rods are backed by a limited 1-year warranty

MODEL	PWR	TAPER	LENGTH (FT)	LINE WT (LBS)	LURE WT. (OZ)	FOREGRIP LENGTH	REARGRIP LENGTH	SECTIONS	GUIDES	WEIGHT (OZ)	HANDLE
CRAB SNARE SPECIAL RODS											
CSS-S-1102H	ML	F	11'0"	20-40 lbs	3-8 oz	7-1/2"	25"	2-pcs	6 + Tip	10.5	A

S = Spinning Model



A TPE/Compressed cork rear split grip with pipe reel seat

B Non slip rubber grips above and below handle with stainless steel butt

C Full TPE tapered rear and foregrip with pipe reel seat

D Non-slip rubber grips above and below reel seat with stainless steel butt

Hawaiian Custom

HAWAIIAN CUSTOM RODS

- Split butt design to reduce weight and improve balance
- Features ALPS-316 grade stainless steel guide frames
- Zirconium guide inserts for braided or monofilament lines
- Specialized TPE foam material on fore and rear grip for durability
- All rods feature a 3K metal woven material for custom look
- Hawaiian Custom rods are backed by a 1-year limited warranty

MODEL	PWR	TAPER	LENGTH (FT)	LINE WT (LBS)	LURE WT. (OZ)	FOREGRIP LENGTH	REARGRIP LENGTH	SECTIONS	GUIDES	WEIGHT (OZ)	HANDLE
HAWAIIAN CUSTOM WHIPPING RODS											
HWA-S-862MHa	MH	M/MF	8'6"	10-20 lbs	3/8-1/2 oz	3"	12"	2-pcs	8 + Tip	6.5	A
HWA-S-902Ma	M	M/MF	9'0"	8-17 lbs	3/8-1 oz	3"	13"	2-pcs	9 + Tip	6.7	A
HWA-S-902MHa	MH	M/MF	9'0"	10-20 lbs	3/8-1/2 oz	3"	13"	2-pcs	9 + Tip	6.9	A
HWA-S-1402MHa	MH	M/MF	14'0"	12-25 lbs	1/2-1-3/4 oz	5"	21-1/2"	2-pcs	13 + Tip	16.0	A
HAWAIIAN CUSTOM SPECIAL EDITION WHIPPING RODS											
HWA-S-902Ma-LE	M	M/MF	9'0"	8-17 lbs	3/8-1 oz	3"	13"	2-pcs	9 + Tip	6.5	A
HWA-S-902MHa-LE	MH	M/MF	9'0"	10-20 lbs	3/8-1/2 oz	3"	13"	2-pcs	9 + Tip	6.7	A
HAWAIIAN CUSTOM MENPACHI RODS											
HWM-S-1072MHa	MH	M/MF	10'7"	8-20 lbs	1/2-2 oz	4"	16"	2-pcs	10 + Tip	9.6	A
HWM-S-1202MHa	MH	M/MF	12'0"	8-20 lbs	1/2-2oz	4"	18-1/2"	2-pcs	11 + Tip	11.6	A
HWM-S-1302MHa	MH	M/MF	13'0"	8-20lbs	1/2-2 oz	4"	18-1/2"	2-pcs	12 + Tip	11.8	A
HAWAIIAN CUSTOM SHORELINE PLUGGER RODS											
HSP-S-962Ma	M	MF	9'6"	30-65 lbs	30-160 gr	5-1/2"	20"	2-pcs	8 + Tip	11.3	C
HAWAIIAN CUSTOM ULUA RODS											
HWU-C-1302MHa	MH	MF	13'0"	50-60 lbs	7-10 oz	6-3/4"	36-1/2"	2-pcs	7 + Tip	29.9	B
HWU-C-1302Ha	H	MF	13'0"	50-60 lbs	9-12 oz	6-3/4"	36-1/2"	2-pcs	7 + Tip	36.1	B
HWU-C-1302MHb	MH	MF	13'0"	50-60 lbs	7-10 oz	6-3/4"	36-1/2"	2-pcs	7 + Tip	29.7	D
HWU-C-1302Hb	H	MF	13'0"	50-80 lbs	9-12 oz	6-3/4"	36-1/2"	2-pcs	7 + Tip	37.6	D

C = Casting Model S = Spinning Model

hawaiian custom

POPPING/JIGGING RODS

HAWAIIAN CUSTOM POPPING RODS

- Light and responsive 24/30-Ton, low resin carbon rod blanks
- 70/30 rod blank design, 2-pcs construction butted in foregrip
- Premium Fuji reel seat for maximum reliability
- Fuji K-concept double foot guide frames, help reduce tangles
- Fuji Alconite guide inserts for abrasion resistance
- Oversized guide sizing allows for improved knot clearance while casting
- 2-pcs blank aides in transportation, but offers max power, based on ferrule location
- Tapered TPE foregrip with TPE rear split grips for reduced weight and balance
- Hawaiian Custom Popping rods are backed by a 1-year limited warranty

HAWAIIAN CUSTOM JIGGING RODS

- Light and responsive 24-Ton, low resin rod blanks
- Fuji K-concept guide frames, help reduce tangles
- Fuji Alconite guide inserts for abrasion resistance
- Fuji screw down reel seat with no exposed threads
- Custom designed hard EVA floating foregrip
- Tapered TPE rear split grip for reduced weight and balance
- Hawaiian Custom Jigging rods are backed by a 1-year limited warranty

MODEL	PWR	TAPER	LENGTH (FT)	LINE WT (LBS)	LURE WT. (OZ)	FOREGRIP LENGTH	REARGRIP LENGTH	SECTIONS	GUIDES	WEIGHT (OZ)	HANDLE
HAWAIIAN CUSTOM POPPING RODS											
HWP-S-832MHa	MH	M/MF	8'3"	30-65 lbs	30-160 gr	6-1/2"	18"	2-pcs	6+ Tip	13.5	A
HWP-S-832Ha	H	M/MF	8'3"	50-100 lbs	90-200 gr	5-1/2"	18"	2-pcs	6+ Tip	14.4	A
HAWAIIAN CUSTOM SLOW JIGGING RODS											
HCSJ-C-631M	M	M	6'3"	PE: 3-4	60 - 120 gr	4"	16-1/4"	1-pcs	8+ Tip	6.0	B
HCSJ-C-631MH	MH	M	6'3"	PE: 4-5	100-160 gr	4"	16-1/4"	1-pcs	8+ Tip	6.8	B
HCSJ-C-631H	H	M	6'3"	PE: 4-5	120-250 gr	4"	16-1/4"	1-pcs	8+ Tip	7.4	B
HCSJ-S-631M	M	M	6'3"	PE: 3-4	60 - 120 gr	4-1/4"	16-1/4"	1-pcs	6+ Tip	6.0	C
HCSJ-S-631MH	MH	M	6'3"	PE: 4-5	100-160 gr	4-1/4"	16-1/4"	1-pcs	6+ Tip	6.8	C
HCSJ-S-631H	H	M	6'3"	PE: 4-5	120-250 gr	4-1/4"	16-1/4"	1-pcs	6+ Tip	7.8	C
HAWAII CUSTOM TUNA TROLLING RODS											
HCS-TRB-581-50	—	MF/F	5'8"	50-lbs	—	10"	21.5"	2-pcs	3 rollers + Swivel Tip	40.6	D
HCS-TRB-591-80	—	MF/F	5'9"	80-lbs	—	10"	21.5"	2-pcs	3 rollers + Swivel Tip	48.0	D

C = Casting Model S = Spinning Model TRB = Trolling Model



A TPE/Compressed cork rear split grip with Fuji pipe reel seat

B TPE split rear grip with TPE screwdown foregrip and Fuji trigger reel seat

C TPE split rear grip with TPE screwdown foregrip and Fuji pipe reel seat

D EVA foregrip with ALPS aluminum bent butt



A Non-slip shrink tube grips above and below Fuji carbon reel seat



HCS CUSTOM

SURF RODS

HCS CUSTOM SURF RODS

- Fast and responsive 30-ton carbon surf rod blanks
- 3-pcs blank configuration for easy transportation
- Custom carbon fiber pipe with Fuji reel seat hoods
- Fuji 3-legged, deep pressed Low Rider guide frames
- Fuji's Alconite inserts for hardness and abrasion resistance
- Counter balancing weight system in rear butt cap
- Non slip shrink tube grips above and below reel seat
- Ergonomic EVA tapered rear grip for leverage while casting
- HCS Custom Surf are backed by a limited lifetime warranty

MODEL	PWR	TAPER	LENGTH (FT)	LINE WT (LBS)	LURE WT. (OZ)	FOREGRIP LENGTH	REARGRIP LENGTH	SECTIONS	GUIDES	WEIGHT (OZ)	HANDLE
HCS CUSTOM SURF RODS											
HCS-S-1333XH	XH	MF	13'3"	20 - 50 lbs	120 - 250 gr	5-1/2"	26-1/2"	3-pcs	5+ Tip	18.8	A
HCS-S-1423XH	XH	MF	14'2"	20 - 50 lbs	120 - 250 gr	5-1/2"	26-1/2"	3-pcs	6+ Tip	20.6	A

C = Casting Model S = Spinning Model



LEDROS Surf CSX

LEDROS SURF RODS

- 30-Ton carbon, ultra-sensitive and responsive blank construction
- ALPS stainless steel double footed guide frames for increased distance
- ALPS blazing Zirconium guide inserts
- Pac Bay reel seats with blue anodized hoods and rings
- Non slip rubber shrink tube handle with tapered rear grip
- Tip over butt ferrule connection for maximum strength and durability
- Machined tapered hood transitions above and below reel seat
- Low profile butt cap design for unobstructed fishing
- All Cedros Surf rods are 2-pcs blank construction
- Cedros Surf CSX rods are backed by a limited lifetime warranty

MODEL	PWR	TAPER	LENGTH (FT)	LINE WT (LBS)	LURE WT. (OZ)	FOREGRIP LENGTH	REARGRIP LENGTH	SECTIONS	GUIDES	WEIGHT (OZ)	HANDLE
CEDROS SURF RODS											
CSX-S-902MH	MH	MF	9' 0"	20-50 lbs	2-4	7-1/4"	19"	2-pcs	6 + Tip	10.2	A
CSX-S-1002M	M	MF	10' 0"	14-40 lbs	1-1/2-3	7-1/4"	19"	2-pcs	7 + Tip	10.9	A
CSX-S-1002MH	MH	MF	10' 0"	20-50 lbs	2-5	7-1/4"	19"	2-pcs	7 + Tip	11.1	A
CSX-S-1002H	H	MF	10' 0"	30-65 lbs	3-8	7-1/4"	19"	2-pcs	7 + Tip	11.7	A
CSX-S-1062M	M	MF	10' 6"	20-50 lbs	2-4	8"	19-3/4"	2-pcs	7 + Tip	11.8	A
CSX-S-1102MH	MH	MF	11' 0"	30-50 lbs	2-5	8-1/2"	23-3/4"	2-pcs	7 + Tip	12.7	A

C = Casting Model S = Spinning Model



A Rubber shrink tube handle with Pac Bay pipe reel seat

ROCKAWAY SURF HD RODS

- Light and responsive 24/30-ton, low resin carbon rod blanks
- UFR-II: Ultimate Flex Reinforced rod tip technology
- Tip over butt ferrule connection for improved balance and feel
- 70/30 blank configuration allows improved loading for casting
- SeaGuide XQH series angled 316 stainless steel guide frames
- Zirconium inserts offer compatibility for both braid and mono
- Okuma double locking reel seat with stainless steel hoods
- Minimal grip design with textured shrink tube fore and rear grip
- Rockaway HD Surf rods are backed by a 1-year limited warranty

MODEL	PWR	TAPER	LENGTH (FT)	LINE WT (LBS)	LURE WT. (OZ)	FOREGRIP LENGTH	REARGRIP LENGTH	SECTIONS	GUIDES	WEIGHT (OZ)	HANDLE
ROCKAWAY SURF HD RODS											
RHD-S-902M	M	MF/F	9' 0"	10-20 lbs	1-4 oz	5-1/4"	18-3/4"	2-pcs	6 + Tip	9.0	A
RHD-S-962MH	MH	MF/F	9' 6"	12-25 lbs	2-6 oz	5-1/4"	18-3/4"	2-pcs	6 + Tip	10.4	A
RHD-S-1062M	M	MF/F	10' 6"	10-20 lbs	1-4 oz	5-1/4"	18-3/4"	2-pcs	7 + Tip	11.0	A
RHD-S-1062MH	MH	MF/F	10' 6"	12-25 lbs	2-6 lbs	5-1/4"	18-3/4"	2-pcs	7 + Tip	11.6	A
RHD-S-1102MH	MH	MF/F	11' 0"	15-40 lbs	3-8 oz	5-1/4"	18-3/4"	2-pcs	7 + Tip	12.6	A
RHD-S-1202H	H	MF/F	12' 0"	20-60 lbs	6-16 oz	5-1/4"	18-3/4"	2-pcs	7 + Tip	15.2	A

S = Spinning Model

ROCKAWAY SURF RODS

- Extremely lightweight and responsive 24-ton carbon rod blanks
- UFR-II: Ultimate Flex Reinforcement rod tip technology
- Tip over butt ferrule connection for improved balance
- XQ series angled Sea Guide 316-Stainless steel frames
- Zirconium inserts offer compatibility for both braid and mono
- Tapered shrink tube grips for non-slip surface and durability
- Rounded EVA butt cap for improved leverage while casting
- Rockaway surf rods are backed by a 1-year limited warranty

MODEL	PWR	TAPER	LENGTH (FT)	LINE WT (LBS)	LURE WT. (OZ)	FOREGRIP LENGTH	REARGRIP LENGTH	SECTIONS	GUIDES	WEIGHT (OZ)	HANDLE
ROCKAWAY SURF RODS											
RA-S-802M	M	MF	8' 0"	10-17 lbs	1/2 - 1-1/2 oz	5-1/2"	19"	2-pcs	5 + Tip	7.5	A
RA-S-802MH	MH	MF	8' 0"	12-20 lbs	3/4 - 2 oz	5-1/2"	19"	2-pcs	5 + Tip	7.4	A
RA-S-902M	M	MF	9' 0"	10-17 lbs	1/2 - 1-1/2 oz	5-1/2"	19"	2-pcs	5 + Tip	8.1	A
RA-S-902MH	MH	MF	9' 0"	12-20 lbs	3/4 - 2 oz	5-1/2"	19"	2-pcs	5 + Tip	8.2	A
RA-S-1002ML	ML	MF	10' 0"	8-17 lbs	1/2-2 oz	5-1/2"	21"	2-pcs	6 + Tip	8.9	A
RA-S-1002M	M	MF	10' 0"	10-20 lbs	3/4-3 oz	5-1/2"	21"	2-pcs	6 + Tip	9.1	A
RA-S-1002MH	MH	M	10' 0"	12-25 lbs	1-4 oz	5-1/2"	21"	2-pcs	6 + Tip	9.2	A
RA-S-1102ML	ML	MF	11' 0"	8-17 lbs	1/2-2 oz	5-1/2"	21"	2-pcs	6 + Tip	9.8	A
RA-S-1102M	M	MF	11' 0"	10-20 lbs	3/4-3 oz	5-1/2"	21"	2-pcs	6 + Tip	10.6	A
RA-S-1202M	M	MF	12' 0"	10-20 lbs	3/4-3 oz	5-1/2"	21"	2-pcs	6 + Tip	11.0	A
RA-S-1202MH	MH	M	12' 0"	12-25 lbs	1-4 oz	5-1/2"	21"	2-pcs	6 + Tip	11.6	A

S = Spinning Model

ROCKAWAY SURF HD RODS



A Non slip X-pattern shrink tube grips with double locking reel seat

ROCKAWAY



A Shrink and EVA fore and rear grips with pipe reel seat



ROCKAWAY

SURF SP RODS

ROCKAWAY SURF SP RODS

- Light and responsive 24/30-ton carbon rod blanks
- Tip over butt ferrule connection for improved balance and feel
- SeaGuide XQ series angled 316 stainless steel guide frames
- Zirconium inserts offer compatibility for both braid and mono
- SeaGuide Stainless steel, double legged Trapezoid hook keeper
- Minimal EVA split grip design for reduced weight and balance
- Rockaway SP Surf rods are backed by a 1-year limited warranty

MODEL	PWR	TAPER	LENGTH (FT)	LINE WT (LBS)	LURE WT. (OZ)	FOREGRIP LENGTH	REARGRIP LENGTH	SECTIONS	GUIDES	WEIGHT (OZ)	HANDLE
ROCKAWAY SURF SP RODS											
RSP-S-862ML	ML	MF	8'6"	6-12 lbs	3/16 - 1/2 oz	0"	12-1/2"	2-pcs	7 + Tip	4.0	A
RSP-S-862M	M	MF	8'6"	8-17 lbs	1/4 - 5/8 oz	0"	12-1/2"	2-pcs	7 + Tip	4.4	A
NEW RSP-S-1002M+	M+	MF	10'0"	10-20 lbs	1/2 - 3 oz	0"	19-1/2"	2-pcs	9 + Tip	5.8	A
NEW RSP-S-1102M+	M+	MF	11'0"	10-20 lbs	1/2 - 3 oz	0"	19-1/2"	2-pcs	9 + Tip	7.6	A

S = Spinning Model



A Minimal grip design with EVA rear grip and spinning reel seat



A Full cork tape fore and rear grip with pipe reel seat



SOLARIS SURF

SOLARIS SURF RODS

- Light and responsive 24-ton, low resin carbon rod blanks
- UFRII: Ultimate Flex Reinforced rod tip technology
- Tip over butt ferrule connection for improved balance and feel
- 70/30 blank configuration allows improved loading for casting
- SeaGuide XQH series angled 316 stainless steel guide frames
- Aluminum oxide inserts offer compatibility for both braid and mono
- Stainless steel hooded reel seat for maximum durability
- Cork wrapped non-slip fore and rear grips
- Solaris Surf rods are backed by a 1-year limited warranty

MODEL	PWR	TAPER	LENGTH (FT)	LINE WT (LBS)	LURE WT. (OZ)	FOREGRIP LENGTH	REARGRIP LENGTH	SECTIONS	GUIDES	WEIGHT (OZ)	HANDLE
SOLARIS SURF RODS											
SSX-S-902M	M	MF/F	9'0"	10-20 lbs	1-4 oz	6-1/4"	19"	2-pcs	6 + Tip	11.0	A
SSX-S-962MH	MH	MF/F	9'6"	12-25 lbs	2-6 oz	6-1/4"	21"	2-pcs	6 + Tip	12.2	A
SSX-S-1062M	M	MF/F	10'6"	10-20 lbs	1-4 oz	6-1/4"	21"	2-pcs	7 + Tip	13.4	A
SSX-S-1062MH	MH	MF/F	10'6"	12-25 lbs	2-6 oz	6-1/4"	21"	2-pcs	7 + Tip	15.0	A
SSX-S-1102MH	MH	MF/F	11'0"	15-40 lbs	3-8 oz	6-1/4"	23"	2-pcs	7 + Tip	15.7	A
SSX-S-1202H	H	MF/F	12'0"	20-60 lbs	6-16 oz	6-1/4"	25"	2-pcs	7 + Tip	19.5	A

S = Spinning Model

NESIKA



A Split EVA rear and foregrip with pipe reel seat

NESIKA SURF RODS

- Extremely lightweight and responsive 24-ton carbon rod blanks
- UFR-II: Ultimate Flex Reinforced rod tip technology
- Tip over butt ferrule connection for improved strength
- Stainless steel deep press guide frames for durability
- Titanium oxide guide inserts for reduced abrasion
- Comfortable EVA fore and rear split grip configuration
- Nesika Surf rods are backed by a 1-year limited warranty

MODEL	PWR	TAPER	LENGTH (FT)	LINE WT (LBS)	LURE WT. (OZ)	FOREGRIP LENGTH	REARGRIP LENGTH	SECTIONS	GUIDES	WEIGHT (OZ)	HANDLE
NESIKA SURF RODS											
NSK-S-902M	M	MF	9'0"	10-17 lbs	1/2-1-1/2 oz	5-1/2"	19"	2-pcs	5 + Tip	7.0	A
NSK-S-902MH	MH	MF	9'0"	12-20 lbs	3/4-2 oz	5-1/2"	19"	2-pcs	5 + Tip	7.4	A
NSK-S-1002M	M	MF	10'0"	10-20 lbs	3/4-3 oz	5-1/2"	21"	2-pcs	6 + Tip	8.3	A
NSK-S-1002MH	MH	MF	10'0"	12-25 lbs	1-4 oz	5-1/2"	21"	2-pcs	6 + Tip	8.4	A
NSK-S-1202M	M	MF	12'0"	10-20 lbs	3/4-3 oz	5-1/2"	21"	2-pcs	6 + Tip	10.5	A
NSK-S-1202MH	MH	MF	12'0"	12-25 lbs	1-4 oz	5-1/2"	21"	2-pcs	6 + Tip	11.2	A

S = Spinning Model

LONGITUDE SURF RODS

- Sensitive graphite composite blank
- Aluminum oxide guide inserts
- Double footed stainless steel guide frames
- Stainless steel hooded reel seats
- Cork wrapped non slip fore and rear grips
- Soft-touch EVA cushions above and below reel seat
- Pac Bay rubber butt cap
- Longitude Surf rods are backed by a limited 1-year warranty

MODEL	PWR	TAPER	LENGTH (FT)	LINE WT (LBS)	LURE WT. (OZ)	FOREGRIP LENGTH	REARGRIP LENGTH	SECTIONS	GUIDES	WEIGHT (OZ)	HANDLE
LONGITUDE SURF RODS											
LC-C-902H-1	H	MF/F	9'0"	15-40 lbs	1-4	7"	19-1/4"	2-pcs	6 + Tip	14.8	A
LC-C-1202H-1	H	F	12'0"	20-40 lbs	3-8	9-1/2"	25-1/2"	2-pcs	6 + Tip	28.8	A
LC-S-802M-1	M	MF	8'0"	15-30 lbs	1/2-3	5-1/8"	17-1/4"	2-pcs	5 + Tip	10.8	A
LC-S-902H-1	H	MF/F	9'0"	15-40 lbs	3-6	7"	19-1/4"	2-pcs	6 + Tip	18.0	A
LC-S-1002H-1	H	F	10'0"	20-40 lbs	3-8	7-1/8"	22-1/8"	2-pcs	6 + Tip	21.6	A
LC-S-1102H-1	H	F	11'0"	20-40 lbs	3-8	7-1/2"	25"	2-pcs	6 + Tip	26.8	A
LC-S-1202H-1	H	F	12'0"	20-40 lbs	3-8	9-1/2"	25-1/2"	2-pcs	6 + Tip	30.6	A

C = Casting Model S = Spinning Model

LONGITUDE



A Cork tape handle

TUNDRA RODS

- Durable glass fiber rod blank construction
- 2-pcs blank construction on 7-to 12-ft. models
- 3 pcs blank construction on 13-and 15-ft. models
- Reinforced double footed guide on all models
- 13- and 15-ft. rods feature a fold down stripper guide
- Comfortable EVA foam fore and rear grips
- 13- and 15-ft. rods feature a split butt grip configuration
- Durable rubber butt cap
- Tundra rods are backed by a 1-year limited warranty

MODEL	PWR	TAPER	LENGTH (FT)	LINE WT (LBS)	LURE WT. (OZ)	FOREGRIP LENGTH	REARGRIP LENGTH	SECTIONS	GUIDES	WEIGHT (OZ)	HANDLE
TUNDRA RODS											
TU-70	M	M/MF	7'0"	3-7 lbs	1/4-3/4	3-3/4"	11-3/4"	2-pcs	4 + Tip	9.5	A
TU-80	M	M/MF	8'0"	5-9 lbs	1/2-1-1/2	4"	14-3/4"	2-pcs	5 + Tip	10.8	A
TU-100	MH	M/MF	10'0"	5-11.5 lbs	3/4-2-1/2	4"	16-1/2"	2-pcs	5 + Tip	20.8	A
TU-120	MH	M/MF	12'0"	5-14 lbs	1-5	4"	16-1/2"	2-pcs	6 + Tip	27.1	A
TU-130	MH	M/MF	13'0"	5-14 lbs	2-6	4-1/4"	21-3/4"	3-pcs	4 + Tip	31.8	A
TU-150	MH	M/MF	15'0"	5-14 lbs	2-8	4-1/2"	22-1/4"	3-pcs	5 + Tip	41.5	A

TUNDRA



A Full EVA fore and rear grips with pipe reel seat

TUNDRA PRO RODS

- Durable and sensitive graphite composite rod blank
- Comfortable EVA fore and rear grip configuration
- Multi-disc oil felt drag washers
- Features a 3 ball bearing drive system
- Machined aluminum, 2-tone anodized spool
- All Tundra pro guides feature double foot construction
- Tip over butt ferrule connection for improved feel
- All Tundra Pro rods feature 2-pcs blanks for transportation
- Tundra Pro rods are backed by a 1-year limited warranty

MODEL	PWR	TAPER	LENGTH (FT)	LINE WT (LBS)	LURE WT. (OZ)	FOREGRIP LENGTH	REARGRIP LENGTH	SECTIONS	GUIDES	WEIGHT (OZ)	HANDLE
TUNDRA PRO RODS											
TXP-S-702M	M	MF	7'0"	10-20 lbs	1/2-2	3-3/4"	11-3/4"	2-pcs	4 + Tip	7.7	A
TXP-S-802M	M	MF	8'0"	10-25 lbs	3/4-2-1/2	4"	14-3/4"	2-pcs	5 + Tip	8.6	A
TXP-S-902MH	MH	MF	9'0"	15-30 lbs	1-4	4"	15-3/4"	2-pcs	5 + Tip	11.9	A
TXP-S-1002MH	MH	MF	10'0"	20-40 lbs	2-6	4"	16-1/2"	2-pcs	5 + Tip	16.7	A
TXP-S-1202MH	MH	MF	12'0"	20-40 lbs	2-6	6-3/4"	16-1/2"	2-pcs	6 + Tip	22.4	A
TXP-S-1503MH	MH	MF	15'0"	20-40 lbs	2-8	4-1/4"	21-3/4"	3-pcs	6 + Tip	31.4	A

S = Spinning Model

TUNDRA PRO



A Shrink and EVA fore and rear grips with pipe reel seat

Cold Water Ice



COLD WATER ICE COMBOS

- 1-pcs 24-ton carbon rod blank construction
- Split grip with cork and EVA design
- Custom reel seat allows improved sensitivity
- FG = non reel seat for customizing reel placement
- Stainless steel guide frames and inserts
- Backed by a limited 1-year warranty

MODEL	PWR	LENGTH	REEL MODEL	BEARINGS	LINE CAPACITY	SECTIONS	PRE-SPOOLED WITH LINE
COLD WATER ICE COMBOS							
CWI-S-271MLa-C10	ML	27"	C-10	6BB+1RB	210/2, 110/4, 70/6	1-pcs	No
CWI-S-301Ma-C10	M	30"	C-10	6BB+1RB	210/2, 110/4, 70/6	1-pcs	No
CWI-S-321Ma-C10	M	32"	C-10	6BB+1RB	210/2, 110/4, 70/6	1-pcs	No

S = Spinning Model

Cold Water DEADSTICK COMBO



COLD WATER DEADSTICK COMBOS

- 1-pcs 24-ton carbon rod blank construction
- Ceymar micro baitfeeder series spinning reel
- 7BB + 1RB bearing system for smoothness
- Multi-disc, oiled felt drag system
- 2-toned, machined aluminum spool
- FG = non reel seat for customizing reel placement
- Stainless steel guide frames and inserts
- Backed by a limited 1-year warranty

MODEL	PWR	LENGTH	REEL MODEL	BEARINGS	LINE CAPACITY	SECTIONS	PRE-SPOOLED WITH LINE
COLD WATER DEADSTICK COMBOS							
CDS-S-301MLFG-CBF1000	ML	30"	CBF-1000	7BB+1RB	280/2, 140/4, 100/6	1-pcs	No
CDS-S-301MFG-CBF1000	M	30"	CBF-1000	7BB+1RB	280/2, 140/4, 100/6	1-pcs	No

S = Spinning Model

TRIO PRO ICE

TRIO PRO ICE RODS

- 2-pcs blank design for transportation
- 3-different tip power sections with one grip
- Flat tip blanks allow for maximum sensitivity
- Premium cork and carbon grip configuration
- Colored rod tips to improve bite visibility
- Stainless steel guide frames and inserts
- PVC travel bag holds all 3 rods and handle
- Backed by a limited 1-year warranty



MODEL	PWR	TAPER	LENGTH	FOREGRIP LENGTH	REARGRIP LENGTH	SECTIONS	GUIDES	WEIGHT (OZ)	HANDLE
TRIO PRO ICE KIT									
TRP-S-ICE-1	UL, L, ML	MF	24", 26", 28"	3/4"	1-1/2"	2-pcs	5+ Tip	2.6	A

S = Spinning Model

A Trio Pro Ice: Cork and carbon rear grip with cork/EVA foregrip

TRIO ICE

TRIO ICE RODS

- 2-pcs blank design for transportation
- 3-different tip power sections with one grip
- Tubular glass rod blank for maximum durability
- Premium cork fore and rear grip configuration
- Colored rod tips to improve bite visibility
- Stainless steel guide frames and inserts
- Backed by a limited 1-year warranty

MODEL	PWR	TAPER	LENGTH	FOREGRIP LENGTH	REARGRIP LENGTH	SECTIONS	GUIDES	WEIGHT (OZ)	HANDLE
TRIO ICE KIT									
TR-S-ICE-1	UL, L, ML	MF	24", 26", 28"	3/4"	1-1/2"	2-pcs	5+ Tip	2.2	A

S = Spinning Model

A Trio Ice: Cork and EVA fore and rear grips



ICX

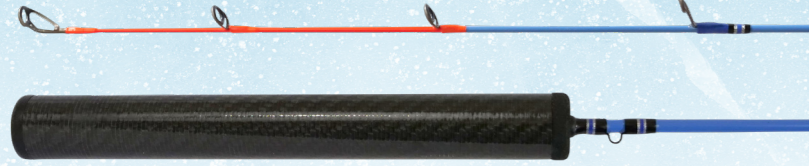

A Full carbon fiber grip, no reel seat

ICX ICE RODS

- 1-pcs 24-ton carbon rod blank construction
- Custom 3K woven carbon fiber grip design
- FG = non reel seat for customizing reel placement
- Orange colored rod tip for improved bite visibility
- Fuji FazLite: Rugged inserts with smooth as silk performance
- Fuji K-concept frame design improves performance
- Backed by a limited 1-year warranty

MODEL	PWR	TAPER	LENGTH	FOREGRIP LENGTH	REARGRIP LENGTH	SECTIONS	GUIDES	WEIGHT (OZ)	HANDLE
ICX ICE RODS									
ICx-S-301ML-FG	ML	F	30"	0"	6-1/2"	1-pcs	5 + Tip	1.6	A
ICx-S-321M-FG	M	F	32"	0"	6-1/2"	1-pcs	5 + Tip	1.6	A
ICx-S-361MH-FG	MH	F	36"	0"	7-3/4"	1-pcs	5 + Tip	2.1	A
ICx-S-401MH-FG	MH	F	40"	0"	7-3/4"	1-pcs	5 + Tip	1.9	A

S = Spinning Model

Inspira Ice

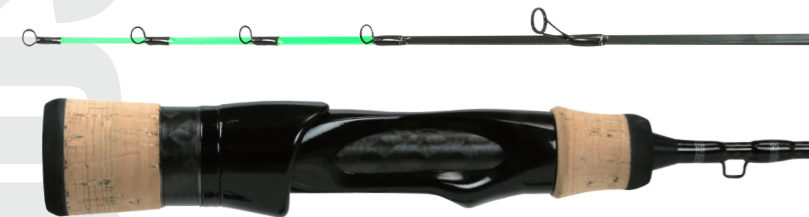

A Cork and carbon rear grip with cork/EVA foregrip

INSPIRA ICE RODS

- 1-pcs flat tip blank allows maximum sensitivity
- Premium cork and carbon grip configuration
- Colored rod tips to improve bite visibility
- Stainless steel guide frames and inserts
- Backed by a limited 1-year warranty

MODEL	PWR	TAPER	LENGTH	FOREGRIP LENGTH	REARGRIP LENGTH	SECTIONS	GUIDES	WEIGHT (OZ)	HANDLE
INSPIRA ICE RODS									
ISXI-S-241UL	UL	MF	24"	3/4"	1-1/2"	1-pcs	5 + Tip	1.9	A
ISXI-S-261L	L	MF	26"	3/4"	1-1/2"	1-pcs	5 + Tip	1.9	A
ISXI-S-281ML	ML	MF	28"	3/4"	1-1/2"	1-pcs	5 + Tip	1.9	A

S = Spinning Model

COLD WATER ICE RODS

- 1-pcs 24-ton carbon rod blank construction
- Split grip with cork and EVA design
- Custom reel seat allows improved sensitivity
- FG = non reel seat for customizing reel placement
- Stainless steel guide frames and inserts
- Backed by a limited 1-year warranty

MODEL	PWR	TAPER	LENGTH	FOREGRIP LENGTH	REARGRIP LENGTH	SECTIONS	GUIDES	WEIGHT (OZ)	HANDLE
COLD WATER ICE RODS									
CWI-S-241UL	UL	F	24"	1"	4-1/4"	1-pcs	3 + Tip	1.6	A
CWI-S-251L	L	F	25"	1"	4-1/4"	1-pcs	3 + Tip	1.3	A
CWI-S-271La	L	F	27"	1"	4-1/4"	1-pcs	3 + Tip	1.3	A
CWI-S-271ML	ML	F	27"	1"	4-1/4"	1-pcs	3 + Tip	1.6	A
CWI-S-271MLa	ML	F	27"	1"	4-1/4"	1-pcs	3 + Tip	1.6	A
CWI-S-301MLa	ML	F	30"	1"	5-1/2"	1-pcs	3 + Tip	1.6	A
CWI-S-301Ma	M	F	30"	1"	5-1/2"	1-pcs	3 + Tip	1.6	A
CWI-S-321Ma	M	F	32"	1"	5-1/2"	1-pcs	4 + Tip	1.6	A
CWI-S-321M-FG	M	F	32"	0"	7-3/4"	1-pcs	4 + Tip	1.4	B
CWI-S-361MH-FG	MH	F	36"	0"	7-3/4"	1-pcs	4 + Tip	2.1	B
CWI-S-401MH-FG	MH	F	40"	0"	7-3/4"	1-pcs	4 + Tip	1.9	B

S = Spinning Model

COLD WATER DEADSTICK RODS

- 1-pcs 24-ton carbon rod blank construction
- Full premium cork grip design with carbon inlay
- FG = non reel seat for customizing reel placement
- Multi-colored rod tip for improved bite visibility
- Stainless steel guide frames and inserts
- Backed by a limited 1-year warranty

MODEL	PWR	TAPER	LENGTH	FOREGRIP LENGTH	REARGRIP LENGTH	SECTIONS	GUIDES	WEIGHT (OZ)	HANDLE
COLD WATER DEADSTICK RODS									
CDS-S-301ML-FG	ML	F	30"	0"	7-3/4"	1-pcs	4 + Tip	1.6	A
CDS-S-301M-FG	M	F	30"	0"	7-3/4"	1-pcs	4 + Tip	1.6	A

S = Spinning Model

Cold Water Ice



A Cork and EVA split grip with custom exposed blank reel seat



B Full cork grip with carbon insert, no reel seat

Cold Water Deadstick



A Full cork grip with carbon insert, no reel seat



TRAVEL

Nothing inspires the senses like getting out & traveling to a new destination & fishing new waters. The thrill of discovery fills us all. Whether you are hiking to a high mountain lake to chase beautiful golden trout, tying on a big swimbait to try to catch a giant striped bass, or dropping back a live sardine in hopes of breaking the triple digit mark on a yellowfin tuna, Okuma has your travel gear needs covered. Our travel gear is designed to not only help you get to your hidden destination, but to land that fish of a lifetime.

VOYAGER Signature

VOYAGER SIGNATURE SURF RODS

- Light and responsive 24-ton carbon rod blanks
- UFRIL: Ultimate Flex Reinforced rod tip technology
- Fuji Tangle Free guide frames with FazLite inserts
- Fuji DPS reel seat design for maximum reliability
- 4-pcs blank construction with spigot ferrule connections
- Non-slip shrink tube and EVA fore and rear grips
- Protective rod tube for use in transportation
- Voyager Signature rods are backed by a 1-year limited warranty

VOYAGER SIGNATURE BOAT RODS

- Light and responsive 24-ton carbon rod blanks
- UFRIL: Ultimate Flex Reinforced rod tip technology
- Fuji Tangle Free guide frames with FazLite inserts
- Fuji DPS reel seat and gimbal for maximum reliability
- 3-pcs blank construction with spigot ferrule connections
- Rod comes with two different powered rod tips
- Tapered TPE fore and rear grips for comfort and durability
- Protective travel bag for both storage and transportation
- Voyager Signature rods are backed by a 1-year limited warranty

MODEL	PWR	TAPER	LENGTH (FT)	LINE WT (LBS)	LURE WT. (OZ)	FOREGRIP LENGTH	REARGRIP LENGTH	SECTIONS	GUIDES	WEIGHT (OZ)	HANDLE
VOYAGER SIGNATURE SURF RODS											
VSS-S-904M	M	MF	9'0"	10 - 25 lbs	3/4 - 2 oz	7-1/2"	19"	4-pcs	5 + Tip	10.9	A
VSS-S-1004MH	MH	MF	10'0"	15 - 30 lbs	1 - 4 oz	7-1/2"	19"	4-pcs	5 + Tip	12.2	A
VSS-S-1004H	H	MF	10'0"	17 - 40 lbs	2 - 6 oz	7-1/2"	19"	4-pcs	5 + Tip	13.9	A
VOYAGER SIGNATURE BOAT RODS											
VSB-C-663M-MH	M / MH	MF	6'6"	30- 60 lbs	—	8"	12-1/4"	3-pcs	6 + Tip	12.8	B
VSB-C-703ML-M	L / ML	MF	7'0"	15 - 40 lbs	—	8"	12-1/4"	3-pcs	7 + Tip	12.2	B
VSB-C-703M-MH	M / MH	MF	7'0"	30- 60 lbs	—	8"	12-1/4"	3-pcs	7 + Tip	15.2	B
VSB-S-703ML-M	L / ML	MF	7'0"	15 - 40 lbs	—	8"	12-1/4"	3-pcs	5 + Tip	13.1	B
VSB-S-703M-MH	M / MH	MF	7'0"	30- 60 lbs	—	8"	12-1/4"	3-pcs	5 + Tip	16.0	B

C = Casting Model S = Spinning Model



A Voyager Signature Surf Rods: Shrink tube rear grip with rubber cap and Fuji pipe reel seat

B Voyager Signature Boat Rod: Tapered TPE foam with Fuji gimbal and Fuji pipe reel seat



A Split cork rear grip with Fuji spinning reel seat

B Split cork rear grip with Fuji trigger reel seat

VOYAGER Signature

VOYAGER SIGNATURE FRESHWATER RODS

- Light and responsive 30/40-ton low resin carbon blanks
- Sea Guide XO/XQ 316-SS angled guide frames reduce line twists
- Zirconium inserts offer compatibility for both braid and mono
- Fuji reel seat for reduced weight and improved feel
- Custom machined aluminum screw down reel seat hood
- 4-pcs blank construction with spigot ferrule connections
- Premium tapered cork split grip design for reduced weight
- Protective travel bag for both storage and transportation
- Voyager Signature rods are backed by a 1-year limited warranty

MODEL	PWR	TAPER	LENGTH (FT)	LINE WT (LBS)	LURE WT. (OZ)	FOREGRIP LENGTH	REARGRIP LENGTH	SECTIONS	GUIDES	WEIGHT (OZ)	HANDLE
VOYAGER SIGNATURE FRESHWATER RODS											
VSS-S-724ML	ML	MF/F	7'2"	6 - 12 lbs	1/8 - 3/8	0"	9-3/4"	4-pcs	8 + Tip	4.8	A
VSS-S-724M	M	MF/F	7'2"	8 - 17 lbs	1/4 - 5/8 oz	0"	9-3/4"	4-pcs	8 + Tip	5.0	A
VSS-C-724M	M	MF/F	7'2"	8 - 17 lbs	1/4 - 5/8 oz	0"	10-1/2"	4-pcs	9 + Tip	5.4	B
VSS-C-724MH	MH	MF/F	7'2"	10 - 20 lbs	3/8 - 1 oz	0"	10-1/2"	4-pcs	9 + Tip	5.8	B
VSS-C-754H	H	MF/F	7'5"	12 - 25 lbs	5/8 - 1-1/2 oz	0"	11-1/2"	4-pcs	9 + Tip	6.2	B

C = Casting Model S = Spinning Model



SST "A" TRAVEL

SST "A" TRAVEL RODS

- Technique and species-specific rod actions
- Light and responsive 24/30-ton low resin carbon blanks
- 3 or 4 pcs blank construction depending on model
- Deep press guide frames for added durability
- Zirconium inserts offer compatibility for both braid and mono
- Premium cork fore and rear grip with rubber cork accents
- CG models feature woven carbon fore and rear grips
- Precision placed stainless steel hook keeper on all models
- Stainless steel hook keepers on all cork rod models
- Travel rods come packed in a protective SST rod tube
- SST rods are backed by a 1-year limited warranty

MODEL	PWR	TAPER	LENGTH (FT)	LINE WT (LBS)	LURE WT. (OZ)	FOREGRIP LENGTH	REARGRIP LENGTH	SECTIONS	GUIDES	WEIGHT (OZ)	HANDLE
SST "A" TRAVEL RODS											
SST-S-663La	L	M/MF	6'6"	2-8 lbs	1/8 - 3/8 oz	2"	7-3/4"	3-pcs	6 + Tip	4.0	A
SST-S-763MHa	MH	MF	7'6"	10-20 lbs	3/8 - 1-1/2 oz	2-1/2"	11"	3-pcs	7 + Tip	5.6	A
SST-S-863MHa	MH	MF	8'6"	10-25 lbs	3/8 - 1-1/2 oz	2-1/2"	11"	3-pcs	8 + Tip	6.1	A
SST-S-1064Ma	M	MF	10'6"	8-17 lbs	3/8 - 3/4	2-1/2"	11"	4-pcs	11 + Tip	7.4	A
SST-S-704M-CGa	M	MF	7'0"	8-17 lbs	1/4 - 5/8 oz	2-1/2"	8-3/4"	4-pcs	7 + Tip	6.1	B

S = Spinning Model



A Full cork butt section with pipe reel seat



B Full carbon butt section with pipe reel seat



VOYAGER

VOYAGER TRAVEL KIT

- Convenient nylon travel bag
- Shock-resistant foam insert
- Adjustable shoulder strap
- 6'0" travel rod in ML action
- Travel rod breaks down into 5-pcs
- Spinning reel features 1BB
- Spinning reel capacity: 170/4, 110/6, 80/8
- Stainless steel hooded reel seat
- Machined aluminum, anodized spinning spool

MODEL	PWR	LENGTH (FT)	REEL MODEL	BEARINGS	LINE CAPACITY	SECTIONS	PRE-SPOOLED WITH LINE
VOYAGER TRAVEL KIT							
VS-605-20	ML	6'0"	VS-20FT	1BB	170/4, 100/6, 80/8	5-pcs	No



FLY & FLOAT

United by single action, 1:1 retrieve ratios, Fly and Float products highlight two very distinct strengths of Okuma Fishing Tackle. The first is the ability of our advanced CNC machining facility in Taiwan. From the same precision factory that makes Makaira offshore reels, comes our machined fly and float reels. The second is our commitment to value in our die-cast aluminum product lines. The Sierra fly reel changed the industry that used words like "traditional" to sell consumers grossly overpriced reels. Sierra redefined value in the fly fishing market, and SLV "b" products build upon that foundation. In both areas of strength, you can find bigger names, but not better product.



Helios SX

HELIOS SX FLY REELS

- Machined aluminum and anodized frame and spool design
- Multi-disk Japanese felt drag washers provide incredible smoothness
- Hydro Block watertight drag seal protects the drag system
- 2BB + 1RB stainless steel bearing drive system
- Easy-to-change left to right hand retrieval conversion
- Helios SX fly reels are backed by a limited lifetime warranty

MODEL	BEARINGS	WEIGHT (OZ.)	LINE RETRIEVE	SPOOL WIDTH	SPOOL DIAM.	LINE CAPACITY	FRAME/SPOOL
HELIOS SX FLY REELS							
HSX-4/5	2BB + 1RB	5.4 oz	9.6"	—	—	WF4F + 110-yds / 20-lbs	4.6
HSX-5/6	2BB + 1RB	6.1 oz	11.7"	—	—	WF5F + 150-yds / 20-lbs	5.5
HSX-7/8	2BB + 1RB	6.3 oz	12.1"	—	—	WF7F + 200-yds / 20-lbs	6
HSX-8/9	2BB + 1RB	7.0 oz	13.4"	—	—	WF8F + 200-yds / 20-lbs	6.6
HSX-10/11	2BB + 1RB	7.7 oz	15.3"	—	—	WF10F + 200-yds / 30-lbs	7.8



RAWII-1002

RAW-II 1002

RAWII CENTERPIN FLOAT REELS

- Precision 6061-T6 machined aluminum frame and spool
- Durable Type-II, two-tone anodized frame and spool
- 2 premium stainless steel Japanese ball bearings
- Machine cut stainless steel spool shaft
- 1-pcs Machined Rigid Frame construction
- On/Off click ratchet for added spool tension
- Ported spool with exposed rim for easy spool control
- Includes Okuma's protective neoprene reel shield
- RAWII is backed by a 1-year limited warranty

MODEL	BEARINGS	WEIGHT (OZ.)	LINE RETRIEVE	SPOOL WIDTH	SPOOL DIAM.	LINE CAPACITY	FRAME/SPOOL
RAWII CENTERPIN FLOAT REELS							
RAWII-1002	2 BB	8.23	13"	18.5mm	114mm	275 yds / 8 lbs	AL / AL



VT-1002

AVENTA

AVENTA FLOAT REELS

- Precision machined stainless steel spool shafts
- 1-piece Machined Rigid Frame construction
- Machined aluminum anodized spools
- On/Off click ratchet for added spool tension
- Ported spool with exposed rim for easy control
- 2 stainless steel Japanese ball bearings
- AVENTA is backed by a 1-year limited warranty

MODEL	BEARINGS	WEIGHT (OZ.)	LINE RETRIEVE	SPOOL WIDTH	SPOOL DIAM.	LINE CAPACITY	FRAME/SPOOL
AVENTA FLOAT REELS							
VT-1002	2 BB	8.23	13"	18.5mm	114mm	275 yds / 8 lbs	AL / AL

Float fishing is a unique and specific technique. The center-pin crowd is dedicated, knowledgeable and passionate about their sport. They are also extremely discerning about their tackle. The Aventa series is made from solid aluminum bar stock, for precision spool alignment and maximum freespool. The VT-1002, with two stainless steel ball bearings, is excellent for casting directly from the reel or for drag-free drifts.

AVENTA Float Rods

AVENTA FLOAT RODS

- Balanced rod actions for the Aventa reels
- Sensitive graphite blank construction
- Tall frame guides for line control
- Aluminum Oxide guide inserts
- Reel seat or slip ring models
- High quality cork grips
- Aventa Float Rods are backed by a 1-year limited warranty

MODEL	TAPER	LENGTH (FT)	LINE WT (LBS)	LURE WT. (OZ)	FOREGRIP LENGTH	REARGRIP LENGTH	SECTIONS	GUIDES	WEIGHT (OZ)	HANDLE
AVENTA FLOAT RODS										
VT-S-1363FR-2*	M	13'6"	4-8 lbs	1/8-3/8	19-1/4" Total Length		3-pcs	13 + Tip	6.4	A
VT-S-1363FR	M	13'6"	4-8 lbs	1/8-3/8	5-9/10"	8-1/5"	3-pcs	13 + Tip	6.6	B

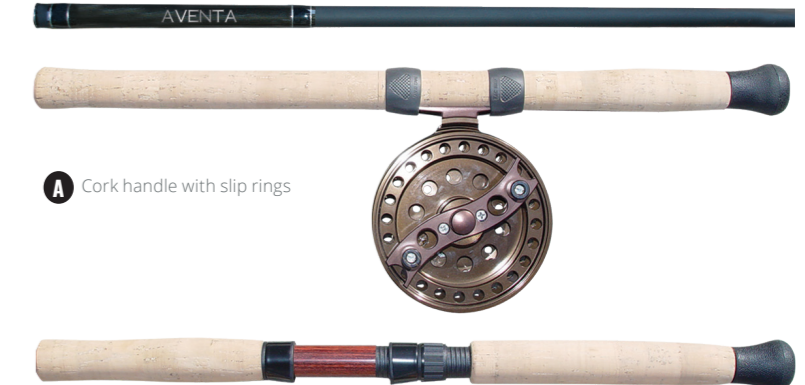

A Cork handle with slip rings

A Cork handle with cherry wood insert on reel seat

SST

SST "A" FLOAT RODS

- Light and responsive 24/30-ton low resin carbon blanks
- 3 pcs blank construction
- Sea Guide deep press guide frames for added durability
- Zirconium inserts offer compatibility for both braid and mono
- Premium cork fore and rear grip
- CG models feature woven carbon fore and rear grips
- Rear seat or slip ring models available
- SST rods are backed by a 1-year limited warranty

MODEL	TAPER	LENGTH (FT)	LINE WT (LBS)	FOREGRIP LENGTH	REARGRIP LENGTH	SECTIONS	GUIDES	WEIGHT (OZ)	HANDLE
SST "A" FLOAT RODS									
SST-S-1343FFa	M	13' 4"	6-12 lbs	20" Total Length		3-pcs	9 + Tip	7.0	B
SST-S-1343FRa	M	13' 4"	6-12 lbs	7-1/2"	9-1/2"	3-pcs	9 + Tip	7.0	A

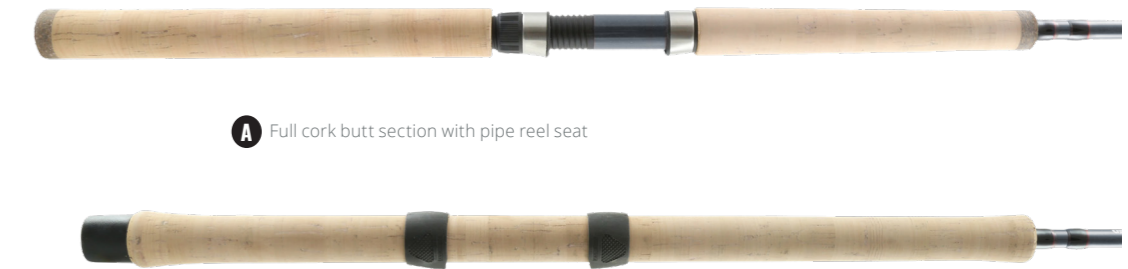

A Full cork butt section with pipe reel seat

B Full cork butt section with slip rings



SLV-56b



SX-5/6



SLV "b" FLY REELS

- Multi-disc cork and stainless steel drag washers
- Roller bearing engages drag system in one direction
- Precision machined stainless steel spool shaft
- ALC: Alumilite diecast aluminum frame design
- Rigid Diecast aluminum, super large arbor spool design
- Precision machine, brass bushing drive
- Easy-to-change left to right hand retrieval conversion

MODEL	BEARINGS	WEIGHT (OZ.)	LINE RETRIEVE	SPOOL WIDTH	SPOOL DIAM.	LINE CAPACITY	FRAME/SPOOL	LINE WT.
SLV "b" FLY REELS								
SLV 23b	1RB	4.5	8"	22mm	66mm	WF-2, 50yds/12lbs	AL / AL	2.3 wt.
SLV 45b	1RB	4.8	9"	24mm	75mm	WF-4, 95yds/12lbs	AL / AL	4.5 wt.
SLV 56b	1RB	5.3	10"	28mm	82mm	WF-5, 140yds/20lbs	AL / AL	5.6 wt.
SLV 78b	1RB	5.5	11"	31mm	88mm	WF-7, 145yds/20lbs	AL / AL	7.8 wt.
SLV 89b	1RB	6.1	12"	34mm	95mm	WF-8, 150yds/30lbs	AL / AL	8.9 wt.
SLV-1011b	1RB	9.7	13"	40mm	114mm	WF-10, 520yds/30lbs	AL / AL	10.11 wt.
SLV "b" SPOOLS								
SLV 23b Spool	1RB	4.5	8"	22mm	66mm	WF-2, 50yds/12lbs	- / AL	2.3 wt.
SLV 45b Spool	1RB	4.8	9"	24mm	75mm	WF-4, 95yds/12lbs	- / AL	4.5 wt.
SLV 56b Spool	1RB	5.3	10"	28mm	82mm	WF-5, 140yds/20lbs	- / AL	5.6 wt.
SLV 78b Spool	1RB	5.5	11"	31mm	88mm	WF-7, 145yds/20lbs	- / AL	7.8 wt.
SLV 89b Spool	1RB	6.1	12"	34mm	95mm	WF-8, 150yds/30lbs	- / AL	8.9 wt.
SLV-1011b Spool	1RB	9.7	13"	40mm	114mm	WF-10, 520yds/30lbs	- / AL	10.11 wt.



SIERRA X FLY REELS

- Multi-disc, composite drag system
- Roller bearing engages drag in one direction
- ALC: Alumilite diecast aluminum frame design
- Rigid diecast aluminum, large arbor spool design
- Easy-to-change left to right hand retrieval conversion
- Sierra-X fly reels are backed by a 1-year limited warranty

MODEL	BEARINGS	WEIGHT (OZ.)	LINE RETRIEVE	SPOOL WIDTH	SPOOL DIAM.	LINE CAPACITY	FRAME/SPOOL	LINE WT.
SIERRA X FLY REELS								
SX-3/4	2BB + 1RB	5.0	6.3"	17mm	70mm	WF-4, 60 yds / 20 lbs	AL / AL	3.4 WT.*
SX-4/5	2BB + 1RB	5.2	6.3"	28mm	75mm	WF-4, 70 yds / 20 lbs	AL / AL	4.5 WT.*
SX-5/6	2BB + 1RB	5.7	7.5"	27.5mm	85mm	WF-5, 100 yds / 20 lbs	AL / AL	5.6 WT.
SX-7/8	2BB + 1RB	6.5	9.1"	27.5mm	95mm	WF-8, 100 yds / 20 lbs	AL / AL	7.8 WT.



SLV FLY RODS

- Balanced rod actions for the Aventa reels
- Sensitive graphite blank construction
- Tall frame guides for line control
- Aluminum Oxide guide inserts
- Reel seat or slip ring models
- High quality cork grips



MODEL	TAPER	LENGTH (FT)	LINE WT	ROD BLANK	REEL SEAT DESCRIPTION	SECTIONS	GUIDES	WEIGHT (OZ)	HANDLE
SLV FLY RODS									
SLV-3-80-4	MF	8'0"	3 wt.	Graphite	AL hoods with carbon fiber pipe	4-pcs	8 + Tip	3.8	A
SLV-4-86-4	MF	8'6"	4 wt.	Graphite	AL hoods with carbon fiber pipe	4-pcs	9 + Tip	4.2	A
SLV-5-90-4	MF	9'0"	5 wt.	Graphite	AL hoods with carbon fiber pipe	4-pcs	9 + Tip	4.8	A
SLV-6-90-4	MF	9'0"	6 wt.	Graphite	AL hoods with carbon fiber pipe	4-pcs	9 + Tip	4.9	A
SLV-7-90-4	MF	9'0"	7 wt.	Graphite	AL hoods with carbon fiber pipe	4-pcs	9 + Tip	5	B
SLV-8-90-4	MF	9'0"	8 wt.	Graphite	AL hoods with carbon fiber pipe	4-pcs	9 + Tip	4.7	B
SLV-8-96-4	MF	9'6"	8 wt.	Graphite	AL hoods with carbon fiber pipe	4-pcs	10 + Tip	5.2	B
SLV-10-90-4	MF	9'0"	10 wt.	Graphite	AL hoods with carbon fiber pipe	4-pcs	9 + Tip	5.4	B



A Cork foregrip, Aluminum pipe reel seat with aluminum hoods



B Cork foregrip, Aluminum pipe reel seat with aluminum hoods with fighting butt

CRISIUM Fly Rods

CRISIUM FLY RODS

- Lightweight graphite construction
- 2-piece rod design
- Titanium Oxide stripper guide
- Stainless steel snake guides
- Rosewood reel seat
- Okuma rod bag included
- Okuma 1-year limited warranty



MODEL	TAPER	LENGTH (FT)	LINE WT	ROD BLANK	REEL SEAT DESCRIPTION	SECTIONS	GUIDES	WEIGHT (OZ)	HANDLE
CRISIUM FLY RODS									
CRF-34-70-2	MF	7'0"	3/4 wt.	Graphite	Rosewood reel seat w/ stainless hoods	2-pcs	6 + Tip	2.8	A
CRF-45-86-2	MF	8'6"	4/5 wt.	Graphite	Rosewood reel seat w/ stainless hoods	2-pcs	9 + Tip	3.6	A
CRF-67-86-2	MF	8'6"	6/7 wt.	Graphite	Rosewood reel seat w/ stainless hoods	2-pcs	9 + Tip	4	A
CRF-56-90-2	M/MF	9'0"	5/6 wt.	Graphite	Rosewood reel seat w/ stainless hoods	2-pcs	9 + Tip	4.2	A
CRF-78-90-2	M/MF	9'0"	7/8 wt.	Graphite	Rosewood reel seat w/ stainless hoods	2-pcs	9 + Tip	4.4	A

A Cork foregrip and Rosewood reel seat with aluminum hoods



COMBOS

A key component of our mission at Okuma Fishing Tackle is to maintain fishing as accessible to all interested people. Part of that effort includes our involvement in numerous conservation & fishing organizations. On the product side, it's our rod & reel combos that receive the focus. Our selection is backed by our commitment to make that first step into fishing an incredibly positive experience. We fill these products with color, excitement in addition to value & performance, because catching the eye is the first step in creating an angler.

Halogen

HALOGEN COMBOS

- Responsive and durable 24-ton carbon rod blanks
- Halogen Spin reels feature a 4BB+1RB drive system
- Halogen Baitcast reels feature a 5BB+1RB drive system
- CFR: Cyclonic Flow Rotor on spinning models
- Premium SeaGuide frames with Zirconium oxide inserts
- External adjustable magnetic cast control: Baitcast models
- Split EVA and TGT Grip: Traction Grip Technology
- Halogen combos are backed by a 1-year limited warranty

MODEL	PWR	LENGTH (FT)	REEL MODEL	BEARINGS	LINE CAPACITY	SECTIONS	NUMBER OF GUIDES
HALOGEN SPINNING COMBOS							
HG-S-661M-3000a	M	6'6"	HG-3000a	4BB+1RB	210/6, 170/8, 140/10	1-pcs	6+ Tip
HG-S-691ML-3000a	MH	6'9"	HG-3000a	4BB+1RB	210/6, 170/8, 140/10	1-pcs	7+ Tip
HG-S-721M-3000a	H	7'2"	HG-3000a	4BB+1RB	210/6, 170/8, 140/10	1-pcs	7+ Tip
HALOGEN BAITCAST COMBOS							
HG-C-721M-100Ha	M / MH	7'2"	HG-100Ha	5BB+1RB	120/12, 110/14, 90/16	1-pcs	9+ Tip
HG-C-721MH-100Ha	L / ML	7'2"	HG-100Ha	5BB+1RB	120/12, 110/14, 90/16	1-pcs	9+ Tip

C = Casting Model S = Spinning Model



AVENGER

AVENGER SPINNING COMBOS

- Responsive and durable 24-ton carbon rod blanks
- UFR: Ultimate Flex Reinforced rod tip technology
- Avenger standard or baitfeeder spinning reel
- Avengers reels feature a 6BB+1RB drive system
- Machined aluminum, 2 tone anodized spool
- All models feature a precision placed stainless steel hook keeper
- Avenger combos are backed by a 1-year limited warranty

AVENGER SALMON/STEELHEAD COMBOS

- Specifically developed for Salmon/Steelhead anglers
- Responsive and durable 24-ton carbon rod blanks
- UFR: Ultimate Flex Reinforced rod tip technology
- Avenger reels feature a 6BB+1RB drive system
- Machined aluminum, 2 tone anodized spool
- Feature a precision placed stainless steel hook keeper
- Avenger combos are backed by a 1-year limited warranty

MODEL	PWR	LENGTH (FT)	REEL MODEL	BEARINGS	LINE CAPACITY	SECTIONS	PRE-SPOOLED WITH LINE
AVENGER BAITFEEDER COMBOS							
AV-BF-701M-4000	M	7'0"	ABF-4000	6BB+1RB	285/8, 230/10, 190/12	1-pcs	No
AV-BF-701MH-6000	MH	7'0"	ABF-6000	6BB+1RB	325/12, 220/16, 180/20	1-pcs	No
AV-BF-701H-8000	H	7'0"	ABF-8000	6BB+1RB	440/12, 300/16, 245/20	1-pcs	No
AVENGER FRESHWATER SPINNING COMBOS							
AV-S-662ML-3000	ML	6'6"	AV-3000	6BB+1RB	240/6, 200/8, 165/10	2-pcs	No
AV-S-702M-3000	M	7'0"	AV-3000	6BB+1RB	240/6, 200/8, 165/10	2-pcs	No
AVENGER INSHORE/FRESHWATER SPINNING COMBOS							
AV-S-701ML-3000	ML	7'0"	AV-3000	6BB+1RB	240/6, 200/8, 165/10	1-pcs	No
AV-S-701M-3000	M	7'0"	AV-3000	6BB+1RB	240/6, 200/8, 165/10	1-pcs	No
AV-S-701MH-4000	MH	7'0"	AV-4000	6BB+1RB	285/8, 230/10, 190/12	1-pcs	No
AVENGER SALMON/STEELHEAD COMBOS							
AV-S-802MH-FG-4000	MH	8'0"	AV-4000	6BB+1RB	265/8, 220/10, 185/12	2-pcs	No
AV-S-862MH-FG-4000	MH	8'6"	AV-4000	6BB+1RB	265/8, 220/10, 185/12	2-pcs	No
AV-S-902MH-FG-4000	MH	9'0"	AV-4000	6BB+1RB	265/8, 220/10, 185/12	2-pcs	No

C = Casting Model S = Spinning Model



DEAD EYE *Classic*

DEAD EYE CLASSIC COMBOS

- Designed specifically for Walleye trolling
- Specially designed E-glass rod blank tapers for trolling
- Telescopic blank design for easier transportation
- Shrink tube foregrip designed for ultimate durability
- Magda Pro line counter reel, measures in feet
- 2 stainless steel ball bearings for max performance
- Dead Eye Classic combos are backed by a 1-year limited warranty

MODEL	PWR	LENGTH (FT)	REEL MODEL	BEARINGS	LINE CAPACITY	SECTIONS	PRE-SPOOLED WITH LINE
DEAD EYE CLASSIC COMBOS							
DEC-7101MT-20DX	M	7'10"	MA-20DX	2BB	290/14, 230/18, 210/20	1-pcs/Tele	No
DEC-861MT-20DX	M	8'6"	MA-20DX	2BB	290/14, 230/18, 210/20	1-pcs/Tele	No



CONVECTOR

CONVECTOR COMBOS

- Developed for Kokanee and Walleye trolling
- Feature Convector 163 or 354 line counter reels
- 2HPB + 1RB stainless steel bearing drive
- Kokanee: Full cork rear/foregrip configuration
- Walleye: Shrink tube rear grip with EVA foregrip
- Kokanee: 2-pcs rod blank construction
- Walleye: 1-pcs telescopic rod blank
- Convector combos backed by a 1-year limited warranty

MODEL	PWR	LENGTH (FT)	REEL MODEL	BEARINGS	LINE CAPACITY	SECTIONS	PRE-SPOOLED WITH LINE
CONVECTOR COMBOS							
CV-C-762L-163D	L	7'6"	CV-163D	2HPB + 1RB	260/8, 180/12, 115/16	2-pcs	No
CV-C-7101MT-354D*	M	7'10"	CV-354D	2HPB + 1RB	250/12, 230/14, 150/20	1-pcs/Tele	No
CV-C-861MT-354D*	M	8'6"	CV-354D	2HPB + 1RB	250/12, 230/14, 150/20	1-pcs/Tele	No

* = Walleye Trolling Models



Celilo

Kokanee Combo

CEILO KOKANEE COMBOS

- Specifically designed for Kokanee trolling
- Sensitive and light graphite composite blanks
- Durable aluminum oxide guide inserts
- Tapered core fore and rear grip configuration
- Magda Pro line counter reel, measures in feet
- 2 stainless steel ball bearings for max performance
- Celilo Kokanee combos are backed by a 1-year limited warranty

MODEL	PWR	LENGTH (FT)	REEL MODEL	BEARINGS	LINE CAPACITY	SECTIONS	PRE-SPOOLED WITH LINE
CEILO KOKANEE COMBOS							
CE-C-561Ha-XP452La	H	5'6"	XP-452La	2BB	580/20, 430/25, 330/30	1-pcs	No
CE-762L-15DX	L	7'6"	MA-15DX	2BB	310/10, 290/12, 240/14	2-pcs	No
CE-802L-15DX	L	8'0"	MA-15DX	2BB	310/10, 290/12, 240/14	2-pcs	No





Great Lakes Trolling Combos

GREAT LAKES TROLLING COMBO

- Specific Great Lakes Trolling rod actions
- Durable E-glass blank construction
- Double footed aluminum oxide guides
- Stainless steel hooded reel seats
- Comfortable EVA foam grips.
- Machine cut brass gearing
- Corrosion resistant graphite spools
- Power handles standard on all models
- Limited 1-year rod warranty

MODEL	PWR	LENGTH (FT)	REEL MODEL	BEARINGS	LINE CAPACITY	SECTIONS	PRE-SPOOLED WITH LINE
GREAT LAKES TROLLING COMBO							
CPDR-862M-300La	M	8'6"	CLX-300L	Bushing	510/15, 420/20, 310/25	2-pcs	No
CP-PB-7101MT-20DXT*	M	7'10"	MA-20DX	2BB	290/14, 230/18, 210/20	1-pcs/Tele	No
CP-LT-762M-20DXT*	M	7'6"	MA-20DX	2BB	290/14, 230/18, 210/20	2-pcs	No
CP-DR-762ML-20DXT*	ML	7'6"	MA-20DX	2BB	290/14, 230/18, 210/20	2-pcs	No
CPDR-862M-30DXT*	M	8'6"	MA-30DX	2BB	510/15, 420/20, 310/25	2-pcs	No
CPCL-862M-45DXT*	M	8'6"	MA-45DX	2BB	580/20, 430/25, 330/30	2-pcs	No
CPC-902MH-30DXT*	MH	9'0"	MA-30DX	2BB	510/15, 420/20, 310/25	2-pcs	No
CP-DD-1002-30DXT*	MH	10'0"	MA-30DX	2BB	510/15, 420/20, 310/25	2-pcs	No

*Line Counter Trolling Models

Ceymar

CEYMAR COMBOS

- UFR: Ultimate Flex Reinforcement technology increases rod's lifting power and maximum strength
- Multi-disc, oiled felt drag system
- 7 BB + 1RB for ultimate smoothness
- 6 BB + 1RB on 10-size reel only
- Quick-Set anti-reverse roller bearing
- Precision machine cut brass pinion gear
- Corrosion-resistant graphite body
- Rigid, forged aluminum, black anodized handle design
- Lightweight, EVA handle knobs for comfort
- Precision Elliptical Gearing system
- Machined aluminum, 2-tone anodized spool
- Heavy duty, solid aluminum bail wire
- RESII: Computer balanced Rotor Equalizing System
- Narrow Blade Body Design for reduced fatigue
- Ceymar Combos are backed by a 1-year warranty

MODEL	PWR	LENGTH (FT)	REEL MODEL	BEARINGS	LINE CAPACITY	SECTIONS	PRE-SPOOLED WITH LINE
CEYMAR COMBOS							
C-662M-30	M	6'6"	C-30	7BB+1RB	200/6, 160/8, 110/10	2-pcs	No
C-702M-30	M	7'0"	C-30	7BB+1RB	200/6, 160/8, 110/10	2-pcs	No
C-602UL-10*	UL	6'0"	C-10	6BB+1RB	210/2, 110/4, 70/6	2-pcs	No

* = Trout Spinning Models



SAFINA PRO

SAFINA PRO SALTWATER COMBOS

- Responsive and durable 24-ton carbon rod blanks
- UFR: Ultimate Flex Reinforced rod tip technology
- Safina Pro reels feature a 3BB+1RB drive system
- CFR: Cyclonic Flow Rotor technology
- Machined aluminum, 2 tone anodized spool
- Feature a precision placed stainless steel hook keeper
- Safina Pro combos are backed by a 1-year limited warranty

MODEL	PWR	LENGTH (FT)	REEL MODEL	BEARINGS	LINE CAPACITY	SECTIONS	PRE-SPOOLED WITH LINE
SAFINA PRO SALTWATER COMBOS							
SNP-S-702ML-3000	ML	7'0"	SNP-3000	3BB+1RB	210/6, 170/8, 140/10	2-pcs	No
SNP-S-702M-3000	M	7'0"	SNP-3000	3BB+1RB	210/6, 170/8, 140/10	2-pcs	No
SNP-S-702MH-4000	MH	7'0"	SNP-4000	3BB+1RB	265/8, 220/10, 185/12	2-pcs	No
SNP-S-762M-3000	M	7'6"	SNP-3000	3BB+1RB	210/6, 170/8, 140/10	2-pcs	No
SNP-S-762MH-4000	MH	7'6"	SNP-4000	3BB+1RB	265/8, 220/10, 185/12	2-pcs	No
SNP-S-802MH-6000	MH	8'0"	SNP-6000	3BB+1RB	280/12, 195/16, 165/20	2-pcs	No
SNP-S-902H-8000	H	9'0"	SNP-8000	3BB+1RB	380/12, 265/16, 225/20	2-pcs	No

S = Spinning Model

Fuel Spin

FUEL SPIN COMBOS

- Responsive and durable 24-ton carbon rod blanks
- Spinning reels feature a 1BB drive system
- Baitcast reels feature a 3BB+1RB drive system
- CFR: Cyclonic Flow Rotor on spinning models
- Polished titanium oxide guide inserts
- External adjustable magnetic cast control: Baitcast models
- Contoured split EVA rear grip for reduced weight
- Fuel Spin combos are backed by a 1-year limited warranty

MODEL	PWR	LENGTH (FT)	REEL MODEL	BEARINGS	LINE CAPACITY	SECTIONS	PRE-SPOOLED WITH LINE
FUEL SPIN SPINNING COMBOS							
FSP-602M-1000	M	6'0"	FSP-1000	1BB	280/2,140/4,110/6	2-pcs	No
FSP-662ML-1000	ML	6'6"	FSP-1000	1BB	280/2,140/4,110/6	2-pcs	No
FSP-662M-3000	M	6'6"	FSP-3000	1BB	240/6,200/8,160/10	2-pcs	No
FSP-702L-1000	L	7'0"	FSP-1000	1BB	280/2,140/4,110/6	2-pcs	No
FSP-702M-3000	M	7'0"	FSP-3000	1BB	240/6,200/8,160/10	2-pcs	No
FUEL SPIN BAITCAST COMBOS							
FSP-701M-100HA	M	7'0"	FSP100H-A	3BB+1RB	120/12,110/14,90/16	1-pcs	No
FSP-701MH-100HA	MH	7'0"	FSP100H-A	3BB+1RB	120/12,110/14,90/16	1-pcs	No



ALARIS

ALARIS COMBO

- 3BB + 1RB bearing drive for durability
- QuickSet anti-reverse roller bearing for hook sets
- Multi-disc oil felt drag washers for ultimate smoothness
- CFR: Cyclonic Flow Rotor technology
- Durable Dura-flow stainless steel guides
- Sensitive graphite composite rod blank construction
- Rear cork split grip with EVA foam foregrip
- Machined aluminum, two-tone anodized spool
- Rigid metal handle design for added strength
- Alaris combos are backed by a 1-year limited warranty

MODEL	PWR	LENGTH (FT)	REEL MODEL	BEARINGS	LINE CAPACITY	SECTIONS	PRE-SPOOLED WITH LINE
ALARIS COMBO							
ALS-S-562L-20	L	5'6"	ALS-20	3BB+1RB	280/2,140/4,110/6	2-pcs	No
ALS-S-602ML-20	ML	6'0"	ALS-20	3BB+1RB	280/2,140/4,110/6	2-pcs	No
ALS-S-662M-30	M	6'6"	ALS-30	3BB+1RB	240/6,200/8,160/10	2-pcs	No
ALS-S-702M-30	M	7'0"	ALS-30	3BB+1RB	240/6,200/8,160/10	2-pcs	No



AVEON

AVEON COMBOS

- Durable and sensitive graphite composite rod blank
- Traditional cork foregrips with full cork butt section
- Multi-disc oil felt drag washers
- Quick-Set ant-reverse bearing
- Machined aluminum, 2-tone anodized spool
- Rigid aluminum handle for improved strength
- Tip over butt ferrule connection for improved feel
- All Aveon rods feature 2-pcs blanks for transportation
- Aveon combos are backed by a 1-year limited warranty

MODEL	PWR	LENGTH (FT)	REEL MODEL	BEARINGS	LINE CAPACITY	SECTIONS	PRE-SPOOLED WITH LINE
AVEON TROUT SPINNING COMBOS							
AE-S-602UL-10	UL	6'0"	AE-10	1BB+1RB	160/4,120/6	2-pcs	No
AE-S-662UL-10	UL	6'6"	AE-10	1BB+1RB	160/4,120/6	2-pcs	No
AE-S-702L-10	L	7'0"	AE-10	1BB+1RB	160/4,120/6	2-pcs	No
AVEON STEELHEAD SPINNING COMBOS							
AE-S-902ML-40	ML	9'0"	AE-40	3BB+1RB	420/6,320/8,260/10	2-pcs	No
AE-S-962ML-40	ML	9'6"	AE-40	3BB+1RB	420/6,320/8,260/10	2-pcs	No
AVEON KOKANEI TROUT TROLLING COMBO							
AE-G-762L-15D	L	7'6"	AE-15D	1BB	330/10,290/12,240/14	2-pcs	No





ROX

ROX COMBOS

- Graphite composite rod blank construction
- 2BB bearing drive for smoothness
- Multi-disc oil felt drag washers
- Durable Dura-flow stainless steel guides
- Comfortable EVA foam fore grips
- Neo-cork rear split grips for reduced weight
- Salmon/Steelhead models feature full Cork grips
- Machined aluminum 2-toned anodized spool
- Rigid aluminum handle for improved strength
- Limited 1-year warranty

MODEL	PWR	LENGTH (FT)	REEL MODEL	BEARINGS	LINE CAPACITY	SECTIONS	PRE-SPOOLED WITH LINE
ROX SPINNING COMBOS							
ROX-702UL-20	UL	7' 0"	ROX-20	2BB	150/4, 120/6	2-pcs	Yes
ROX-602ML-20	ML	6' 0"	ROX-20	2BB	150/4, 120/6	2-pcs	Yes
ROX-662M-30	M	6' 6"	ROX-30	2BB	270/6, 185/10	2-pcs	Yes
ROX-702M-30	M	7' 0"	ROX-30	2BB	270/6, 185/10	2-pcs	Yes
ROX-802M-40	M	8' 0"	ROX-40	2BB	215/10, 160/12	2-pcs	Yes
ROX-862ML-40	ML	8' 6"	ROX-40	2BB	215/10, 160/12	2-pcs	Yes
ROX-902MH-50	MH	9' 0"	ROX-45	2BB	215/10, 160/12, 15/120	2-pcs	Yes
ROX TROLLING COMBOS							
ROX-C-902MH-20DX	MH	9' 0"	ROX-20DX	2BB	290/14, 230/18, 210/20	2-pcs	No

FIN-CHASER

FIN CHASER "X" SERIES COMBOS

- Durable glass fiber rod blank construction
- All models feature a comfortable EVA fore grip
- Rear grip on 6'-7' combos feature split cork
- Rear grips on 8' and larger combos is full EVA
- Multi-disc oil felt drag washers
- All models feature a 1 ball bearing drive system
- Machined aluminum, anodized spool
- Fin Chaser 8' and larger feature double foot guide construction
- All Fin Chaser rods feature 2-pcs blanks for transportation
- Fin Chaser combos are backed by a 1-year limited warranty

	MODEL	PWR	LENGTH (FT)	REEL MODEL	BEARINGS	LINE CAPACITY	SECTIONS	COLOR	PRE-SPOOLED WITH LINE
	FIN CHASER "X" SERIES COMBOS								
	FNX-602-30PK	ML	6' 0"	FNX-30	1BB	310/3, 250/4, 165/6	2-pcs	Pink	Yes
NEW	FNX-602-30SF	ML	6' 0"	FNX-30	1BB	310/3, 250/4, 165/6	2-pcs	Sea Foam	Yes
NEW	FNX-602-30SB	ML	6' 0"	FNX-30	1BB	310/3, 250/4, 165/6	2-pcs	Sky Blue	Yes
	FNX-662-30BL	M	6' 6"	FNX-30	1BB	310/3, 250/4, 165/6	2-pcs	Blue	Yes
	FNX-662-30YL	M	6' 6"	FNX-30	1BB	310/3, 250/4, 165/6	2-pcs	Yellow	Yes
	FNX-662-30PK	M	6' 6"	FNX-30	1BB	310/3, 250/4, 165/6	2-pcs	Pink	Yes
	FNX-662-30SF	M	6' 6"	FNX-30	1BB	310/3, 250/4, 165/6	2-pcs	Sea Foam	Yes
	FNX-662-30SB	M	6' 6"	FNX-30	1BB	310/3, 250/4, 165/6	2-pcs	Sky Blue	Yes
	FNX-70-40PK	MH	7' 0"	FNX-40	1BB	190/10, 140/12, 110/15	2-pcs	Pink	Yes
	FNX-70-40BL	MH	7' 0"	FNX-40	1BB	190/10, 140/12, 110/15	2-pcs	Blue	Yes
	FNX-70-40YL	MH	7' 0"	FNX-40	1BB	190/10, 140/12, 110/15	2-pcs	Yellow	Yes
	FNX-70-40SF	MH	7' 0"	FNX-40	1BB	190/10, 140/12, 110/15	2-pcs	Sea Foam	Yes
	FNX-70-40SB	MH	7' 0"	FNX-40	1BB	190/10, 140/12, 110/15	2-pcs	Sky Blue	Yes
	FNX-80-40BL	MH	8' 0"	FNX-40	1BB	190/10, 140/12, 110/15	2-pcs	Blue	Yes
	FNX-80-40YL	MH	8' 0"	FNX-40	1BB	190/10, 140/12, 110/15	2-pcs	Yellow	Yes
NEW	FNX-80-40SF	MH	8' 0"	FNX-40	1BB	190/10, 140/12, 110/15	2-pcs	Sea Foam	Yes
NEW	FNX-80-40SB	MH	8' 0"	FNX-40	1BB	190/10, 140/12, 110/15	2-pcs	Sky Blue	Yes
	FNX-90-60BL	MH	9' 0"	FNX-60	1BB	155/18, 125/20, 90/30	2-pcs	Blue	Yes
	FNX-90-60YL	MH	9' 0"	FNX-60	1BB	155/18, 125/20, 90/30	2-pcs	Yellow	Yes
NEW	FNX-90-60SF	MH	9' 0"	FNX-60	1BB	155/18, 125/20, 90/30	2-pcs	Sea Foam	Yes
NEW	FNX-90-60SB	MH	9' 0"	FNX-60	1BB	155/18, 125/20, 90/30	2-pcs	Sky Blue	Yes
	FNX-100-65BL	MH	10' 0"	FNX-65	1BB	300/15, 190/20, 130/35	2-pcs	Blue	Yes
	FNX-100-65YL	MH	10' 0"	FNX-65	1BB	300/15, 190/20, 130/35	2-pcs	Yellow	Yes

S = Spinning Model

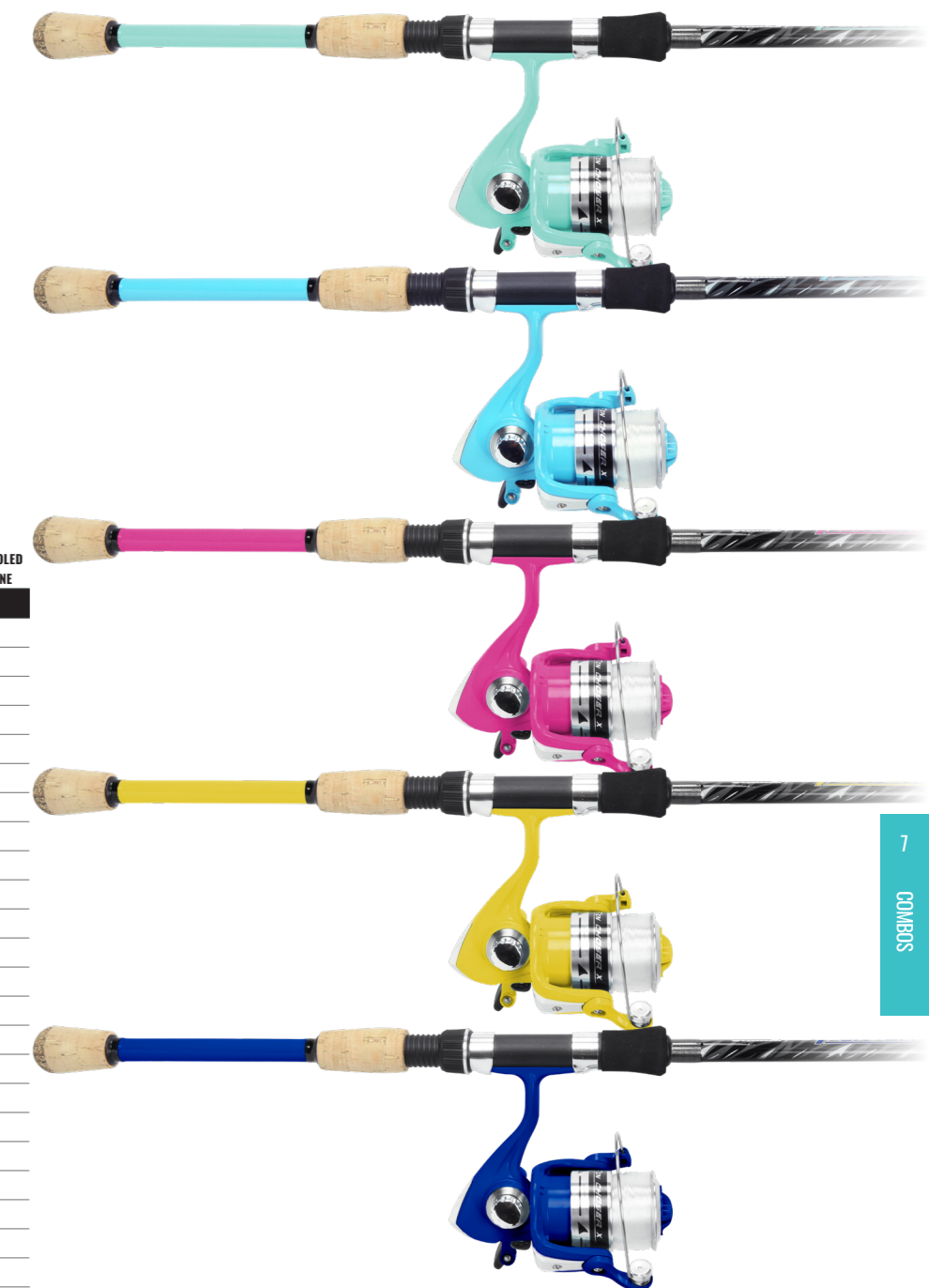



TUNDRA

TUNDRA COMBO

- 1BB ball bearing drive for smoothness
- Corrosion resistant graphite spool
- Multi-disc oiled felt drag system
- Durable glass fiber rod blank construction
- Reinforced double footed guides on all models
- Long lasting ceramic guide inserts
- Stainless steel hooded reel seats
- Comfortable EVA foam fore and rear grips
- Durable rubber butt cap
- Tundra combos are pre-spooled with line
- Limited 1-year warranty

MODEL	PWR	LENGTH (FT)	REEL MODEL	BEARINGS	LINE CAPACITY	SECTIONS	PRE-SPOOLED WITH LINE
TUNDRA COMBO							
TU-702-50	M	7' 0"	TU-50	1BB	440/10, 390/12, 280/15	2-pcs	Yes
TU-802-60	M	8' 0"	TU-60	1BB	360/12, 250/15, 210/20	2-pcs	Yes
TU-902-65	MH	9' 0"	TU-65	1BB	440/12, 310/15, 260/20	2-pcs	Yes
TU-1002-80	MH	10' 0"	TU-80	1BB	430/15, 360/20, 260/25	2-pcs	Yes
TU-1202-80	MH	12' 0"	TU-80	1BB	430/15, 360/20, 260/25	2-pcs	Yes
TBF-702-50*	M	7' 0"	TU-50	1BB	440/10, 390/12, 280/15	2-pcs	Yes
TBF-802-65*	M	8' 0"	TU-65	1BB	540/12, 390/15, 320/20	2-pcs	Yes
TBF-1002-65*	MH	10' 0"	TU-65	1BB	540/12, 390/15, 320/20	2-pcs	Yes

*Baitfeeder Model



TUNDRA PRO

TUNDRA PRO COMBOS

- Durable and sensitive graphite composite rod blank
- UFR: Ultimate Flex Reinforcement rod tip technology
- Comfortable EVA fore and rear grip configuration
- Multi-disc oil felt drag washers
- Features a 3 ball bearing drive system
- Machined aluminum, 2-tone anodized spool
- All Tundra pro guides feature double foot construction
- Tip over butt ferrule connection for improved feel
- All Tundra Pro rods feature 2-pcs blanks for transportation
- Tundra Pro combos are backed by a 1-year limited warranty

MODEL	PWR	LENGTH (FT)	REEL MODEL	BEARINGS	LINE CAPACITY	SECTIONS	PRE-SPOOLED WITH LINE
TUNDRA PRO COMBOS							
TXP-702-50	M	7' 0"	TXP-50	3BB	215/12, 165/15, 105/20	2-pcs	No
TXP-802-60	M	8' 0"	TXP-60	3BB	155/18, 125/20, 90/30	2-pcs	No
TXP-902-65	MH	9' 0"	TXP-65	3BB	300/15, 190/20, 130/35	2-pcs	No
TXP-1002-80	MH	10' 0"	TXP-80	3BB	530/15, 340/20, 210/35	2-pcs	No
TXP-1202-80	MH	12' 0"	TXP-80	3BB	530/15, 340/20, 210/35	2-pcs	No

*Line Counter Trolling Models

Steeles

STEELER XP COMBOS

- Durable glass fiber rod blank construction
- Feature comfortable EVA fore and rear split grip
- Multi-disc front drag washer system
- All models feature a 1 ball bearing drive system
- Reels are pre-spooled with monofilament line
- All Steeler rods are 2-pcs for easy transportation
- Steeler XT combos are backed by a 1-year limited warranty

MODEL	PWR	LENGTH (FT)	REEL MODEL	BEARINGS	LINE CAPACITY	SECTIONS	COLOR	PRE-SPOOLED WITH LINE
STEELER XP COMBOS								
SLXP-562-20BO	M	5'6"	SLXP-20	1BB	265/3, 220/4, 180/6	2-pcs	Orange	Yes
SLXP-562-20GR	M	5'6"	SLXP-20	1BB	265/3, 220/4, 180/6	2-pcs	Green	Yes
SLXP-562-20PK	M	5'6"	SLXP-20	1BB	265/3, 220/4, 180/6	2-pcs	Pink	Yes
SLXP-602-20BO	M	6'0"	SLXP-20	1BB	265/3, 220/4, 180/6	2-pcs	Orange	Yes
SLXP-602-20GR	M	6'0"	SLXP-20	1BB	265/3, 220/4, 180/6	2-pcs	Green	Yes
SLXP-602-20PK	M	6'0"	SLXP-20	1BB	265/3, 220/4, 180/6	2-pcs	Pink	Yes
SLXP-662-20BO	M	6'6"	SLXP-20	1BB	265/3, 220/4, 180/6	2-pcs	Orange	Yes
SLXP-662-20GR	M	6'6"	SLXP-20	1BB	265/3, 220/4, 180/6	2-pcs	Green	Yes
SLXP-662-20PK	M	6'6"	SLXP-20	1BB	265/3, 220/4, 180/6	2-pcs	Pink	Yes



BOUNDARY

BOUNDARY COMBOS

- Narrow modern reel body design
- Corrosion resistant frame, sideplate and rotor
- Electroplated graphite spool design
- Glass fiber rod blank for maximum durability
- 1 Ball Bearing Drive System for smoothness
- Comfortable EVA fore and rear grips on rod
- Rods are all 2-pcs construction for easy transportation
- Limited 1-year warranty

MODEL	PWR	LENGTH (FT)	REEL MODEL	BEARINGS	LINE CAPACITY	SECTIONS	PRE-SPOOLED WITH LINE
BOUNDARY COMBOS							
B-S-602-20	M	6'0"	B-20	1BB	330/6, 260/8, 180/10	2-pcs	Yes
B-S-662-30	M	6'6"	B-30	1BB	330/6, 260/8, 180/10	2-pcs	Yes
B-S-702-40	M	7'0"	B-40	1BB	410/8, 290/10, 260/12	2-pcs	Yes
B-S-802-40	MH	8'0"	B-40	1BB	410/8, 290/10, 260/12	2-pcs	Yes
B-S-902-65	MH	9'0"	B-65	1BB	440/12, 310/15, 260/20	2-pcs	Yes
B-S-1002-65	MH	10'0"	B-65	1BB	440/12, 310/15, 260/20	2-pcs	Yes



CASCADE II

CASCADE II COMBOS

- Durable glass fiber rod blank construction
- Features comfortable EVA fore grips
- Rear grip is split configuration EVA and cork
- Multi-disc front drag washer system
- All models feature a 1 ball bearing drive system
- Reels are pre-spooled with monofilament line
- All Cascade rods are 2-pcs for easy transportation
- Cascade II combos backed by a 1-year limited warranty

MODEL	PWR	LENGTH (FT)	REEL MODEL	BEARINGS	LINE CAPACITY	SECTIONS	PRE-SPOOLED WITH LINE
CASCADE II COMBOS							
CSII-502L-20	L	5'0"	CSII-20	1BB	265/3, 220/4, 180/6	2-pcs	Yes
CSII-562ML-20	ML	5'6"	CSII-20	1BB	265/3, 220/4, 180/6	2-pcs	Yes
CSII-602ML-20	ML	6'0"	CSII-20	1BB	265/3, 220/4, 180/6	2-pcs	Yes
CSII-662ML-20	ML	6'6"	CSII-20	1BB	265/3, 220/4, 180/6	2-pcs	Yes





ACCESSORIES & APPAREL

The ultimate companion pieces to Okuma fishing rods and reels, and Okuma accessories add quality to the details of the experience. Universally, our fabrics and construction elements are top-of-the-line. The specific features are the culmination of experience and the understanding that you cannot catch fish if your gear is not in the water. Organization and accessibility are paramount. All of our accessories are built to fish hard, offering the most hard-core enthusiast a product which delivers extensive pride of ownership and long-lasting durability.



CAL'S UNIVERSAL DRAG REEL GREASE

- Maximum corrosion protection
- Fortified with teflon and polymers
- Little to no drag acceleration
- Exceptionally smooth drag performance
- Superior heat and wear resistance
- Safe on all metals and common plastics
- Reduces gear train friction for easier cranking



POLAR-X REEL GREASE

Okuma's Polar-X Reel Grease is formulated to drastically increase the performance of your fishing reel in extreme temperatures. Suitable for low and high temperatures between -58°F (-50°C) and +284°F (+140°C), its low viscosity provides superior lubrication and long lasting performance.

ACCESSORIES

MODEL	DESCRIPTION
CG-30G	Cal's universal drag and gear grease 30grams
CG-100G	Cal's universal drag and gear grease 100grams
RMK-3010	Cal's universal grease 30grams with 10ML of Fishing Reel oil
XG-30	Polar X Reel Grease
ACL-BB	Line cutter and lanyard combo pack



ACCESSORIES

MODEL	CLEAR POCKETS	WRAP DIMENSIONS
REEL COVERS		
ARS-BC	Reel Shield-Neoprene reel cover	All 200-size low profile baitcast reels
ARS-1	Reel Shield-Neoprene reel cover	150/250/400 round baitcasting & 15/20/200 star drag reels
ARS-2	Reel Shield-Neoprene reel cover	10/15 lever drags & 30/40/300/450 star drag reels
ARS-3	Reel Shield-Neoprene reel cover	20/30 sized lever drag reels & 55/55W star drag reels
ARS-4	Reel Shield-Neoprene reel cover	50/50W sized lever drag reels
ARS-10	Fly Reel Covers-Neoprene	All Okuma fly reels
ARS-15	Fly and Float Reel Cover	8-11 wt. fly reels and Okuma float reels
ROD STRAPS		
AS-RW	Okuma Rod Wraps-Durable Velcro style rod strap with logo	All Rods
OKEECHOBEE HANDLE		
AROPH-1	Okeechobee Baitcast Power Handle	200/350-size Low Profile reels
ARCWTH	350-size paddle handle	350-size Low profile reels



OKUMA WARRANTY

We at Okuma take great pride in the workmanship and quality of our products. We also take great pride in taking care of our customers. Should you require service for your Okuma rod or reel, we have a nationwide network of Authorized Repair Centers, or our full service warranty at Okuma, to help take care of you. You may also visit our Web site at www.okumafishing.com for more information and to register your products.

OKUMA WARRANTY REPAIR

NAME	PHONE	ADDRESS	CITY	STATE	POSTAL CODE
B&J Sporting Goods	907-274-6113	113 W Northern Lights Blvd Suite J/K	Anchorage	AK	99503
4 Reel Services Inc.	561-509-9055	410 N Dixie Hwy	Lantana	FL	33462
Dave's Parts & Service	727-942-8944	1500 U.S. Hwy 19	Holiday	FL	34691
Tuna's Reel Troubles	231-907-0052	78 North Nelson Road	Ludington	MI	49431
The Reel Seat	732-223-5353	707 Union Ave.	Brielle	NJ	8730
Roy's Bait & Tackle Outfitters	361-992-2960	7613 South Padre Island Dr.	Corpus Christi	TX	78412

CANADIAN WARRANTY CENTERS

NAME	PHONE	ADDRESS	CITY	STATE	POSTAL CODE
Mike's Reel Repair	604-855-1119	45910 Rowat Ave., #208	Chilliwack	BC	V2P 1J3
Country Rod Crafting	250-468-5708	3709 Remora Place	Nanoose Bay	BC	V9P 9H1
Rockey's Tackle Service	705-325-3526	3 Royce Ave Unit 1 & 2	Orillia	ON	L3V 5H3
MG Reel Solution	450-436-0395	304 Lancelot	Saint Columban	QB	JOR 1K0

AUTHORIZED REPAIR CENTERS

NAME	PHONE	ADDRESS	CITY	STATE	POSTAL CODE
B&J Sporting Goods	907-274-6113	113 W Northern Lights Blvd Suite J/K	Anchorage	AK	99503
Mark's Outdoor Sports	205-822-2010	1400-B Montgomery Highway	Birmingham	AL	35216
Rock Springs Tackle	870-741-7375	1902 Rock Springs Road	Harrison	AR	92601
B&F Rod and Reel	909-988-9229	1028 W. 4th St.	Ontario	CA	91762
Dana Landing Sportsfishing	619-226-2929	2580 Ingraham St.	San Diego	CA	92109
Fisherman's Warehouse	916-362-1200	9035 Folsom Blvd	Sacramento	CA	95826
Pacific Extreme Sports	916-646-3474	4701 24th St. Suite D	Sacramento	CA	95822
Fisherman's World	203-866-1075	2 Fort Point St.	Norwalk	CT	06855
Fishing Factory	860-621-8145	1426 Meriden-Waterbury Road	Milldale	CT	06467
Old Inlet Bait & Tackle	302-227-7974	Highway 1, Box 129	Rehoboth Beach	DE	19971
Rick's Bait & Tackle	302-945-9245	26019 Julius Lane	Millsboro	DE	19966
Billy's Rod and Reel Repair	850-382-3047	4887 W Spencer Field Rd.	Pace	FL	32571
Dave's Parts & Service	727-942-8944	1500 U.S. Hwy 19	Holiday	FL	34691
Lost Key Tackle LLC	850-361-1145	12890 Gulf Beach Hwy	Pensacola	FL	32507
Broadway Tackle	706-738-8848	1730 Broad Street	Augusta	GA	30904
Nutter Rod & Reel	770-386-3978	3383 Highway 411 NE	White	GA	30184
New Maui Fishing Supply	808-244-3449	1823 Wells Street Suite 4	Wailuku	HI	96793
Roy's Fishing Supply	808-487-7690	98-025 Hekaha Street	Aiea	HI	96701
S. Tokunaga Store	808-935-6965	26 Hoku Street	Hilo	HI	96720
Bob's Reel Service	319-362-7692	3945 Rollingwood Drive NW	Cedar Rapids	IA	52405
Glenn's Reel & Rod Repair	515-262-2990	2210 E 9th Street	Des Moines	IA	50316
Kay's Rod & Reel Repair	563-535-7108	1511 Scenic Valley Road	Waukon	IA	52172
Glenn's Rod and Reel LLC	985-223-2188	2755 Coteau Rd.	Houma	LA	70364
Professional Sports Shop	504-522-3771	920 Julia St.	New Orleans	LA	70113
Superior Bait & Tackle	225-293-3474	5760 Siegen Lane Suite D	Baton Rouge	LA	70809
Bucko's Parts & Tackle	508-674-7900	191 Stafford Road	Fall River	MA	02721
Reel Easy Custom Rods	978-476-7187	68 Curzon Mill Rd.	Newburyport	MA	01950
Blue Fin's bait and tackle	410-477-9244	701 Wise ave.	Baltimore	MD	21222
Reel Perfection	410-676-0027	324 Flying Point Road	Edgewood	MD	21040

AUTHORIZED REPAIR CENTERS CONT.

NAME	PHONE	ADDRESS	CITY	STATE	POSTAL CODE
Tuna's Reel Troubles	231-907-0052	78 North Nelson Road	Ludington	MI	49431
367 Bait and Tackle	314-653-1377	11841 Benham Rd.	St. Louis	MO	63138
Bryant's Osage Outdoors	573-374-2278	716 N. Main St.	Laurie	MO	65037
Paul's Bait & Tackle	314773-6221	4421 Chippewa	St. Louis	MO	63116
Betty & Nick's Bait & Tackle	732-793-2708	807 S.W. Central Avenue	Seaside Park	NJ	08752
Capt'n Hippo Bait & Tackle	735--505-3500	334 Atlantic City Blvd	South Toms River	NJ	08757
The Reel Seat	732-223-5353	707 Union Ave.	Brielle	NJ	08730
Bill's Hooks	716-366-0268	5139 W. Lake Road	Dunkirk	NY	14048
Road Runner Reel Repair	405-201-7801	212 North Rush st.	RUSH SPRINGS	OK	73082
Fat Boys Bait & Tackle	262-536-4374	228 North Franklin St	Port Washington	OR	53074
Jim Pringles Reel Repair	541-535-3509	4329 Wildwood Drive	Medford	OR	97501
Ollie Damon's	503-232-3193	236 SE Grand Ave	Portland	OR	97214
Fish USA	412-384-4500	6960 West Ridge Rd	Fairview	PA	16415
Carolina Reels	864-231-5914	1017 Bern Circle	Anderson	SC	29626
ADCO Reel Repair	409- 625-4409	Rt1 Box 1740 Hwy 21	East Hemphill	TX	75948
DadsOleTackle	936-264-4167	16245 FM 1484 RD	Conroe	TX	77303
David's Tackle Box	281-3429669	3500 Avenue I	Rosenberg	TX	77471
Olsen's Pro AM	817- 625-0831	3020 Roberts Cut Off Rd.	Ft. Worth	TX	76114
Roy's Bait & Tackle Outfitters	361-992-2960	7613 South Padre Island Dr.	Corpus Christi	TX	78412
Serious Tackle Equities L.L.C.	409-935-1126	14065 Delaney Road	Lamarque	TX	77568
Tackle Right	903- 850-8292	8251 W. FM 515	Yantis	TX	75497
The Fisherman's Place	361- 687-6754	3911 Ayers	Corpus Christi	TX	78415
Howie's Tackle	920-746-9916	1309 Green Bay Rd.	Sturgeon Bay	WI	54235
Mat's Reel Repair	715-571-7544	1930 Pinewood Drive	Eagle River	WI	54521
The Bait Box	262-284-9355	3781 County Road KW	Eagle River	WI	54521
Riverside Fly & Tackle	604-944-2479	2847 Shaughnessy St.	Port Coquitlam	BC	V3C 3H1



OKUMA SALES REPRESENTATIVES

Please feel free to contact your local sales representative for more information on Okuma and our products, or visit our website at www.okumafishingusa.com.

- | | | |
|---|--|--|
| <p>1. Active Outdoors
4230 SE King Rd PMB 198
Milwaukie OR 97222
Tel: (503) 968-2828 Fax: (503) 662-7670</p> | <p>4. SLA Outdoors
334 East Colfax-Suite A-1
Palatine, IL 60067
Tel: (847) 991-6119 Fax: (847) 991-6207</p> | <p>7. Outdoor Marketing Group, Inc.
157 Harvest Lane, PO Box 781
Denton, NC 27239
Tel: (336) 859-2297</p> |
| <p>2. Schooler Associates
P.O. Box 2336
Albany, Texas 76430
Tel: (325) 762-3686 Fax: (325) 762-3009</p> | <p>5. Canada Pro Angling & Outdoors
2869 Bloor St W. Suite 1440
Toronto, ON M8X 1B3
Tel: (416) 253-1405 Fax: (416) 253-0504</p> | <p>8. Zale Outdoors
52 Chemin du Fort
Saint-Hippolyte, QC J8A 0G8
Tel: (450) 675-3305</p> |
| <p>3. Thomas F. Gowen & Sons
1040 Old Sproul Rd.
Springfield, PA 19064
Tel: (610) 544-3700 Fax: (610) 328-6820</p> | <p>6. Pro Line Sports Ltd
31707 Israel ave
Mission, BC V4S 1E4
Tel: (604) 814-2161</p> | |

okuma

INSPIRED FISHING

www.okumafishingusa.com

KEEPAMERICA
FISHING.ORG



CATALOG23-OKUMA



OKUMA FISHING TACKLE
Tel: (800)GO-OKUMA
2310 E. Locust Ct.
Ontario, CA 91761